



**DAC7624  
DAC7625**



## 12-Bit Quad Voltage Output DIGITAL-TO-ANALOG CONVERTER

### FEATURES

- **LOW POWER:** 20mW
- **UNIPOLAR OR BIPOLAR OPERATION**
- **SETTLING TIME:** 10 $\mu$ s to 0.012%
- **12-BIT LINEARITY AND MONOTONICITY:**  $-40^{\circ}\text{C}$  to  $+85^{\circ}\text{C}$
- **RESET TO MID-SCALE (DAC7624) OR ZERO-SCALE (DAC7625)**
- **DATA READBACK**
- **DOUBLE-BUFFERED DATA INPUTS**

### APPLICATIONS

- **PROCESS CONTROL**
- **ATE PIN ELECTRONICS**
- **CLOSED-LOOP SERVO-CONTROL**
- **MOTOR CONTROL**
- **DATA ACQUISITION SYSTEMS**
- **DAC-PER-PIN PROGRAMMERS**

### DESCRIPTION

The DAC7624 and DAC7625 are 12-bit quad voltage output digital-to-analog converters with guaranteed 12-bit monotonic performance over the specified temperature range. They accept 12-bit parallel input data, have double-buffered DAC input logic (allowing simultaneous update of all DACs), and provide a readback mode of the internal input registers. An asynchronous reset clears all registers to a mid-scale code of  $800_{\text{H}}$  (DAC7624) or to a zero-scale of  $000_{\text{H}}$  (DAC7625). The DAC7624 and DAC7625 can operate from a single +5V supply or from +5V and -5V supplies.

Low power and small size per DAC make the DAC7624 and DAC7625 ideal for automatic test equipment, DAC-per-pin programmers, data acquisition systems, and closed-loop servo-control. The DAC7624 and DAC7625 are available in a 28-pin plastic double-wide or a 28-lead SOIC package, and offer guaranteed specifications over the  $-40^{\circ}\text{C}$  to  $+85^{\circ}\text{C}$  temperature range.

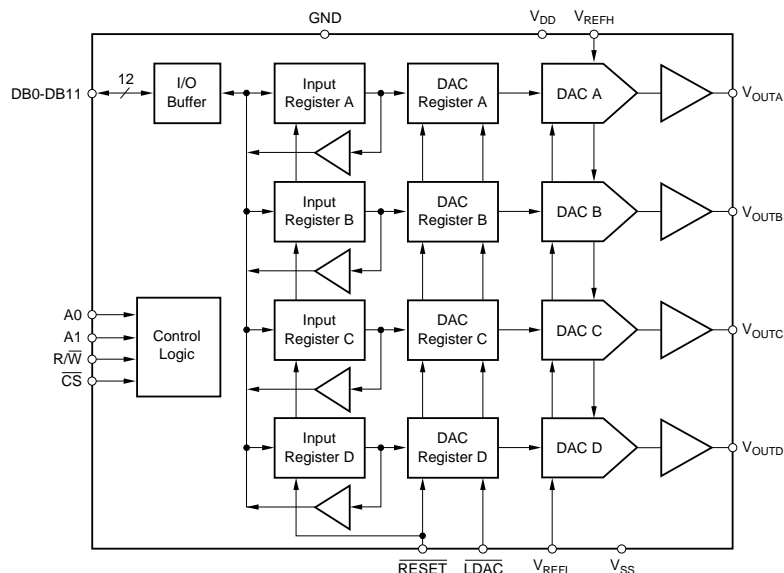

International Airport Industrial Park • Mailing Address: PO Box 11400, Tucson, AZ 85734 • Street Address: 6730 S. Tucson Blvd., Tucson, AZ 85706 • Tel: (520) 746-1111 • Twx: 910-952-1111  
Internet: <http://www.burr-brown.com/> • FAXLine: (800) 548-6133 (US/Canada Only) • Cable: BBRCORP • Telex: 066-6491 • FAX: (520) 889-1510 • Immediate Product Info: (800) 548-6132

# SPECIFICATION

At  $T_A = -40^\circ\text{C}$  to  $+85^\circ\text{C}$ ,  $V_{DD} = +5\text{V}$ ,  $V_{SS} = -5\text{V}$ ,  $V_{REFH} = +2.5\text{V}$ ,  $V_{REFL} = -2.5\text{V}$ , unless otherwise noted.

| PARAMETER                          | CONDITIONS   | DAC7624P, U<br>DAC7625P, U |           |                                   | DAC7624PB, UB<br>DAC7625PB, UB |     |         | UNITS                  |
|------------------------------------|--|----------------------------|-----------|-----------------------------------|--------------------------------|-----|---------|------------------------|
|                                    |  | MIN                        | TYP       | MAX                               | MIN                            | TYP | MAX     |                        |
| <b>ACCURACY</b>                    |  |                            |           |                                   |                                |     |         |                        |
| Linearity Error <sup>(1)</sup>     | $V_{SS} = 0\text{V}$ or $-5\text{V}$                                   |                            |           | $\pm 2$                           |                                |     | $\pm 1$ | LSB <sup>(2)</sup>     |
| Linearity Matching <sup>(3)</sup>  | $V_{SS} = 0\text{V}$ or $-5\text{V}$                                   |                            |           | $\pm 2$                           |                                |     | $\pm 1$ | LSB                    |
| Differential Linearity Error       | $V_{SS} = 0\text{V}$ or $-5\text{V}$                                   |                            |           | $\pm 1$                           |                                |     | $\pm 1$ | LSB                    |
| Monotonicity                       | $T_{MIN}$ to $T_{MAX}$   | 12                         |           |                                   | *                              |     | *       | Bits                   |
| Zero-Scale Error                   | Code = $000_H$   |                            |           | $\pm 4$                           |                                |     | *       | LSB                    |
| Zero-Scale Drift                   |  |                            | 2         | 5                                 |                                | *   | *       | ppm/ $^\circ\text{C}$  |
| Zero-Scale Matching <sup>(3)</sup> |  |                            |           | $\pm 2$                           |                                |     | $\pm 1$ | LSB                    |
| Full-Scale Error                   | Code = $FFF_H$   |                            |           | $\pm 4$                           |                                |     | *       | LS                     |
| Full-Scale Matching <sup>(3)</sup> |  |                            |           | $\pm 2$                           |                                |     | $\pm 1$ | LSB                    |
| Zero-Scale Error                   | Code = $00A_H$ , $V_{SS} = 0\text{V}$                                  |                            |           | $\pm 8$                           |                                |     | *       | LSB                    |
| Zero-Scale Drift                   | $V_{SS} = 0\text{V}$   |                            | 5         | 10                                |                                | *   | *       | ppm/ $^\circ\text{C}$  |
| Zero-Scale Matching <sup>(3)</sup> | $V_{SS} = 0\text{V}$   |                            |           | $\pm 4$                           |                                |     | $\pm 2$ | LSB                    |
| Full-Scale Error                   | Code = $FFF_H$ , $V_{SS} = 0\text{V}$                                  |                            |           | $\pm 8$                           |                                |     | *       | LSB                    |
| Full-Scale Matching <sup>(3)</sup> | $V_{SS} = 0\text{V}$   |                            |           | $\pm 4$                           |                                |     | $\pm 2$ | LSB                    |
| Power Supply Rejection             |  |                            | 30        |                                   |                                | *   |         | ppm/V                  |
| <b>ANALOG OUTPUT</b>               |  |                            |           |                                   |                                |     |         |                        |
| Voltage Output <sup>(4)</sup>      | $V_{REFL} = 0\text{V}$ , $V_{SS} = 0\text{V}$<br>$V_{SS} = -5\text{V}$ | 0<br>$V_{REFL}$<br>-1.25   |           | $V_{REFH}$<br>$V_{REFH}$<br>+1.25 | *                              |     | *       | V<br>V<br>mA           |
| Output Current                     |  |                            |           |                                   |                                |     | *       | mA                     |
| Load Capacitance                   | No Oscillation   |                            | 100       |                                   |                                | *   | *       | pF                     |
| Short-Circuit Current              |  |                            | +5, -120  |                                   |                                | *   | *       | mA                     |
| Short-Circuit Duration             |  |                            | Momentary |                                   |                                | *   | *       |                        |
| <b>REFERENCE INPUT</b>             |  |                            |           |                                   |                                |     |         |                        |
| $V_{REFH}$ Input Range             | $V_{SS} = 0\text{V}$ or $-5\text{V}$                                   | $V_{REFL} + 1.25$          |           | +2.5                              | *                              |     | *       | V                      |
| $V_{REFL}$ Input Range             | $V_{SS} = 0\text{V}$   | 0                          |           | $V_{REFH} - 1.25$                 | *                              |     | *       | V                      |
| $V_{REFL}$ Input Range             | $V_{SS} = -5\text{V}$  | -2.5                       |           | $V_{REFH} - 1.25$                 | *                              |     | *       | V                      |
| <b>DYNAMIC PERFORMANCE</b>         |  |                            |           |                                   |                                |     |         |                        |
| Settling Time <sup>(5)</sup>       | To $\pm 0.012\%$   |                            | 5         | 10                                |                                | *   | *       | $\mu\text{s}$          |
| Channel-to-Channel Crosstalk       | Full-Scale Step<br>On any other DAC                                    |                            | 0.25      |                                   |                                | *   | *       | LSB                    |
| Output Noise Voltage               | 0Hz to 1MHz  |                            | 40        |                                   |                                | *   | *       | nV/ $\sqrt{\text{Hz}}$ |
| <b>DIGITAL INPUT/OUTPUT</b>        |  |                            |           |                                   |                                |     |         |                        |
| Logic Family                       |  | TTL-Compatible CMOS        |           |                                   |                                |     | *       |                        |
| Logic Levels                       |  |                            |           |                                   |                                |     |         |                        |
| $V_{IH}$                           | $I_{IH} \leq \pm 10\mu\text{A}$  | 2.4                        |           | $V_{DD} + 0.3$                    | *                              |     | *       | V                      |
| $V_{IL}$                           | $I_{IL} \leq \pm 10\mu\text{A}$  | -0.3                       |           | 0.8                               | *                              |     | *       | V                      |
| $V_{OH}$                           | $I_{OH} = -0.8\text{mA}$   | 3.6                        |           | $V_{DD}$                          | *                              |     | *       | V                      |
| $V_{OL}$                           | $I_{OL} = 1.6\text{mA}$  | 0.0                        |           | 0.4                               | *                              |     | *       | V                      |
| Data Format                        |  | Straight Binary            |           |                                   |                                |     | *       |                        |
| <b>POWER SUPPLY REQUIREMENTS</b>   |  |                            |           |                                   |                                |     |         |                        |
| $V_{DD}$                           |  | 4.75                       |           | 5.25                              | *                              |     | *       | V                      |
| $V_{SS}$                           | If $V_{SS} \neq 0\text{V}$   | -5.25                      |           | -4.75                             | *                              |     | *       | V                      |
| $I_{DD}$                           |  |                            | 1.5       | 1.9                               |                                | *   | *       | mA                     |
| $I_{SS}$                           |  | -2.1                       | -1.6      |                                   | *                              | *   | *       | mA                     |
| Power Dissipation                  | $V_{SS} = -5\text{V}$  |                            | 15        | 20                                |                                | *   | *       | mW                     |
|                                    | $V_{SS} = 0\text{V}$   |                            | 7.5       | 10                                |                                | *   | *       | mW                     |
| <b>TEMPERATURE RANGE</b>           |  |                            |           |                                   |                                |     |         |                        |
| Specified Performance              | DAC7624P, U, PB, UB<br>DAC7625P, U, PB, UB                             | -40                        |           | +85                               | *                              |     | *       | $^\circ\text{C}$       |

NOTES: (1) If  $V_{SS} = 0\text{V}$ , specification applies at code  $00A_H$  and above. (2) LSB means Least Significant Bit, when  $V_{REFH}$  equals  $+2.5\text{V}$  and  $V_{REFL}$  equals  $-2.5\text{V}$ , then one LSB equals  $1.22\text{mV}$ . (3) All DAC outputs will match within the specified error band. (4) Ideal output voltage, does not take into account zero or full-scale error. (5) If  $V_{SS} = -5\text{V}$ , full-scale  $5\text{V}$  step. If  $V_{SS} = 0\text{V}$ , full-scale positive  $2.5\text{V}$  step and negative step from code  $FFF_H$  to  $00A_H$ .

The information provided herein is believed to be reliable; however, BURR-BROWN assumes no responsibility for inaccuracies or omissions. BURR-BROWN assumes no responsibility for the use of this information, and all use of such information shall be entirely at the user's own risk. Prices and specifications are subject to change without notice. No patent rights or licenses to any of the circuits described herein are implied or granted to any third party. BURR-BROWN does not authorize or warrant any BURR-BROWN product for use in life support devices and/or systems.

## ABSOLUTE MAXIMUM RATINGS<sup>(1)</sup>

|   |                                |
|---|--------------------------------|
| $V_{DD}$ to $V_{SS}$ .....              | -0.3V to 11V                   |
| $V_{DD}$ to GND .....                   | -0.3V to 5.5V                  |
| $V_{REFL}$ to $V_{SS}$ .....            | -0.3V to ( $V_{DD} - V_{SS}$ ) |
| $V_{DD}$ to $V_{REFH}$ .....            | -0.3V to ( $V_{DD} - V_{SS}$ ) |
| $V_{REFH}$ to $V_{REFL}$ .....          | -0.3V to ( $V_{DD} - V_{SS}$ ) |
| Digital Input Voltage to GND .....      | -0.3V to $V_{DD} + 0.3V$       |
| Digital Output Voltage to GND .....     | -0.3V to $V_{DD} + 0.3V$       |
| Maximum Junction Temperature .....      | +150°C                         |
| Operating Temperature Range .....       | -40°C to +85°C                 |
| Storage Temperature Range .....         | -65°C to +150°C                |
| Lead Temperature (soldering, 10s) ..... | +300°C                         |

NOTE: (1) Stresses above those listed under "Absolute Maximum Ratings" may cause permanent damage to the device. Exposure to absolute maximum conditions for extended periods may affect device reliability.



## ELECTROSTATIC DISCHARGE SENSITIVITY

This integrated circuit can be damaged by ESD. Burr-Brown recommends that all integrated circuits be handled with appropriate precautions. Failure to observe proper handling and installation procedures can cause damage.

ESD damage can range from subtle performance degradation to complete device failure. Precision integrated circuits may be more susceptible to damage because very small parametric changes could cause the device not to meet its published specifications.

## PACKAGE/ORDERING INFORMATION

| PRODUCT   | MAXIMUM LINEARITY ERROR (LSB) | MAXIMUM DIFFERENTIAL LINEARITY ERROR (LSB) | SPECIFICATION TEMPERATURE RANGE | PACKAGE            | PACKAGE DRAWING NUMBER <sup>(1)</sup> |
|-----------|-------------------------------|--|---------------------------------|--------------------|---------------------------------------|
| DAC7624P  | ±2                            | ±1   | -40°C to +85°C                  | 28-Pin Plastic DIP | 215                                   |
| DAC7624U  | ±2                            | ±1   | -40°C to +85°C                  | 28-Lead SOIC       | 217                                   |
| DAC7624PB | ±1                            | ±1   | -40°C to +85°C                  | 28-Pin Plastic DIP | 215                                   |
| DAC7624UB | ±1                            | ±1   | -40°C to +85°C                  | 28-Lead SOIC       | 217                                   |
| DAC7625P  | ±2                            | ±1   | -40°C to +85°C                  | 28-Pin Plastic DIP | 215                                   |
| DAC7625U  | ±2                            | ±1   | -40°C to +85°C                  | 28-Lead SOIC       | 217                                   |
| DAC7625PB | ±1                            | ±1   | -40°C to +85°C                  | 28-Pin Plastic DIP | 215                                   |
| DAC7625UB | ±1                            | ±1   | -40°C to +85°C                  | 28-Lead SOIC       | 217                                   |

NOTE: (1) For detailed drawing and dimension table, please see end of data sheet, or Appendix C of Burr-Brown IC Data Book.

## PIN CONFIGURATIONS

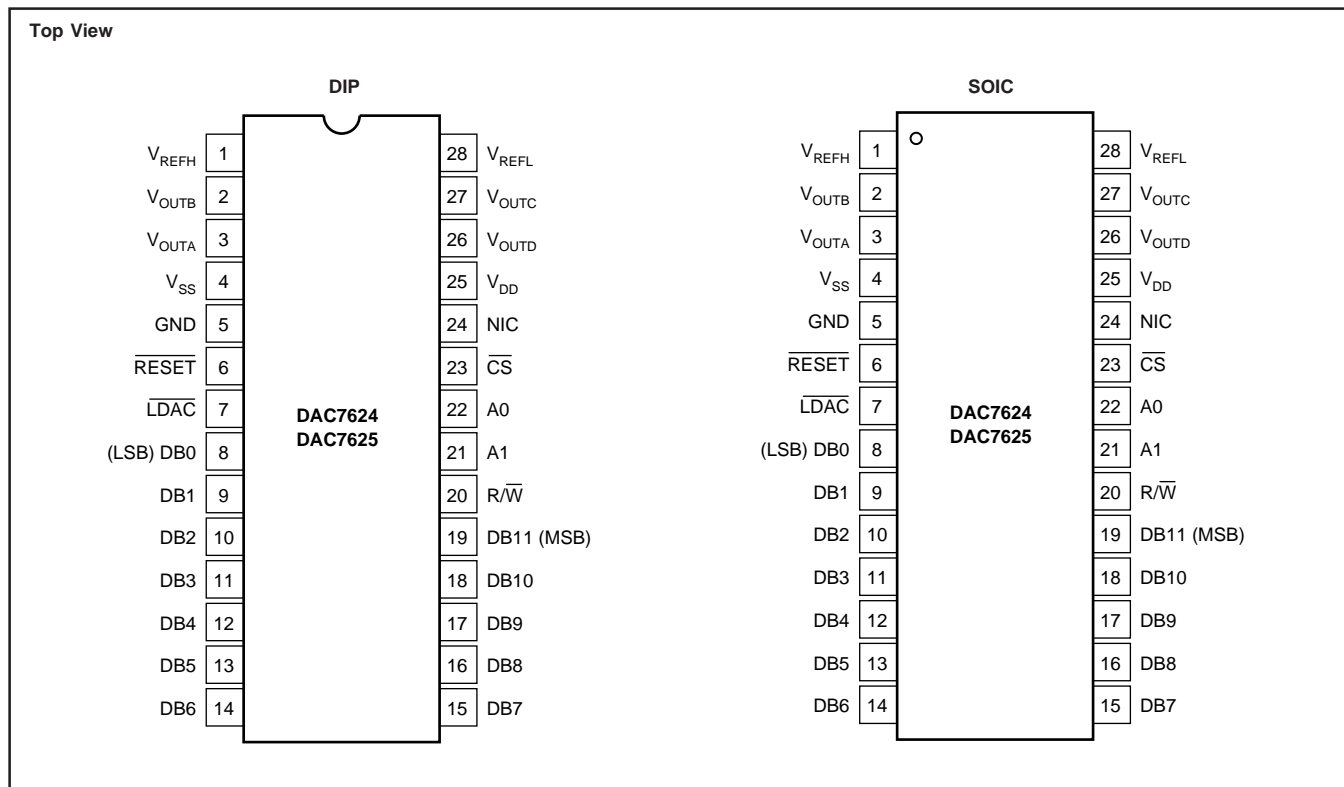

## PIN DESCRIPTIONS

| PIN | NAME              | DESCRIPTION  |
|-----|-------------------|--|
| 1   | V <sub>REFH</sub> | Reference Input Voltage High. Sets maximum output voltage for all DACs.  |
| 2   | V <sub>OUTB</sub> | DAC B Voltage Output.  |
| 3   | V <sub>OUTA</sub> | DAC A Voltage Output.  |
| 4   | V <sub>SS</sub>   | Negative Analog Supply Voltage, 0V or -5V.   |
| 5   | GND               | Ground.  |
| 6   | RESET             | Asynchronous Reset Input. Sets DAC and input registers to either mid-scale (800 <sub>H</sub> , DAC7624) or zero-scale (000 <sub>H</sub> , DAC7625) when LOW. |
| 7   | LDAC              | Load DAC Input. All DAC Registers are transparent when LOW.  |
| 8   | DB0               | Data Bit 0. Least significant bit of 12-bit word.  |
| 9   | DB1               | Data Bit 1   |
| 10  | DB2               | Data Bit 2   |
| 11  | DB3               | Data Bit 3   |
| 12  | DB4               | Data Bit 4   |
| 13  | DB5               | Data Bit 5   |
| 14  | DB6               | Data Bit 6   |
| 15  | DB7               | Data Bit 7   |
| 16  | DB8               | Data Bit 8   |
| 17  | DB9               | Data Bit 9   |
| 18  | DB10              | Data Bit 10  |
| 19  | DB11              | Data Bit 11. Most significant bit of 12-bit word.  |
| 20  | R/W               | Read/Write Control Input (read = HIGH, write = LOW).   |
| 21  | A1                | Register/DAC Select (C or D = HIGH, A or B = LOW).   |
| 22  | A0                | Register/DAC Select (B or D = HIGH, A or C = LOW).   |
| 23  | CS                | Chip Select Input.   |
| 24  | NIC               | Not Internally Connected. Pin has no internal connection to the device.  |
| 25  | V <sub>DD</sub>   | Positive Analog Supply Voltage, +5V nominal.   |
| 26  | V <sub>OUTD</sub> | DAC D Voltage Output.  |
| 27  | V <sub>OUTC</sub> | DAC C Voltage Output.  |
| 28  | V <sub>REFL</sub> | Reference Input Voltage Low. Sets minimum output voltage for all DACs.   |

# TYPICAL PERFORMANCE CURVES: $V_{SS} = 0V$

At  $T_A = +25^\circ C$ ,  $V_{DD} = +5V$ ,  $V_{SS} = 0V$ ,  $V_{REFH} = +2.5V$ ,  $V_{REFL} = 0V$ , representative unit, unless otherwise specified.

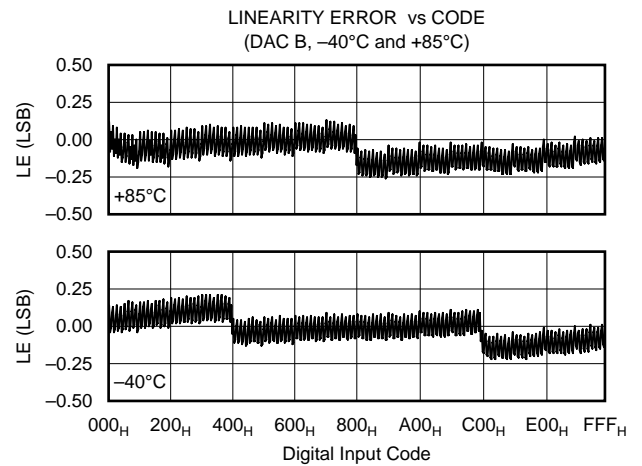
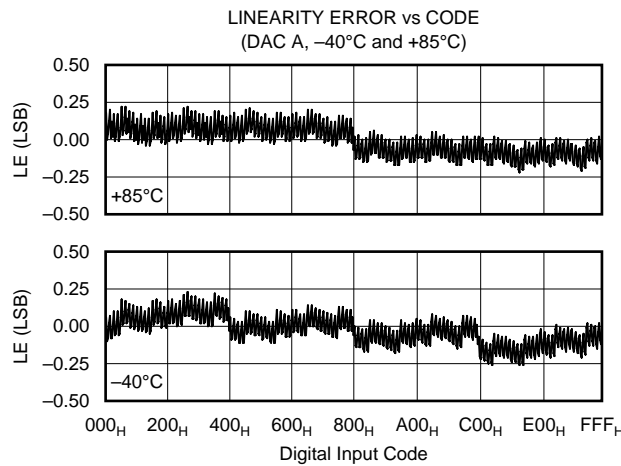
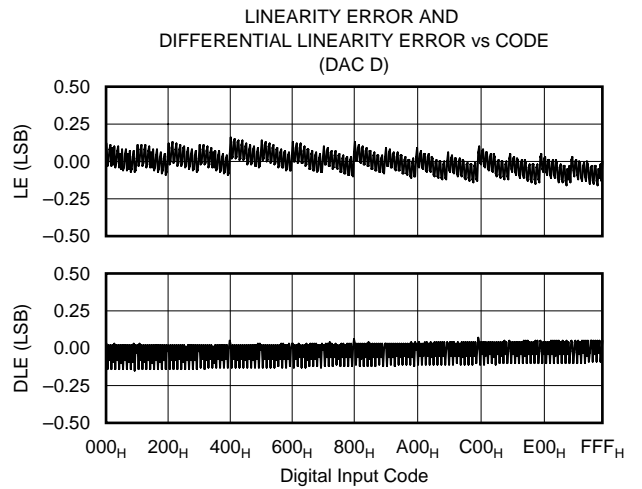
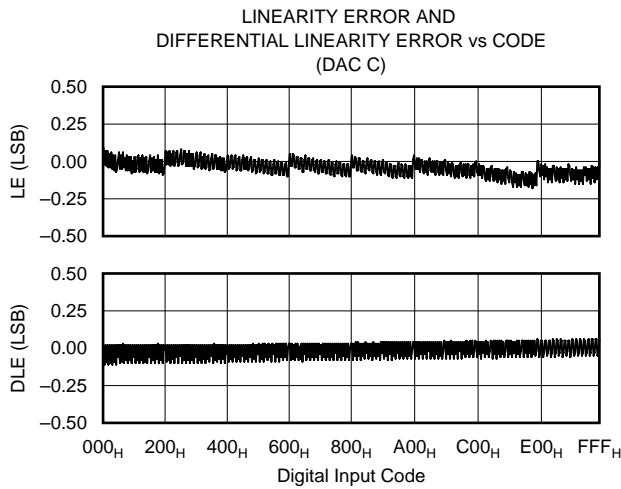
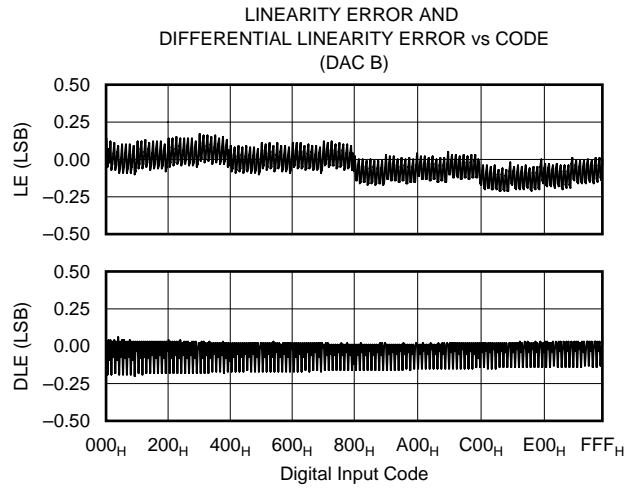
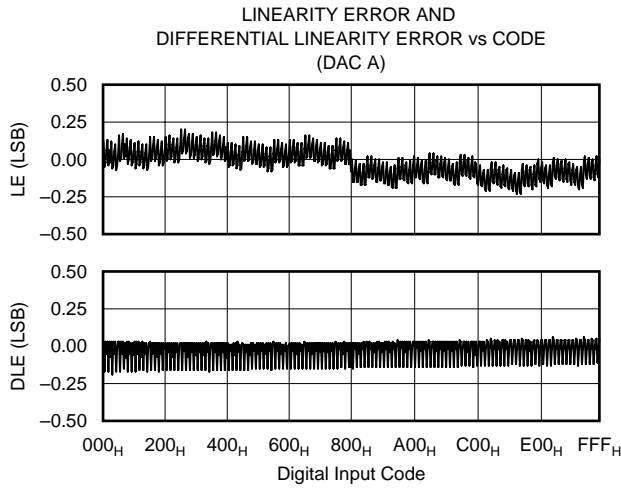

# TYPICAL PERFORMANCE CURVES: $V_{SS} = 0V$ (CONT)

At  $T_A = +25^\circ C$ ,  $V_{DD} = +5V$ ,  $V_{SS} = 0V$ ,  $V_{REFH} = +2.5V$ ,  $V_{REFL} = 0V$ , representative unit, unless otherwise specified.

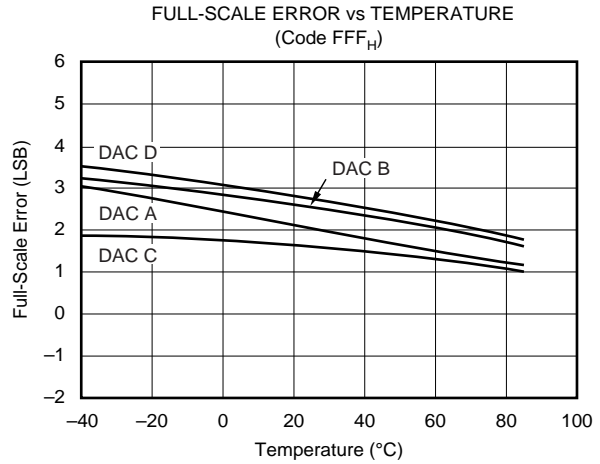
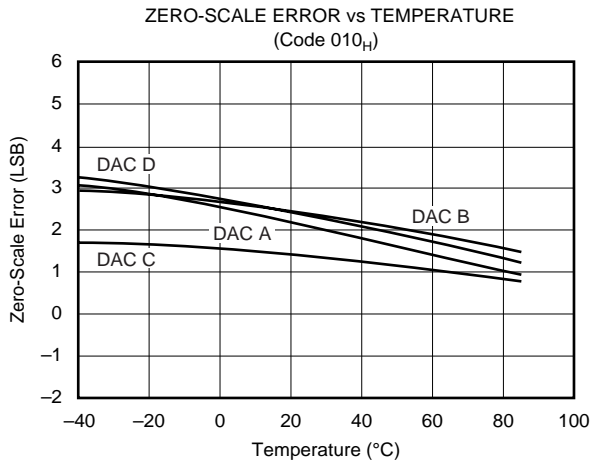
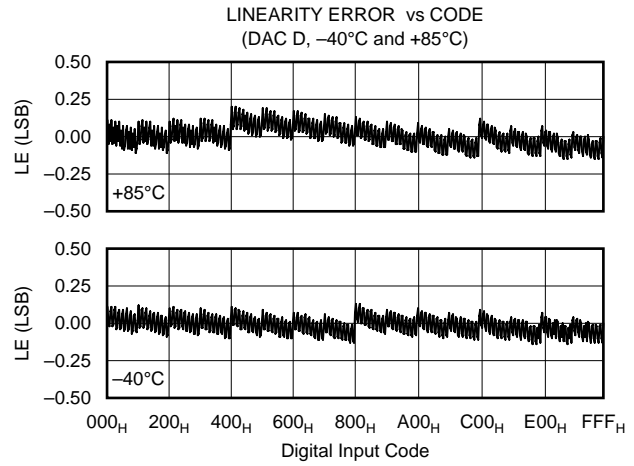
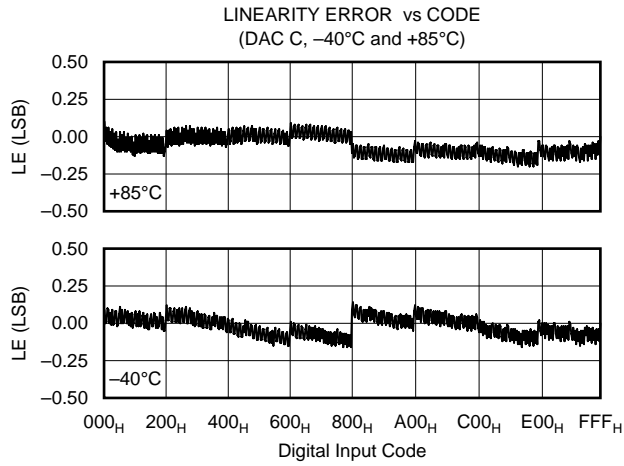

# TYPICAL PERFORMANCE CURVES: $V_{SS} = -5V$

At  $T_A = +25^\circ C$ ,  $V_{DD} = +5V$ ,  $V_{SS} = -5V$ ,  $V_{REFH} = +2.5V$ ,  $V_{REFL} = -2.5V$ , representative unit, unless otherwise specified.

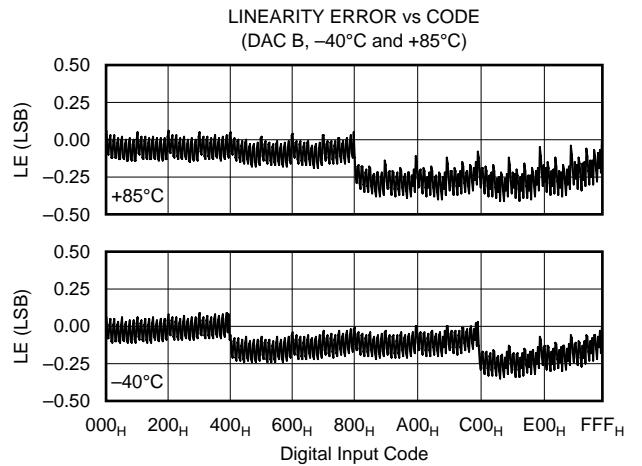
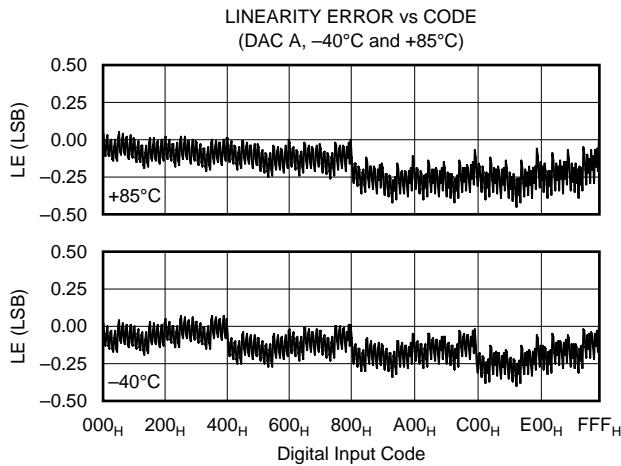
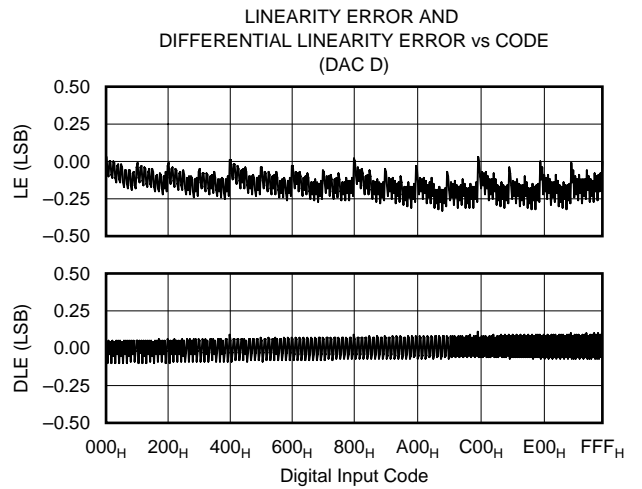
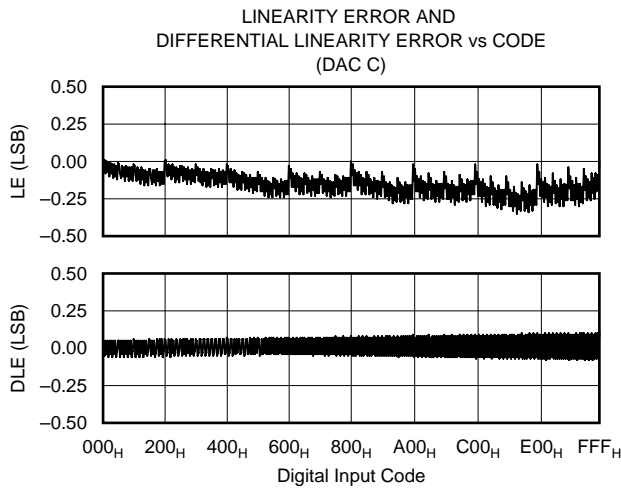
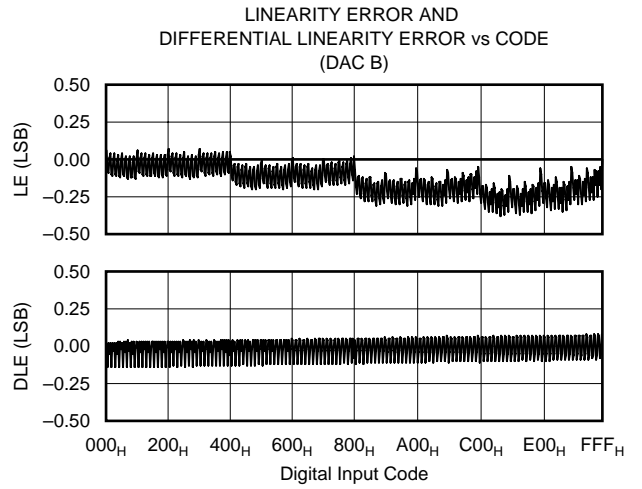
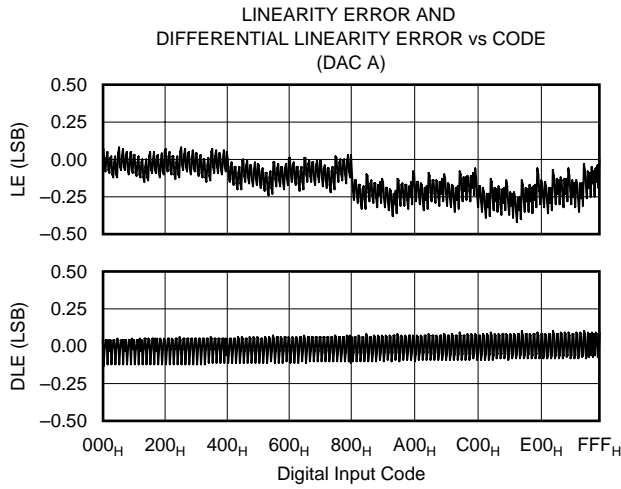

# TYPICAL PERFORMANCE CURVES: $V_{SS} = -5V$ (CONT)

At  $T_A = +25^\circ C$ ,  $V_{DD} = +5V$ ,  $V_{SS} = -5V$ ,  $V_{REFH} = +2.5V$ ,  $V_{REFL} = -2.5V$ , representative unit, unless otherwise specified.

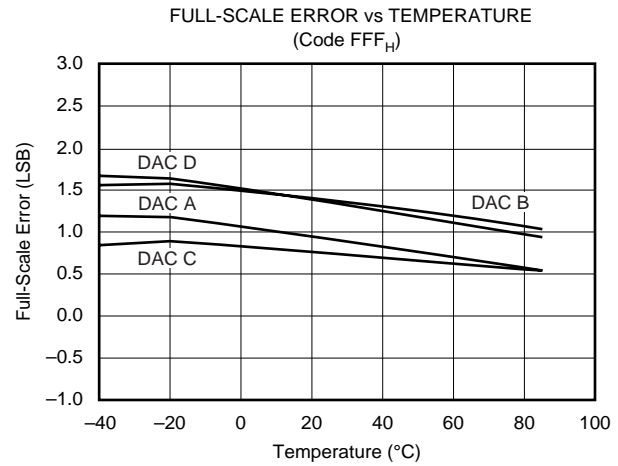
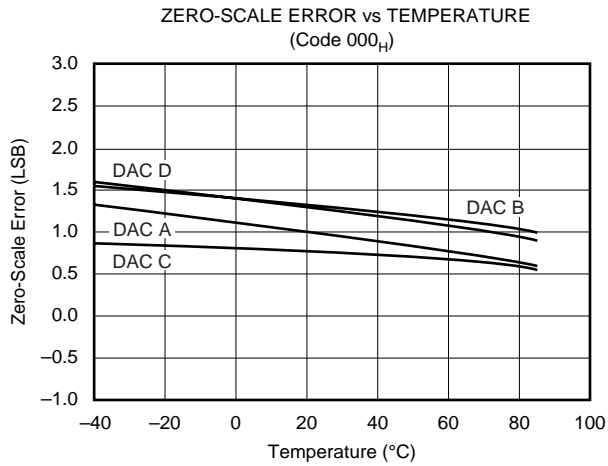
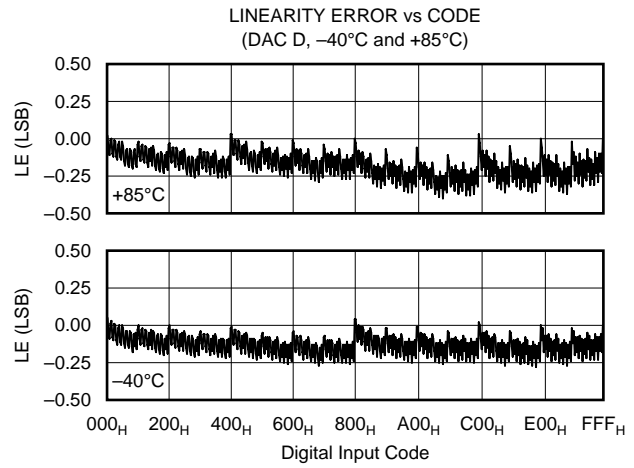
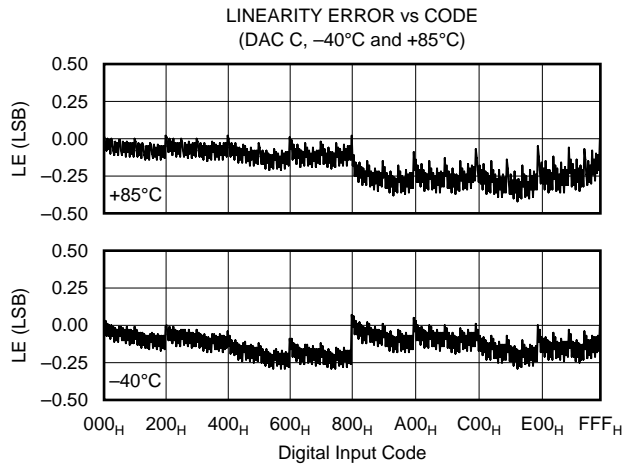

# THEORY OF OPERATION

The DAC7624 and DAC7625 are quad, voltage output, 12-bit digital-to-analog converters (DACs). The architecture is a classic R-2R ladder configuration followed by an operational amplifier that serves as a buffer. Each DAC has its own R-2R ladder network and output op-amp, but all share the reference voltage inputs. The minimum voltage output (“zero-scale”) and maximum voltage output (“full-scale”)

are set by the external voltage references ( $V_{REFL}$  and  $V_{REFH}$ , respectively). The digital input is a 12-bit parallel word and the DAC input registers offer a readback capability. The converters can be powered from a single +5V supply or a dual  $\pm 5V$  supply. Each device offers a reset function which immediately sets all DAC output voltages and DAC registers to mid-scale (DAC7624, code  $800_H$ ) or to zero-scale (DAC7625, code  $000_H$ ). See Figures 1 and 2 for the basic operation of the DAC7624/25.

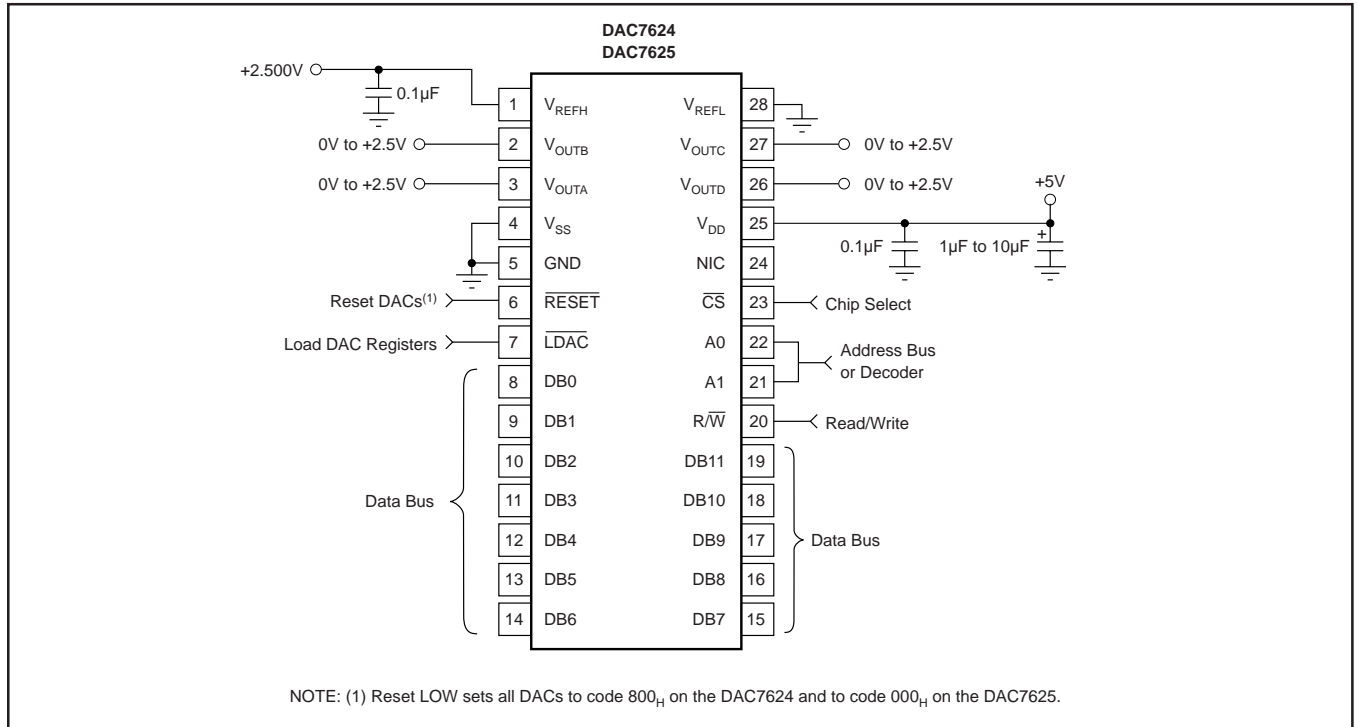

FIGURE 1. Basic Single-Supply Operation of the DAC7624/25.

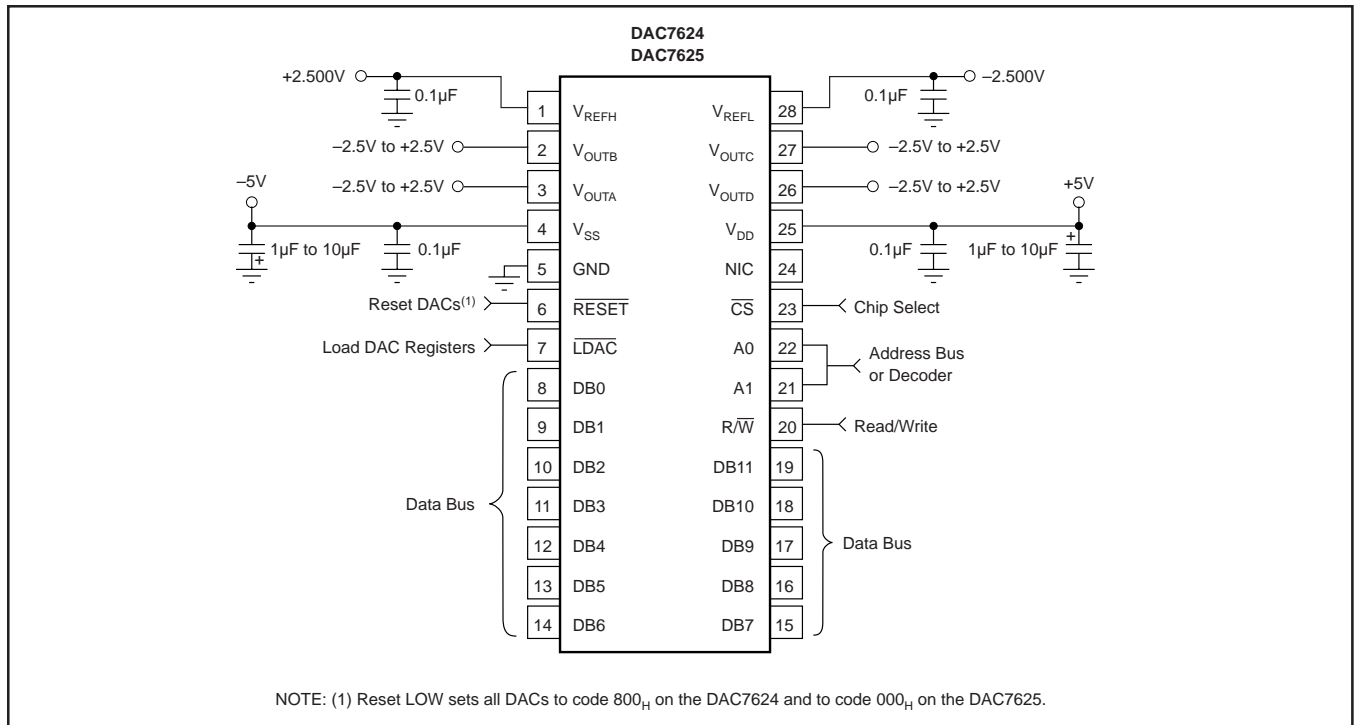

FIGURE 2. Basic Dual-Supply Operation of the DAC7624/25.

## ANALOG OUTPUTS

When  $V_{SS} = -5V$  (dual supply operation), the output amplifier can swing to within 2.25V of the supply rails, guaranteed over the  $-40^{\circ}C$  to  $+85^{\circ}C$  temperature range. With  $V_{SS} = 0V$  (single-supply operation), the output can swing to ground. Note that the settling time of the output op-amp will be longer with voltages very near ground. Also, care must be taken when measuring the zero-scale error when  $V_{SS} = 0V$ . Since the output voltage cannot swing below ground, the output voltage may not change for the first few digital input codes (000<sub>H</sub>, 001<sub>H</sub>, 002<sub>H</sub>, etc.) if the output amplifier has a negative offset.

The behavior of the output amplifier can be critical in some applications. Under short circuit conditions (DAC output shorted to ground), the output amplifier can sink a great deal more current than it can source. See the specification table for more details concerning short circuit current.

## REFERENCE INPUTS

The reference inputs,  $V_{REFL}$  and  $V_{REFH}$ , can be any voltage between  $V_{SS}+2.25V$  and  $V_{DD}-2.25V$  provided that  $V_{REFH}$  is at least 1.25V greater than  $V_{REFL}$ . The minimum output of each DAC is equal to  $V_{REFL}$  plus a small offset voltage (essentially, the offset of the output op-amp). The maximum output is equal to  $V_{REFH}$  plus a similar offset voltage. Note that  $V_{SS}$  (the negative power supply) must either be connected to ground or must be in the range of  $-4.75V$  to  $-5.25V$ . The voltage on  $V_{SS}$  sets several bias points within the converter, if  $V_{SS}$  is not in one of these two configurations, the bias values may be in error and proper operation of the device is not guaranteed.

The current into the  $V_{REFH}$  input depends on the DAC output voltages and can vary from a few microamps to approximately 0.5 milliamp. The  $V_{REFH}$  source will not be required to sink current, only source it. Bypassing the reference voltage or voltages with at least a 0.1uF capacitor placed as close to the DAC7624/25 package is strongly recommended.

## DIGITAL INTERFACE

Table I shows the basic control logic for the DAC7624/25. Note that each internal register is level triggered and not edge triggered. When the appropriate signal is LOW, the register becomes transparent. When this signal is returned HIGH, the digital word currently in the register is latched. The first set of registers (the Input Registers) are triggered via the A0, A1, R/W, and  $\overline{CS}$  inputs. Only one of these registers is transparent at any given time. The second set of registers (the DAC Registers) are all transparent when  $\overline{LDAC}$  input is pulled LOW.

Each DAC can be updated independently by writing to the appropriate Input Register and then updating the DAC Register. Alternatively, the entire DAC Register set can be configured as always transparent by keeping  $\overline{LDAC}$  LOW—the DAC update will occur when the Input Register is written.

The double buffered architecture is mainly designed so that each DAC Input Register can be written at any time and then all DAC voltages updated simultaneously by pulling  $\overline{LDAC}$  LOW. It also allows a DAC Input Register to be written to at any point and the DAC voltage to be synchronously changed via a trigger signal connected to  $\overline{LDAC}$ .

| A1               | A0 | R/W | $\overline{CS}$ | $\overline{RESET}$ | $\overline{LDAC}$ | SELECTED INPUT REGISTER | STATE OF SELECTED INPUT REGISTER | STATE OF ALL DAC REGISTERS |
|------------------|----|-----|-----------------|--------------------|-------------------|-------------------------|----------------------------------|----------------------------|
| L <sup>(1)</sup> | L  | L   | L               | H <sup>(2)</sup>   | L                 | A                       | Transparent                      | Transparent                |
| L                | H  | L   | L               | H                  | L                 | B                       | Transparent                      | Transparent                |
| H                | L  | L   | L               | H                  | L                 | C                       | Transparent                      | Transparent                |
| H                | H  | L   | L               | H                  | L                 | D                       | Transparent                      | Transparent                |
| L                | L  | L   | L               | H                  | H                 | A                       | Transparent                      | Latched                    |
| L                | H  | L   | L               | H                  | H                 | B                       | Transparent                      | Latched                    |
| H                | L  | L   | L               | H                  | H                 | C                       | Transparent                      | Latched                    |
| H                | H  | L   | L               | H                  | H                 | D                       | Transparent                      | Latched                    |
| L                | L  | H   | L               | H                  | H                 | A                       | Readback                         | Latched                    |
| L                | H  | H   | L               | H                  | H                 | B                       | Readback                         | Latched                    |
| H                | L  | H   | L               | H                  | H                 | C                       | Readback                         | Latched                    |
| H                | H  | H   | L               | H                  | H                 | D                       | Readback                         | Latched                    |
| X <sup>(3)</sup> | X  | X   | H               | H                  | L                 | NONE                    | (All Latched)                    | Transparent                |
| X                | X  | X   | H               | H                  | H                 | NONE                    | (All Latched)                    | Latched                    |
| X                | X  | X   | X               | L                  | X                 | ALL                     | Reset <sup>(4)</sup>             | Reset <sup>(4)</sup>       |

NOTES: (1) L = Logic LOW. (2) H = Logic HIGH. (3) X = Don't Care. (4) DAC7624 resets to 800<sub>H</sub>, DAC7625 resets to 000<sub>H</sub>. When  $\overline{RESET}$  rises, all registers that are in their latched state retain the reset value.

TABLE I. DAC7624 and DAC7625 Control Logic Truth Table.

## DIGITAL TIMING

Figure 3 and Table II provide detailed timing for the digital interface of the DAC7624 and DAC7625.

## DIGITAL INPUT CODING

The DAC7624 and DAC7625 input data is in straight binary format. The output voltage is given by the following equation:

$$V_{OUT} = V_{REFL} + \frac{(V_{REFH} - V_{REFL}) \cdot N}{4096}$$

where N is the digital input code. This equation does not include the effects of offset (zero-scale) or gain (full-scale) errors.

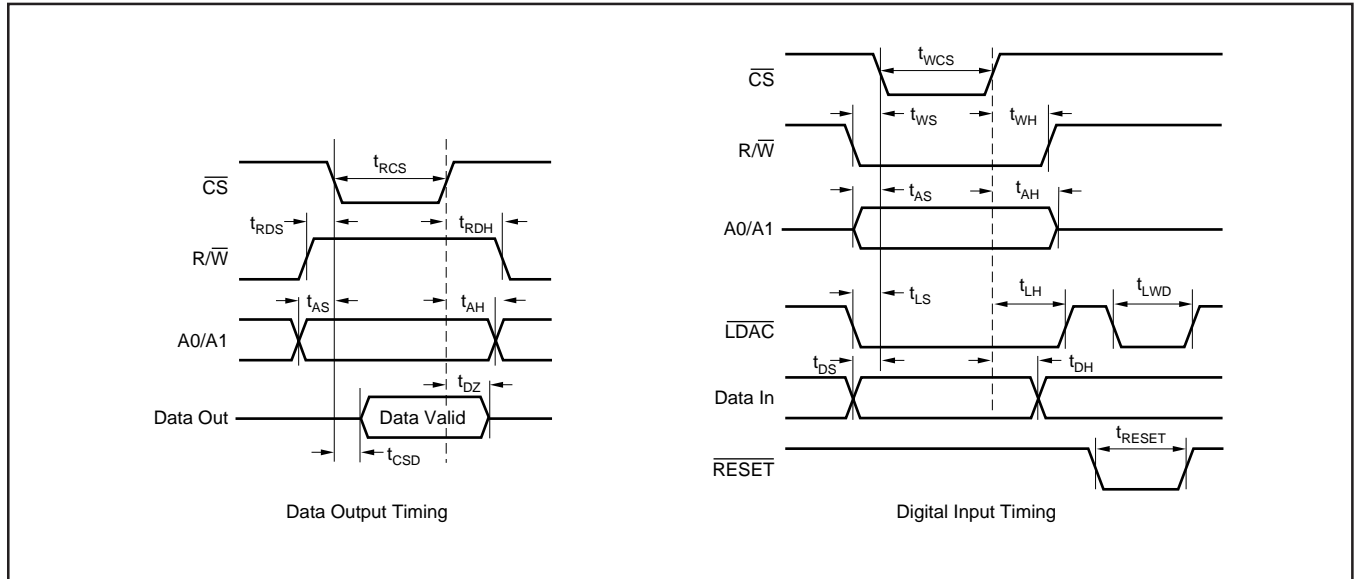

FIGURE 3. Digital Input and Output Timing.

| SYMBOL      | DESCRIPTION   | MIN | TYP | MAX | UNITS |
|-------------|---|-----|-----|-----|-------|
| $t_{RCS}$   | $\overline{CS}$ LOW for Read                                | 200 |     |     | ns    |
| $t_{RDS}$   | $\overline{R/\overline{W}}$ HIGH to $\overline{CS}$ LOW     | 10  |     |     | ns    |
| $t_{RDH}$   | $\overline{R/\overline{W}}$ HIGH after $\overline{CS}$ HIGH | 0   |     |     | ns    |
| $t_{DZ}$    | $\overline{CS}$ HIGH to Data Bus in High Impedance          |     | 100 |     | ns    |
| $t_{CSD}$   | $\overline{CS}$ LOW to Data Bus Valid                       |     | 100 | 160 | ns    |
| $t_{WCS}$   | $\overline{CS}$ LOW for Write                               | 50  |     |     | ns    |
| $t_{WS}$    | $\overline{R/\overline{W}}$ LOW to $\overline{CS}$ LOW      | 0   |     |     | ns    |
| $t_{WH}$    | $\overline{R/\overline{W}}$ LOW after $\overline{CS}$ HIGH  | 0   |     |     | ns    |
| $t_{AS}$    | Address Valid to $\overline{CS}$ LOW                        | 0   |     |     | ns    |
| $t_{AH}$    | Address Valid after $\overline{CS}$ HIGH                    | 0   |     |     | ns    |
| $t_{LS}$    | $\overline{LDAC}$ LOW to $\overline{CS}$ LOW                | 70  |     |     | ns    |
| $t_{LH}$    | $\overline{LDAC}$ LOW after $\overline{CS}$ HIGH            | 50  |     |     | ns    |
| $t_{DS}$    | Data Valid to $\overline{CS}$ LOW                           | 0   |     |     | ns    |
| $t_{DH}$    | Data Valid after $\overline{CS}$ HIGH                       | 0   |     |     | ns    |
| $t_{LWD}$   | $\overline{LDAC}$ LOW                                       | 50  |     |     | ns    |
| $t_{RESET}$ | $\overline{RESET}$ LOW                                      | 50  |     |     | ns    |

TABLE II. Timing Specifications ( $T_A = -40^\circ\text{C}$  to  $+85^\circ\text{C}$ ).

**PACKAGING INFORMATION**

| Orderable Device | Status<br>(1) | Package Type | Package Drawing | Pins | Package Qty | Eco Plan<br>(2) | Lead finish/<br>Ball material<br>(6) | MSL Peak Temp<br>(3) | Op Temp (°C) | Device Marking<br>(4/5) | Samples                 |
|------------------|---------------|--------------|-----------------|------|-------------|-----------------|--------------------------------------|----------------------|--------------|-------------------------|-------------------------|
| DAC7624U         | ACTIVE        | SOIC         | DW              | 28   | 20          | RoHS & Green    | NIPDAU-DCC                           | Level-3-260C-168 HR  | -40 to 85    | DAC7624U                | <a href="#">Samples</a> |
| DAC7624U/1K      | ACTIVE        | SOIC         | DW              | 28   | 1000        | RoHS & Green    | NIPDAU-DCC                           | Level-3-260C-168 HR  | -40 to 85    | DAC7624U                | <a href="#">Samples</a> |
| DAC7624U/1KG4    | ACTIVE        | SOIC         | DW              | 28   | 1000        | RoHS & Green    | NIPDAU-DCC                           | Level-3-260C-168 HR  | -40 to 85    | DAC7624U                | <a href="#">Samples</a> |
| DAC7624UB        | ACTIVE        | SOIC         | DW              | 28   | 20          | RoHS & Green    | NIPDAU-DCC                           | Level-3-260C-168 HR  | -40 to 85    | DAC7624U<br>B           | <a href="#">Samples</a> |
| DAC7624UB/1K     | ACTIVE        | SOIC         | DW              | 28   | 1000        | RoHS & Green    | NIPDAU-DCC                           | Level-3-260C-168 HR  | -40 to 85    | DAC7624U<br>B           | <a href="#">Samples</a> |
| DAC7625U         | ACTIVE        | SOIC         | DW              | 28   | 20          | RoHS & Green    | NIPDAU-DCC                           | Level-3-260C-168 HR  | -40 to 85    | DAC7625U                | <a href="#">Samples</a> |
| DAC7625U/1K      | ACTIVE        | SOIC         | DW              | 28   | 1000        | RoHS & Green    | NIPDAU-DCC                           | Level-3-260C-168 HR  | -40 to 85    | DAC7625U                | <a href="#">Samples</a> |
| DAC7625U/1KG4    | ACTIVE        | SOIC         | DW              | 28   | 1000        | RoHS & Green    | NIPDAU-DCC                           | Level-3-260C-168 HR  | -40 to 85    | DAC7625U                | <a href="#">Samples</a> |
| DAC7625UB        | ACTIVE        | SOIC         | DW              | 28   | 20          | RoHS & Green    | NIPDAU-DCC                           | Level-3-260C-168 HR  | -40 to 85    | DAC7625U<br>B           | <a href="#">Samples</a> |
| DAC7625UB/1K     | ACTIVE        | SOIC         | DW              | 28   | 1000        | RoHS & Green    | NIPDAU-DCC                           | Level-3-260C-168 HR  | -40 to 85    | DAC7625U<br>B           | <a href="#">Samples</a> |

(1) The marketing status values are defined as follows:

**ACTIVE:** Product device recommended for new designs.

**LIFEBUY:** TI has announced that the device will be discontinued, and a lifetime-buy period is in effect.

**NRND:** Not recommended for new designs. Device is in production to support existing customers, but TI does not recommend using this part in a new design.

**PREVIEW:** Device has been announced but is not in production. Samples may or may not be available.

**OBSELETE:** TI has discontinued the production of the device.

(2) **RoHS:** TI defines "RoHS" to mean semiconductor products that are compliant with the current EU RoHS requirements for all 10 RoHS substances, including the requirement that RoHS substance do not exceed 0.1% by weight in homogeneous materials. Where designed to be soldered at high temperatures, "RoHS" products are suitable for use in specified lead-free processes. TI may reference these types of products as "Pb-Free".

**RoHS Exempt:** TI defines "RoHS Exempt" to mean products that contain lead but are compliant with EU RoHS pursuant to a specific EU RoHS exemption.

**Green:** TI defines "Green" to mean the content of Chlorine (Cl) and Bromine (Br) based flame retardants meet JS709B low halogen requirements of <=1000ppm threshold. Antimony trioxide based flame retardants must also meet the <=1000ppm threshold requirement.

(3) MSL, Peak Temp. - The Moisture Sensitivity Level rating according to the JEDEC industry standard classifications, and peak solder temperature.

- (4) There may be additional marking, which relates to the logo, the lot trace code information, or the environmental category on the device.
- (5) Multiple Device Markings will be inside parentheses. Only one Device Marking contained in parentheses and separated by a "~" will appear on a device. If a line is indented then it is a continuation of the previous line and the two combined represent the entire Device Marking for that device.
- (6) Lead finish/Ball material - Orderable Devices may have multiple material finish options. Finish options are separated by a vertical ruled line. Lead finish/Ball material values may wrap to two lines if the finish value exceeds the maximum column width.

**Important Information and Disclaimer:**The information provided on this page represents TI's knowledge and belief as of the date that it is provided. TI bases its knowledge and belief on information provided by third parties, and makes no representation or warranty as to the accuracy of such information. Efforts are underway to better integrate information from third parties. TI has taken and continues to take reasonable steps to provide representative and accurate information but may not have conducted destructive testing or chemical analysis on incoming materials and chemicals. TI and TI suppliers consider certain information to be proprietary, and thus CAS numbers and other limited information may not be available for release.

In no event shall TI's liability arising out of such information exceed the total purchase price of the TI part(s) at issue in this document sold by TI to Customer on an annual basis.

**TAPE AND REEL INFORMATION**

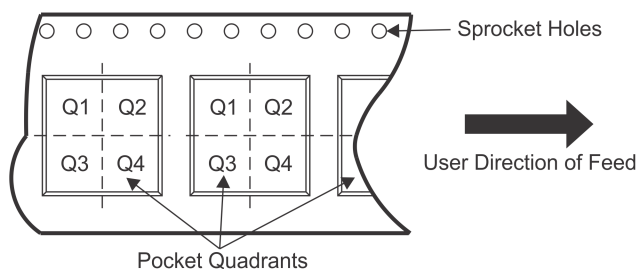
**QUADRANT ASSIGNMENTS FOR PIN 1 ORIENTATION IN TAPE**

\*All dimensions are nominal

| Device       | Package Type | Package Drawing | Pins | SPQ  | Reel Diameter (mm) | Reel Width W1 (mm) | A0 (mm) | B0 (mm) | K0 (mm) | P1 (mm) | W (mm) | Pin1 Quadrant |
|--------------|--------------|-----------------|------|------|--------------------|--------------------|---------|---------|---------|---------|--------|---------------|
| DAC7624U/1K  | SOIC         | DW              | 28   | 1000 | 330.0              | 32.4               | 11.35   | 18.67   | 3.1     | 16.0    | 32.0   | Q1            |
| DAC7624UB/1K | SOIC         | DW              | 28   | 1000 | 330.0              | 32.4               | 11.35   | 18.67   | 3.1     | 16.0    | 32.0   | Q1            |
| DAC7625U/1K  | SOIC         | DW              | 28   | 1000 | 330.0              | 32.4               | 11.35   | 18.67   | 3.1     | 16.0    | 32.0   | Q1            |
| DAC7625UB/1K | SOIC         | DW              | 28   | 1000 | 330.0              | 32.4               | 11.35   | 18.67   | 3.1     | 16.0    | 32.0   | Q1            |

**TAPE AND REEL BOX DIMENSIONS**

\*All dimensions are nominal

| Device       | Package Type | Package Drawing | Pins | SPQ  | Length (mm) | Width (mm) | Height (mm) |
|--------------|--------------|-----------------|------|------|-------------|------------|-------------|
| DAC7624U/1K  | SOIC         | DW              | 28   | 1000 | 350.0       | 350.0      | 66.0        |
| DAC7624UB/1K | SOIC         | DW              | 28   | 1000 | 350.0       | 350.0      | 66.0        |
| DAC7625U/1K  | SOIC         | DW              | 28   | 1000 | 350.0       | 350.0      | 66.0        |
| DAC7625UB/1K | SOIC         | DW              | 28   | 1000 | 350.0       | 350.0      | 66.0        |

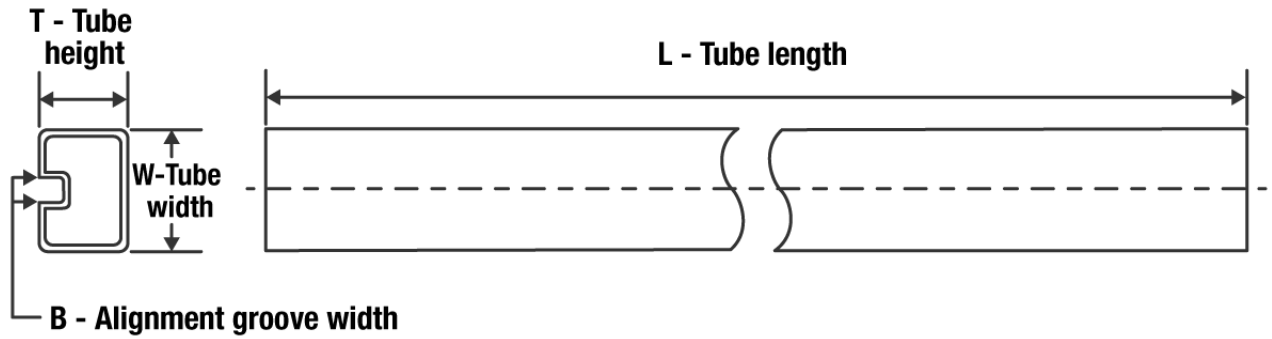
**TUBE**

\*All dimensions are nominal

| Device    | Package Name | Package Type | Pins | SPQ | L (mm) | W (mm) | T (μm) | B (mm) |
|-----------|--------------|--------------|------|-----|--------|--------|--------|--------|
| DAC7624U  | DW           | SOIC         | 28   | 20  | 506.98 | 12.7   | 4826   | 6.6    |
| DAC7624UB | DW           | SOIC         | 28   | 20  | 506.98 | 12.7   | 4826   | 6.6    |
| DAC7625U  | DW           | SOIC         | 28   | 20  | 506.98 | 12.7   | 4826   | 6.6    |
| DAC7625UB | DW           | SOIC         | 28   | 20  | 506.98 | 12.7   | 4826   | 6.6    |

## IMPORTANT NOTICE AND DISCLAIMER

TI PROVIDES TECHNICAL AND RELIABILITY DATA (INCLUDING DATA SHEETS), DESIGN RESOURCES (INCLUDING REFERENCE DESIGNS), APPLICATION OR OTHER DESIGN ADVICE, WEB TOOLS, SAFETY INFORMATION, AND OTHER RESOURCES "AS IS" AND WITH ALL FAULTS, AND DISCLAIMS ALL WARRANTIES, EXPRESS AND IMPLIED, INCLUDING WITHOUT LIMITATION ANY IMPLIED WARRANTIES OF MERCHANTABILITY, FITNESS FOR A PARTICULAR PURPOSE OR NON-INFRINGEMENT OF THIRD PARTY INTELLECTUAL PROPERTY RIGHTS.

These resources are intended for skilled developers designing with TI products. You are solely responsible for (1) selecting the appropriate TI products for your application, (2) designing, validating and testing your application, and (3) ensuring your application meets applicable standards, and any other safety, security, regulatory or other requirements.

These resources are subject to change without notice. TI grants you permission to use these resources only for development of an application that uses the TI products described in the resource. Other reproduction and display of these resources is prohibited. No license is granted to any other TI intellectual property right or to any third party intellectual property right. TI disclaims responsibility for, and you will fully indemnify TI and its representatives against, any claims, damages, costs, losses, and liabilities arising out of your use of these resources.

TI's products are provided subject to [TI's Terms of Sale](#) or other applicable terms available either on [ti.com](http://ti.com) or provided in conjunction with such TI products. TI's provision of these resources does not expand or otherwise alter TI's applicable warranties or warranty disclaimers for TI products.

TI objects to and rejects any additional or different terms you may have proposed.

Mailing Address: Texas Instruments, Post Office Box 655303, Dallas, Texas 75265  
Copyright © 2022, Texas Instruments Incorporated