

## 24-V 输入电压, 150-mA, 超低 $I_Q$ 低压差稳压器

### 特性

- 宽输入电压范围: **2.5 V 至 24 V**
- 低 **3.2- $\mu$ A** 静态电流
- 接地引脚电流: 在  $I_{OUT}$  为 **100-mA** 时为 **3.4  $\mu$ A**
- 与任何电容器 (> **0.47  $\mu$ F**)
- 采用 **SOT23-5** 封装
- 工作结点温度范围:  
**-40°C 至 +125°C**

### 应用

- 超低功耗微处理器
- 电子仪表
- 火警/烟感系统
- 手持式外设
- 工业/汽车应用
- 远程控制器
- **Zigbee™** 网络
- **PDA**
- 便携式、电池供电型仪器

### 说明

TLV701xx 系列低压差 (LDO) 稳压器是超低静态电流设备, 设计用于极度电源敏感的应用。在完全负载电流和周围环境温度范围内, 静态电流保持恒定。这些设备都是低功率微控制器理想的电源管理附件, 例如 **MSP430**。

TLV701xx 运行在 2.5 V 至 24 V 输入电压范围内。因此, 对于电池供电系统和产生大量线路瞬变的工业应用来说, 此款设备都是不错的选择。

TLV701xx 采用 3-mm  $\times$  3-mm SOT23-5 封装, 此种封装非常适合高成本有效性的主板制造。

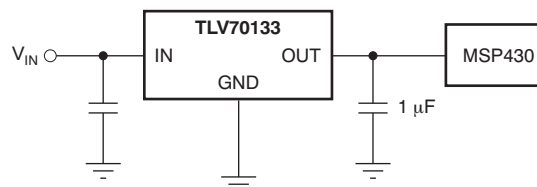
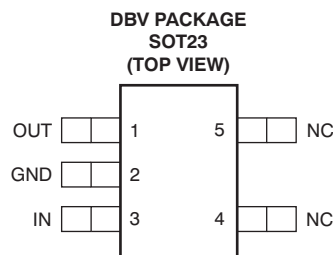

Please be aware that an important notice concerning availability, standard warranty, and use in critical applications of Texas Instruments semiconductor products and disclaimers thereto appears at the end of this data sheet.

Zigbee is a trademark of ZigBee Alliance.

All other trademarks are the property of their respective owners.



This integrated circuit can be damaged by ESD. Texas Instruments recommends that all integrated circuits be handled with appropriate precautions. Failure to observe proper handling and installation procedures can cause damage.

ESD damage can range from subtle performance degradation to complete device failure. Precision integrated circuits may be more susceptible to damage because very small parametric changes could cause the device not to meet its published specifications.

### AVAILABLE OPTIONS<sup>(1)</sup>

PRODUCT	V <sub>OUT</sub>
TLV701xxyyyz	<b>XX</b> is nominal output voltage (for example, 30 = 3.0 V) <b>YYY</b> is Package Designator <b>Z</b> is Package Quantity

- (1) For the most current package and ordering information, see the Package Option Addendum at the end of this document, or visit the device product folder at [www.ti.com](http://www.ti.com).

### ABSOLUTE MAXIMUM RATINGS<sup>(1)</sup>

Over operating free-air temperature range, unless otherwise noted.

		VALUE		UNIT
		MIN	MAX	
Voltage <sup>(2)</sup>	IN	-0.3	24	V
Current source	OUT	Internally limited		
Temperature	Operating junction, T <sub>J</sub>	-40	+150	°C
	Storage, T <sub>stg</sub>	-65	+150	°C
Electrostatic Discharge Rating <sup>(3)</sup>	Human body model (HBM) QSS 009-105 (JESD22-A114A)		2	kV
	Charged device model (CDM) QSS 009-147 (JESD22-C101B.01)		500	V

- (1) Stresses beyond those listed under *absolute maximum ratings* may cause permanent damage to the device. These are stress ratings only, and functional operation of the device at these or any other conditions beyond those indicated under *recommended operating conditions* is not implied. Exposure to absolute-maximum-rated conditions for extended periods may affect device reliability.
- (2) All voltages are with respect to network ground terminal.
- (3) ESD testing is performed according to the respective JESD22 JEDEC standard.

### THERMAL INFORMATION

THERMAL METRIC <sup>(1)</sup>		TLV701XX	UNITS
		DBV	
		5 PINS	
θ <sub>JA</sub>	Junction-to-ambient thermal resistance	213.1	°C/W
θ <sub>JCtop</sub>	Junction-to-case (top) thermal resistance	110.9	
θ <sub>JB</sub>	Junction-to-board thermal resistance	97.4	
ψ <sub>JT</sub>	Junction-to-top characterization parameter	22.0	
ψ <sub>JB</sub>	Junction-to-board characterization parameter	78.4	
θ <sub>JCbot</sub>	Junction-to-case (bottom) thermal resistance	n/a	

- (1) 有关传统和新的热度的更多信息，请参阅 IC 封装热量应用报告 [SPRA953](http://www.ti.com)。

**ELECTRICAL CHARACTERISTICS:  $T_A = +25^\circ\text{C}$**

All values are at  $T_A = +25^\circ\text{C}$ ,  $V_{IN} = V_{OUT(nom)} + 1\text{ V}$ ,  $I_{OUT} = 1\text{ mA}$ , and  $C_{OUT} = 1\text{ }\mu\text{F}$ , unless otherwise noted.

PARAMETER	TEST CONDITIONS	TLV701xx			UNIT	
		MIN	TYP	MAX		
$V_O$	Input voltage range			24	V	
	Output voltage range	1.2		5	V	
$V_{OUT}$	DC output accuracy	-2		2	%	
$\Delta V_O$ for $\Delta V_{IN}$	Line regulation	$V_{OUT(NOM)} + 1\text{ V} < V_{IN} < 24\text{ V}$		20	50	mV
$\Delta V_O$ for $\Delta I_{OUT}$	Load regulation	$1\text{ mA} < I_{OUT} < 10\text{ mA}$		6		mV
		$1\text{ mA} < I_{OUT} < 50\text{ mA}$		19		mV
		$1\text{ mA} < I_{OUT} < 100\text{ mA}$		29	50	mV
$V_{DO}$	Dropout voltage <sup>(1)</sup>	$I_{OUT} = 10\text{ mA}$		75		mV
		$I_{OUT} = 50\text{ mA}$		400		mV
$I_{CL}$	Output current limit	$V_{OUT} = 0\text{ V}$		160	1000	mA
$I_{GND}$	Ground pin current	$I_{OUT} = 0\text{ mA}$		3.2	4.5	$\mu\text{A}$
		$I_{OUT} = 100\text{ mA}$		3.4	5.5	$\mu\text{A}$
PSRR	Power-supply rejection ratio	$f = 100\text{ kHz}$ , $C_{OUT} = 10\text{ }\mu\text{F}$		60		dB

(1)  $V_{IN} = V_{OUT(NOM)} - 0.1\text{ V}$ .

**FUNCTIONAL BLOCK DIAGRAM**

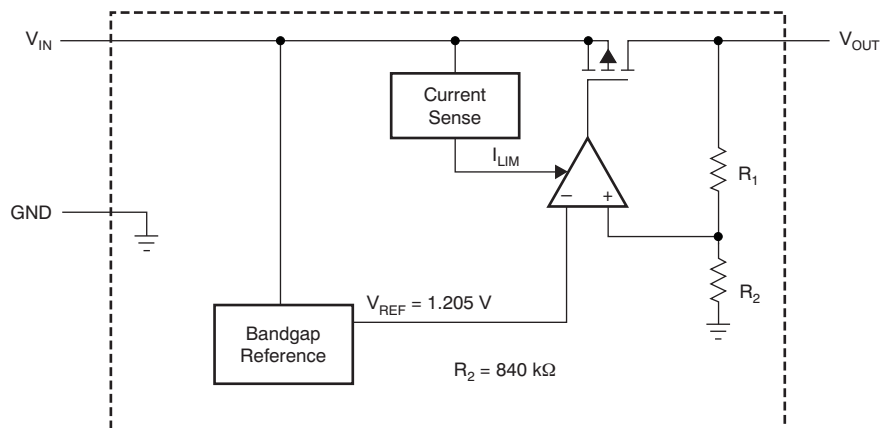

## PIN CONFIGURATIONS

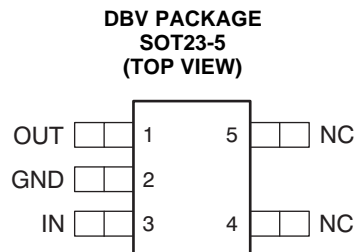

**Table 1. Pin Descriptions**

TLV701xx		DESCRIPTION
NAME	DBV	
GND	2	Ground
IN	3	Unregulated input voltage.
OUT	1	Regulated output voltage. Any capacitor 1 $\mu$ F or greater between this pin and ground is needed for stability.
NC	4, 5	No connection. This pin can be left open or tied to ground for improved thermal performance.

TYPICAL CHARACTERISTICS

LINE REGULATION

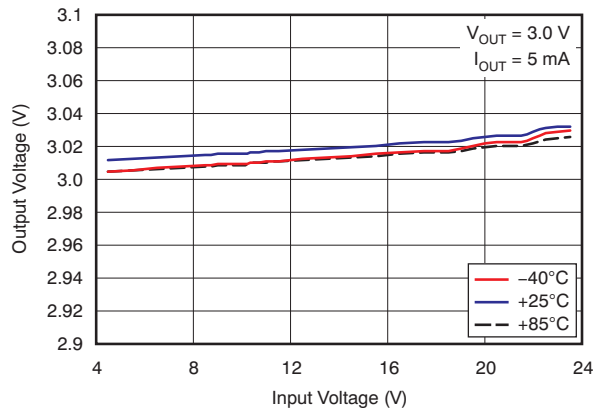

Figure 1.

LOAD REGULATION  
( $V_{OUT} = 3.0\text{ V}$ )

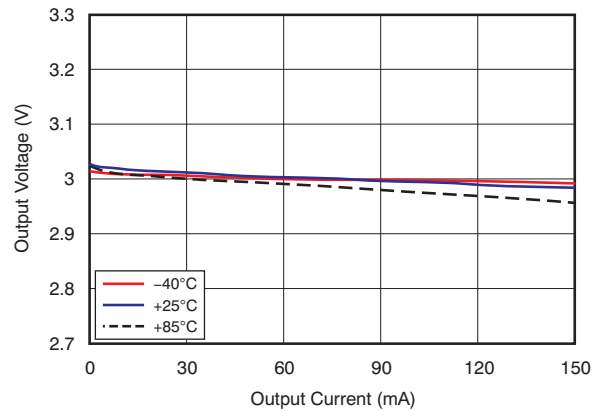

Figure 2.

OUTPUT VOLTAGE vs  
JUNCTION TEMPERATURE

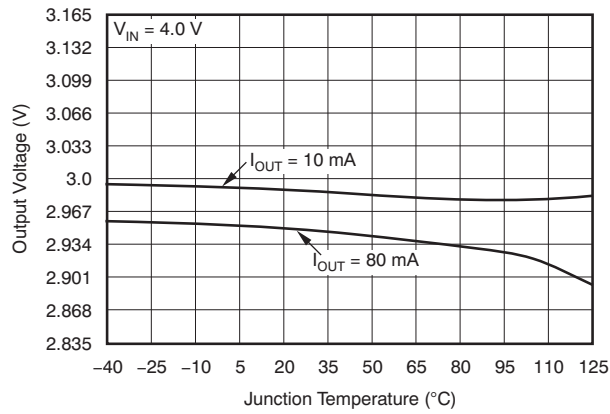

Figure 3.

DROPOUT VOLTAGE vs INPUT VOLTAGE

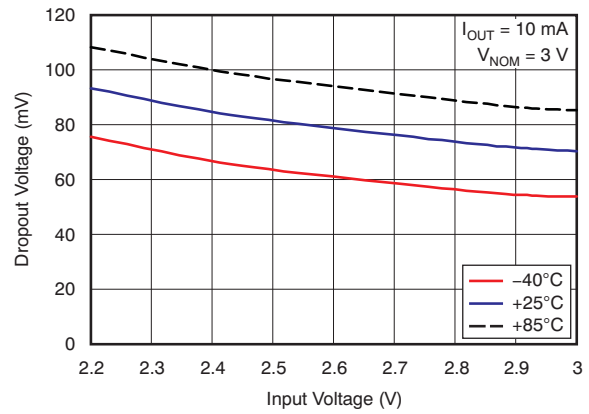

Figure 4.

DROPOUT VOLTAGE vs OUTPUT CURRENT

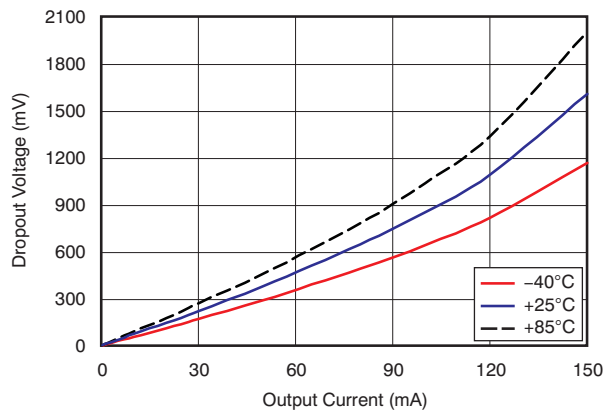

Figure 5.

GROUND CURRENT vs JUNCTION TEMPERATURE

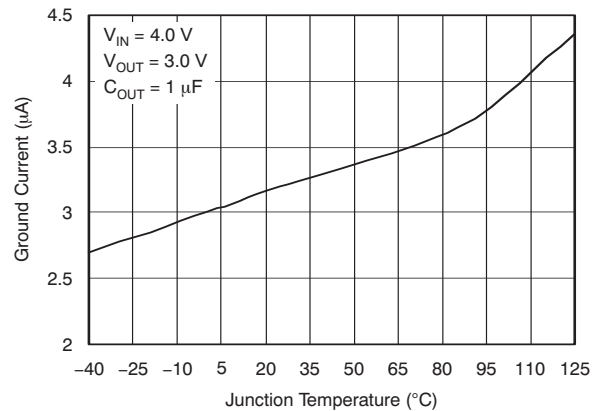

Figure 6.

PRODUCT PREVIEW

**TYPICAL CHARACTERISTICS (continued)**

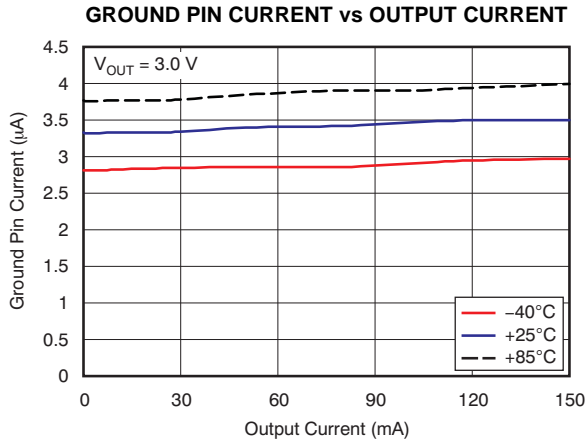

Figure 7.

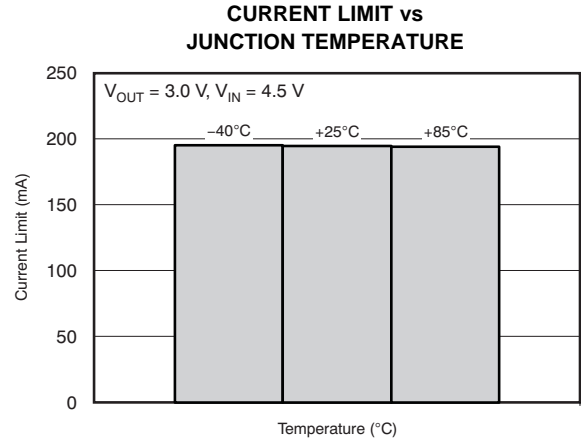

Figure 8.

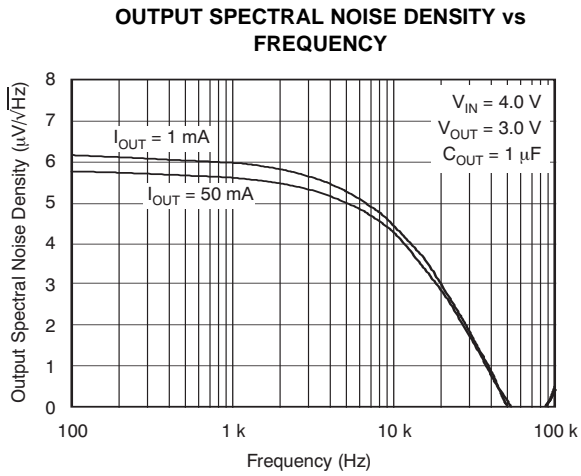

Figure 9.

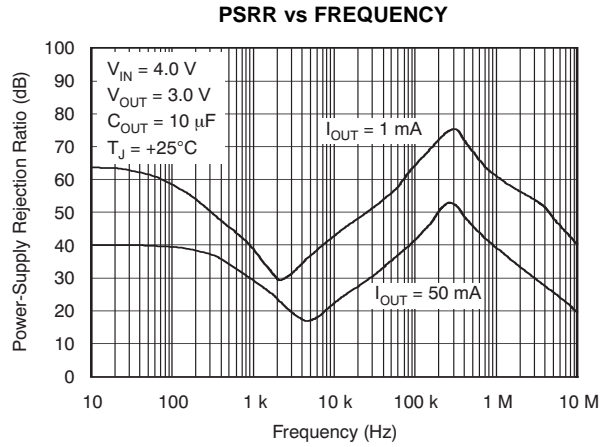

Figure 10.

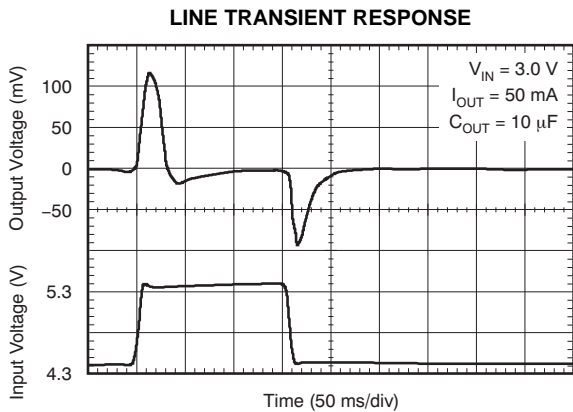

Figure 11.

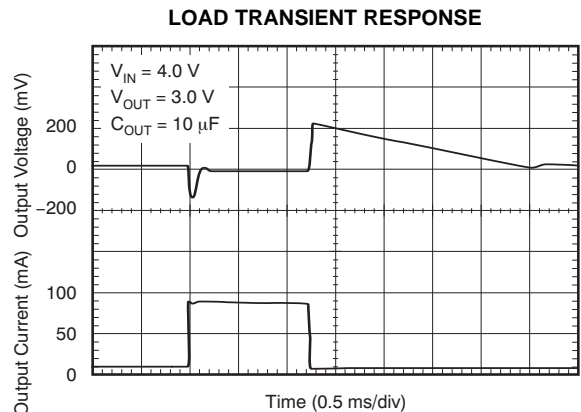

Figure 12.

PRODUCT PREVIEW

## APPLICATION INFORMATION

The TLV701xx series of devices belong to a family of ultralow,  $I_Q$ , low-dropout (LDO) regulators.  $I_Q$  remains fairly constant over the complete output load current and temperature range. The devices are ensured to operate over a temperature range of  $-40^{\circ}\text{C}$  to  $+125^{\circ}\text{C}$ .

### INPUT AND OUTPUT CAPACITOR REQUIREMENTS

The TLV701 requires a 1- $\mu\text{F}$  or larger capacitor connected between OUT and GND for stability. Ceramic or tantalum capacitors can be used. Larger value capacitors result in better transient and noise performance.

Although an input capacitor is not required for stability, when a 0.1- $\mu\text{F}$  or larger capacitor is placed between IN and GND, it counteracts reactive input sources and improves transient and noise performance. Higher value capacitors are necessary if large, fast rise time load transients are anticipated.

### BOARD LAYOUT RECOMMENDATIONS

Input and output capacitors should be placed as close to the device pins as possible. To avoid interference of noise and ripple on the board, it is recommended that the board be designed with separate ground planes for  $V_{\text{IN}}$  and  $V_{\text{OUT}}$ , with the ground plane connected only at the device GND pin. In addition, the ground connection for the output capacitor should be connected directly to the device GND pin.

### POWER DISSIPATION AND JUNCTION TEMPERATURE

To ensure reliable operation, worst-case junction temperature should not exceed  $+125^{\circ}\text{C}$ . This restriction limits the power dissipation the regulator can handle in any given application. To ensure the junction temperature is within acceptable limits, calculate the maximum allowable dissipation,  $P_{D(\text{max})}$ , and the actual dissipation,  $P_D$ , which must be less than or equal to  $P_{D(\text{max})}$ .

The maximum power dissipation limit is determined using [Equation 1](#):

$$P_{D(\text{max})} = \frac{T_{J\text{max}} - T_A}{R_{\theta\text{JA}}} \quad (1)$$

where:

$T_{J\text{max}}$  is the maximum allowable junction temperature.

$R_{\theta\text{JA}}$  is the thermal resistance junction-to-ambient for the package.

$T_A$  is the ambient temperature.

The regulator dissipation is calculated using [Equation 2](#):

$$P_D = (V_{\text{IN}} - V_{\text{OUT}}) \times I_{\text{OUT}} \quad (2)$$

Power dissipation that results from quiescent current is negligible.

### REGULATOR PROTECTION

The TLV701xx series of LDO regulators use a PMOS-pass transistor that has a built-in back diode that conducts reverse current when the input voltage drops below the output voltage (for example, during power-down). Current is conducted from the output to the input and is not internally limited. If extended reverse voltage operation is anticipated, external limiting might be appropriate.

The TLV701xx features internal current limiting. During normal operation, the TLV701xx limits output current to approximately 250 mA. When current limiting engages, the output voltage scales back linearly until the overcurrent condition ends. Take care not to exceed the rated maximum operating junction temperature of  $+125^{\circ}\text{C}$ . Continuously running the device under conditions where the junction temperature exceeds  $+125^{\circ}\text{C}$  degrades device reliability.

The ability to remove heat from the die is different for each package type, presenting different considerations in the printed circuit board (PCB) layout. The PCB area around the device that is free of other components moves the heat from the device to the ambient air. Using heavier copper increases the effectiveness in removing heat from the device. The addition of plated through-holes to heat-dissipating layers also improves heatsink effectiveness. Power dissipation depends on input voltage and load conditions. Power dissipation ( $P_D$ ) is equal to the product of the output current and the voltage drop across the output pass element, as shown in [Equation 2](#).

**PACKAGING INFORMATION**

Orderable Device	Status (1)	Package Type	Package Drawing	Pins	Package Qty	Eco Plan (2)	Lead finish/ Ball material (6)	MSL Peak Temp (3)	Op Temp (°C)	Device Marking (4/5)	Samples
TLV70130DBVR	ACTIVE	SOT-23	DBV	5	3000	RoHS & Green	NIPDAU	Level-1-260C-UNLIM	-40 to 125	YBVA	<a href="#">Samples</a>
TLV70130DBVT	ACTIVE	SOT-23	DBV	5	250	RoHS & Green	NIPDAU	Level-1-260C-UNLIM	-40 to 125	YBVA	<a href="#">Samples</a>
TLV70133DBVR	ACTIVE	SOT-23	DBV	5	3000	RoHS & Green	NIPDAU	Level-1-260C-UNLIM	-40 to 125	YBWA	<a href="#">Samples</a>
TLV70133DBVT	ACTIVE	SOT-23	DBV	5	250	RoHS & Green	NIPDAU	Level-1-260C-UNLIM	-40 to 125	YBWA	<a href="#">Samples</a>

(1) The marketing status values are defined as follows:

**ACTIVE:** Product device recommended for new designs.

**LIFEBUY:** TI has announced that the device will be discontinued, and a lifetime-buy period is in effect.

**NRND:** Not recommended for new designs. Device is in production to support existing customers, but TI does not recommend using this part in a new design.

**PREVIEW:** Device has been announced but is not in production. Samples may or may not be available.

**OBSELETE:** TI has discontinued the production of the device.

(2) **RoHS:** TI defines "RoHS" to mean semiconductor products that are compliant with the current EU RoHS requirements for all 10 RoHS substances, including the requirement that RoHS substance do not exceed 0.1% by weight in homogeneous materials. Where designed to be soldered at high temperatures, "RoHS" products are suitable for use in specified lead-free processes. TI may reference these types of products as "Pb-Free".

**RoHS Exempt:** TI defines "RoHS Exempt" to mean products that contain lead but are compliant with EU RoHS pursuant to a specific EU RoHS exemption.

**Green:** TI defines "Green" to mean the content of Chlorine (Cl) and Bromine (Br) based flame retardants meet JS709B low halogen requirements of <=1000ppm threshold. Antimony trioxide based flame retardants must also meet the <=1000ppm threshold requirement.

(3) **MSL, Peak Temp.** - The Moisture Sensitivity Level rating according to the JEDEC industry standard classifications, and peak solder temperature.

(4) There may be additional marking, which relates to the logo, the lot trace code information, or the environmental category on the device.

(5) Multiple Device Markings will be inside parentheses. Only one Device Marking contained in parentheses and separated by a "-" will appear on a device. If a line is indented then it is a continuation of the previous line and the two combined represent the entire Device Marking for that device.

(6) **Lead finish/Ball material** - Orderable Devices may have multiple material finish options. Finish options are separated by a vertical ruled line. Lead finish/Ball material values may wrap to two lines if the finish value exceeds the maximum column width.

**Important Information and Disclaimer:**The information provided on this page represents TI's knowledge and belief as of the date that it is provided. TI bases its knowledge and belief on information provided by third parties, and makes no representation or warranty as to the accuracy of such information. Efforts are underway to better integrate information from third parties. TI has taken and

continues to take reasonable steps to provide representative and accurate information but may not have conducted destructive testing or chemical analysis on incoming materials and chemicals. TI and TI suppliers consider certain information to be proprietary, and thus CAS numbers and other limited information may not be available for release.

In no event shall TI's liability arising out of such information exceed the total purchase price of the TI part(s) at issue in this document sold by TI to Customer on an annual basis.



# EXAMPLE BOARD LAYOUT

DBV0005A

SOT-23 - 1.45 mm max height

SMALL OUTLINE TRANSISTOR

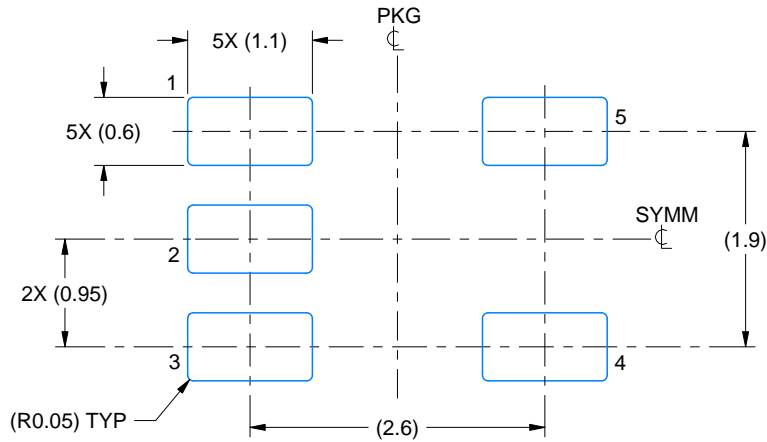

LAND PATTERN EXAMPLE  
EXPOSED METAL SHOWN  
SCALE:15X

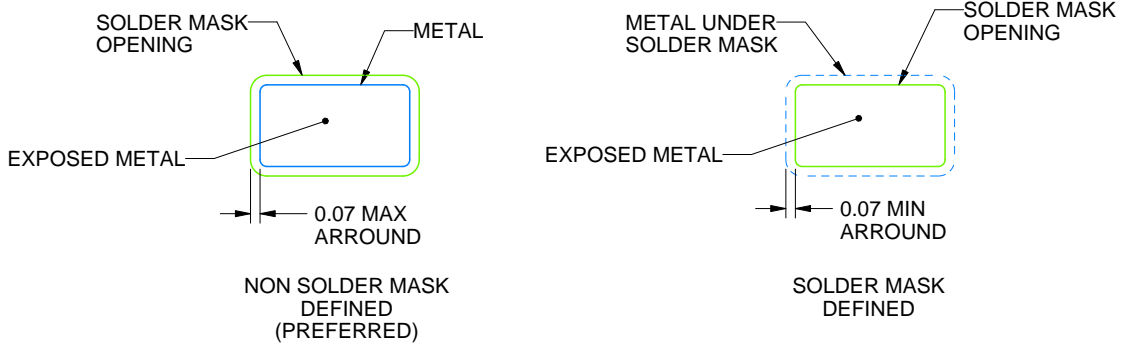

SOLDER MASK DETAILS

4214839/F 06/2021

NOTES: (continued)

- 5. Publication IPC-7351 may have alternate designs.
- 6. Solder mask tolerances between and around signal pads can vary based on board fabrication site.

# EXAMPLE STENCIL DESIGN

DBV0005A

SOT-23 - 1.45 mm max height

SMALL OUTLINE TRANSISTOR

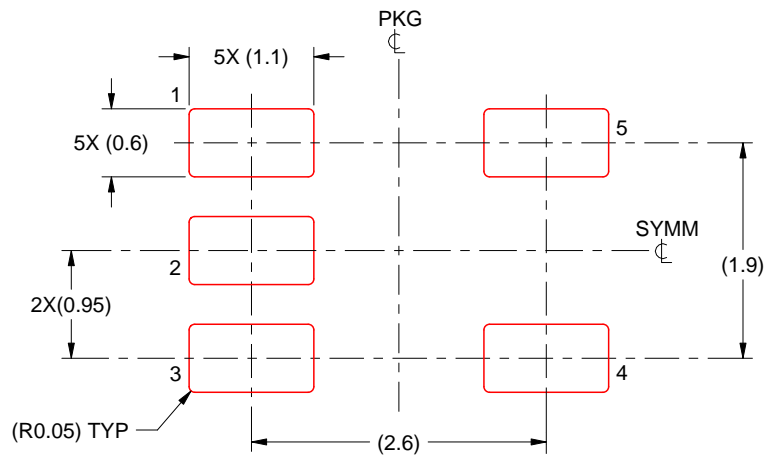

SOLDER PASTE EXAMPLE  
BASED ON 0.125 mm THICK STENCIL  
SCALE:15X

4214839/F 06/2021

NOTES: (continued)

7. Laser cutting apertures with trapezoidal walls and rounded corners may offer better paste release. IPC-7525 may have alternate design recommendations.
8. Board assembly site may have different recommendations for stencil design.

## 重要声明和免责声明

TI“按原样”提供技术和可靠性数据（包括数据表）、设计资源（包括参考设计）、应用或其他设计建议、网络工具、安全信息和其他资源，不保证没有瑕疵且不做任何明示或暗示的担保，包括但不限于对适销性、某特定用途方面的适用性或不侵犯任何第三方知识产权的暗示担保。

这些资源可供使用 TI 产品进行设计的熟练开发人员使用。您将自行承担以下全部责任：(1) 针对您的应用选择合适的 TI 产品，(2) 设计、验证并测试您的应用，(3) 确保您的应用满足相应标准以及任何其他功能安全、信息安全、监管或其他要求。

这些资源如有变更，恕不另行通知。TI 授权您仅可将这些资源用于研发本资源所述的 TI 产品的应用。严禁对这些资源进行其他复制或展示。您无权使用任何其他 TI 知识产权或任何第三方知识产权。您应全额赔偿因在这些资源的使用中对 TI 及其代表造成的任何索赔、损害、成本、损失和债务，TI 对此概不负责。

TI 提供的产品受 [TI 的销售条款](#) 或 [ti.com](#) 上其他适用条款/TI 产品随附的其他适用条款的约束。TI 提供这些资源并不会扩展或以其他方式更改 TI 针对 TI 产品发布的适用的担保或担保免责声明。

TI 反对并拒绝您可能提出的任何其他或不同的条款。

邮寄地址：Texas Instruments, Post Office Box 655303, Dallas, Texas 75265  
Copyright © 2021，德州仪器 (TI) 公司