

## LM49251 Boomer® Audio Power Amplifier Series **Stereo Audio Subsystem with Class G Headphone Amplifier and Class D Speaker Amplifier with Speaker Protection**

Check for Samples: [LM49251](#)

### FEATURES

- **Class G Ground Referenced Headphone Outputs**
- **E<sup>2</sup>S Class D Amplifier**
- **No Clip Function**
- **Power Limiter Speaker Protection**
- **I<sup>2</sup>C Volume and Mode Control**
- **Advanced Click-and-Pop Suppression**
- **Micro-Power Shutdown**

### APPLICATIONS

- **Feature Phones**
- **Smart Phones**

### KEY SPECIFICATIONS

- **Class G Headphone Amplifier,  $HPV_{DD} = 1.8V$ ,  $R_L = 32\Omega$** 
  - **IDDQ<sub>HP</sub>: 1.15 mA (Typ)**
  - **Output Power, THD+N ≤ 1%: 20 mW (Typ)**
- **Stereo Class D Speaker Amplifier  $R_L = 8\Omega$** 
  - **Output Power, THD+N ≤ 1%,  $LSV_{DD} = 5.0V$ : 1.37 W (Typ)**
  - **Output Power, THD+N ≤ 1%,  $LSV_{DD} = 3.6V$ : 680 mW (Typ)**
  - **Efficiency: 90% (Typ)**

### DESCRIPTION

The LM49251 is a fully integrated audio subsystem designed for portable handheld applications such as cellular phones. Part of TI's PowerWise family of products, the LM49251 utilizes a high efficiency class G headphone amplifier topology as well as a high efficiency class D loudspeaker.

The headphone amplifiers feature TI's class G ground referenced architecture that creates a ground-referenced output with dynamic supply rails for optimum efficiency. The stereo class D speaker amplifier provides both a no-clip feature and speaker protection. The Enhanced Emission Suppression (E<sup>2</sup>S) outputs feature a patented, ultra low EMI PWM architecture that significantly reduces RF emissions.

The LM49251 features separate volume controls for the mono and stereo inputs. Mode selection, shutdown control, and volume are controlled through an I<sup>2</sup>C compatible interface.

Click and pop suppression eliminates audible transients on power-up/down and during shutdown. The LM49251 is available in an ultra-small 30-bump DSBGA package (2.55mmx3.02mm)



Please be aware that an important notice concerning availability, standard warranty, and use in critical applications of Texas Instruments semiconductor products and disclaimers thereto appears at the end of this data sheet.

All trademarks are the property of their respective owners.

**Simplified Block Diagram**

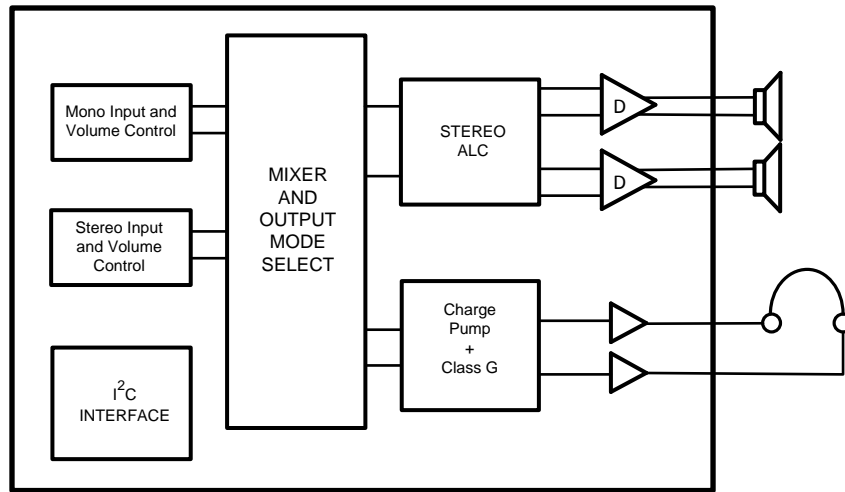

**Figure 1. LM49251 Simplified Block Diagram**

Typical Application

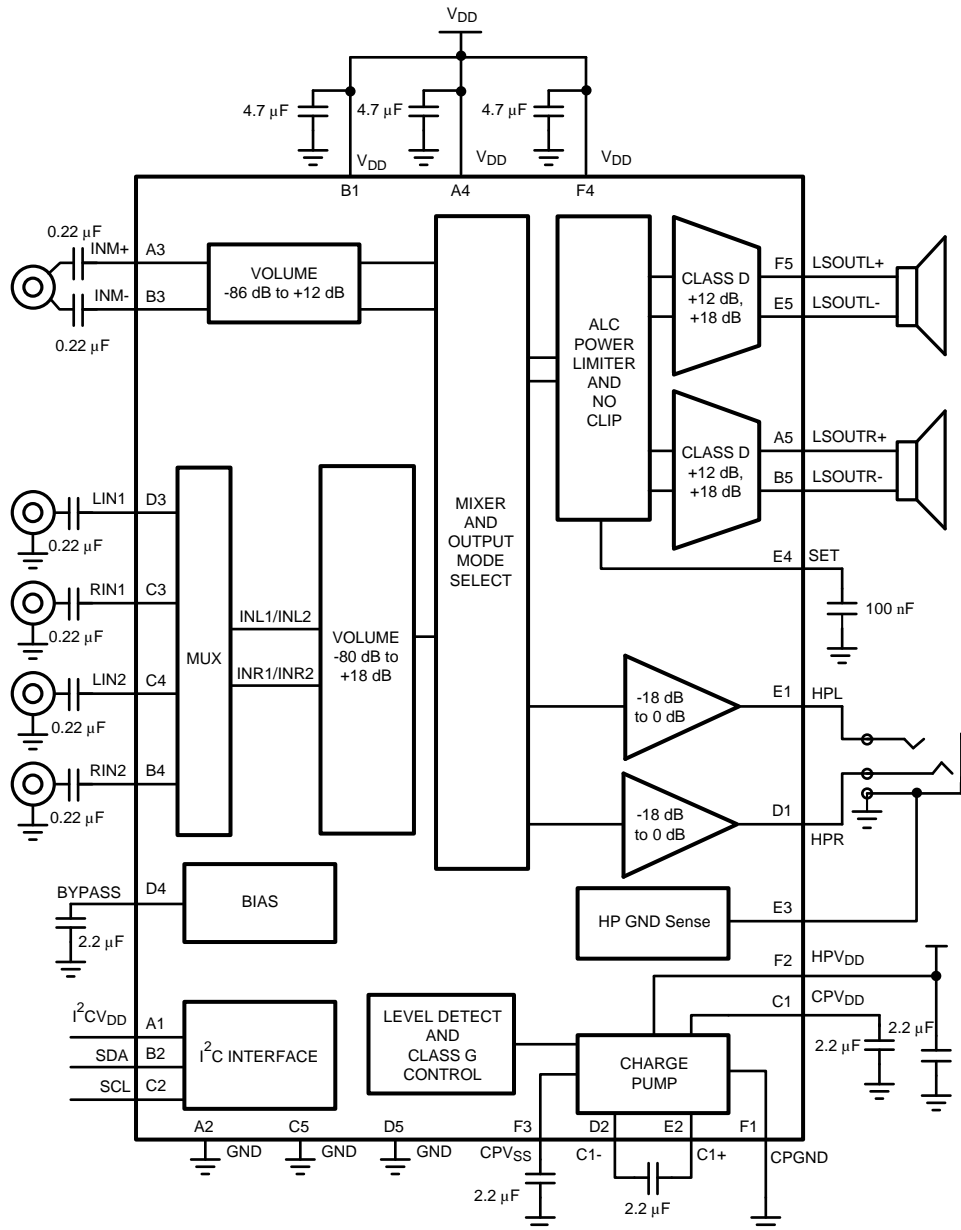
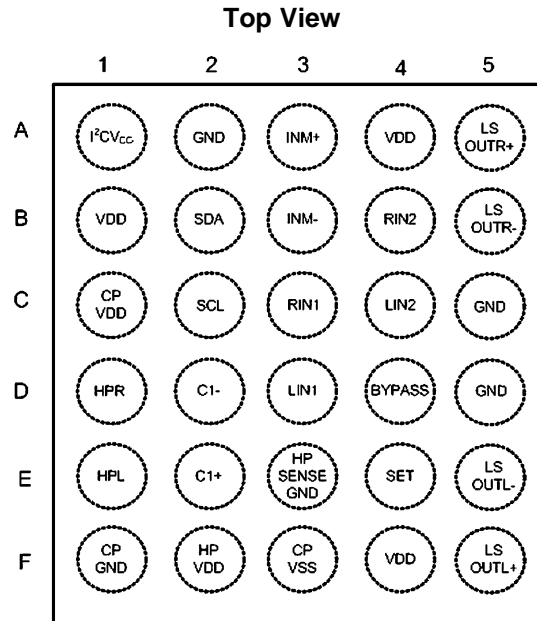

Figure 2. Typical Audio Amplifier Application Circuit

## Connection Diagram



**Figure 3. DSBGA Package**  
See Package Number YZR0030

**Table 1. Bump Description**

Bump	Name	Description
A1	ⓘ <sup>2</sup> CV <sub>DD</sub>	ⓘ <sup>2</sup> C Power Supply
A2	GND	Ground
A3	INM+	Mono Channel Non-Inverting Input
A4	V <sub>DD</sub>	Loudspeaker Power Supply
A5	LSOUTR+	Right Loudspeaker Non-Inverting Output
B1	V <sub>DD</sub>	Loudspeaker Power Supply
B2	SDA	ⓘ <sup>2</sup> C Serial Data Input
B3	INM-	Mono Channel Inverting Input
B4	RIN2	Right Channel Input 2
B5	LSOUTR-	Right Loudspeaker Inverting Output
C1	CPV <sub>DD</sub>	Charge Pump Supply (internally generated)
C2	SCL	ⓘ <sup>2</sup> C Serial Clock Input
C3	RIN1	Right Channel Input 1
C4	LIN2	Left Channel Input 2
C5	GND	Ground
D1	HPR	Right Channel Headphone Output
D2	C1-	Charge Pump Flying Capacitor Negative Terminal
D3	LIN1	Left Channel Input 1
D4	BYPASS	Mid-Rail Bias Bypass Node
D5	GND	Ground
E1	HPL	Left Channel Headphone Output
E2	C1+	Charge Pump Flying Capacitor Positive Terminal
E3	HP SENSE GND	Headphone Ground Sense
E4	SET	ALC Timing Set

**Table 1. Bump Description (continued)**

Bump	Name	Description
E5	LSOUTL-	Left Loudspeaker Inverting Output
F1	CPGND	Charge Pump Ground
F2	HPV <sub>DD</sub>	Headphone Power Supply
F3	CPV <sub>SS</sub>	Charge Pump Output
F4	V <sub>DD</sub>	Loudspeaker Power Supply
F5	LSOUTL+	Left Loudspeaker Non-Inverting Output



These devices have limited built-in ESD protection. The leads should be shorted together or the device placed in conductive foam during storage or handling to prevent electrostatic damage to the MOS gates.

**Absolute Maximum Ratings**<sup>(1)(2)(3)</sup>

Supply Voltage <sup>(1)</sup>	V <sub>DD</sub> , I <sup>2</sup> CV <sub>DD</sub>	6V
	HPV <sub>DD</sub>	3V
Storage Temperature		-65°C to +150°C
Input Voltage		-0.3V to V <sub>DD</sub> +0.3V
Power Dissipation <sup>(4)</sup>		Internally Limited
ESD HBM <sup>(5)</sup>		2000V
ESD MM <sup>(6)</sup>		150V
ESD CDM <sup>(7)</sup>		750V
Junction Temperature		150°C
Thermal Resistance	θ <sub>JA</sub> (TLA30B1A)	90°C/W
Soldering Information: See AN-1112 (Literature Number <a href="#">SNVA009</a> )		

- (1) Absolute Maximum Ratings indicate limits beyond which damage to the device may occur, including inoperability and degradation of device reliability and/or performance. Functional operation of the device and/or non-degradation at the Absolute Maximum Ratings or other conditions beyond those indicated in the Recommended Operating Conditions is not implied. The Recommended Operating Conditions indicate conditions at which the device is functional and the device should not be operated beyond such conditions. All voltages are measured with respect to the ground pin, unless otherwise specified.
- (2) The Electrical Characteristics tables list specified specifications under the listed Recommended Operating Conditions except as otherwise modified or specified by the Electrical Characteristics Conditions and/or Notes. Typical specifications are estimations only and are not ensured.
- (3) If Military/Aerospace specified devices are required, please contact the Texas Instruments Sales Office/Distributors for availability and specifications.
- (4) The maximum power dissipation must be derated at elevated temperatures and is dictated by T<sub>JMAX</sub>, θ<sub>JA</sub>, and the ambient temperature, T<sub>A</sub>. The maximum allowable power dissipation is P<sub>DMAX</sub> = (T<sub>JMAX</sub> - T<sub>A</sub>) / θ<sub>JA</sub> or the number given in *Absolute Maximum Ratings*, whichever is lower.
- (5) Human body model, applicable std. JESD22-A114C.
- (6) Machine model, applicable std. JESD22-A115-A.
- (7) Charge device model, applicable std. JESD22-C101D.

**Operating Ratings**

Temperature Range (T <sub>MIN</sub> ≤ T <sub>A</sub> ≤ T <sub>MAX</sub> )		-40°C ≤ T <sub>A</sub> ≤ +85°C
Supply Voltage	V <sub>DD</sub>	2.7V ≤ V <sub>DD</sub> ≤ 5.5V
	HPV <sub>DD</sub>	1.6V ≤ HPV <sub>DD</sub> ≤ 2.0V
	I <sup>2</sup> C <sub>DD</sub>	1.7V ≤ I <sup>2</sup> CV <sub>DD</sub> ≤ 5.5V

### Electrical Characteristics<sup>(1)(2)(3)</sup>

The following specifications apply for  $A_V = 0\text{dB}$ ,  $R_L = 15\mu\text{H} + 8\Omega + 15\mu\text{H}$  (Loudspeaker),  $R_L = 32\Omega$  (Headphone),  $C_{\text{SET}} = 100\text{nF}$ ,  $f = 1\text{kHz}$ , ALC off, unless otherwise specified. Limits apply for  $T_A = 25^\circ\text{C}$ .

Parameter		Test Conditions	LM49251		Units (Limits)
			Typ <sup>(4)</sup>	Limit <sup>(5)</sup>	
$I_{\text{DD}}$	Quiescent Power Supply Current ( $LSV_{\text{DD}} + V_{\text{DD}}$ )	$V_{\text{IN}} = 0$ , No Load			
		LS Mode (stereo input), mode 2	5.6	6.25	mA (max)
		LS Mode (mono input), mode 3	5.3	6.0	mA (max)
		HP Mode (stereo input), mode 6	2.1	2.4	mA (max)
		HP Mode (mono input), mode 4	1.8	2.0	mA (max)
		LS+HP Mode (stereo input), mode 8	6.1	6.8	mA (max)
		LS+HP Mode (mono input), mode 5	5.8	6.5	mA (max)
		LS Mode (stereo input, ALC on), mode 2	5.9		
$I_{\text{DD(HP)}}$	Quiescent Power Supply Current ( $HPV_{\text{DD}}$ )	$V_{\text{IN}} = 0$ , No Load, Mode 6	1.15	1.45	mA (max)
	Operating Power Supply Current ( $HPV_{\text{DD}}$ )	$P_{\text{OUT}} = 0.5\text{mW}$ , $GAMP_{\text{SD}} = 0$ , $R_L = 32\Omega$ , Mode 6	4.3	4.6	mA (max)
		$P_{\text{OUT}} = 1\text{mW}$ , $GAMP_{\text{SD}} = 0$ , $R_L = 32\Omega$ , Mode 6	5.8	6.15	mA (max)
$I_{\text{SD}}$	Shutdown Current		0.02	1	$\mu\text{A}$ (max)
$V_{\text{OS}}$	Output Offset Voltage	$V_{\text{IN}} = 0$			
		Mode 3, mono input, $A_V = 6\text{dB}$	12		mV (max)
		Mode 4, mono input	1.1		mV (max)
		Mode 2, stereo input, $A_V = 6\text{dB}$	12		mV (max)
		Mode 6, stereo input	1.1		mV (max)
$T_{\text{WU}}$	Wake Up Time	HP mode, $C_{\text{BYPASS}} = 2.2\mu\text{F}$			
		Normal turn on time	31		ms
		Fast turn on time	16		ms
$A_{\text{VOL}}$	Volume Control	Minimum Gain Setting (mono input), Mode 3	-86		dB (max) dB (min)
		Maximum Gain Setting (mono input), Mode 3	12	13 11.5	dB (max) dB (min)
		Minimum Gain Setting (stereo input), Mode 6	-80		dB (max) dB (min)
		Maximum Gain Setting (stereo input), Mode 6	18	19 17.5	dB (max) dB (min)
	Volume Control Step Error		$\pm 0.2$		dB

- (1) Absolute Maximum Ratings indicate limits beyond which damage to the device may occur, including inoperability and degradation of device reliability and/or performance. Functional operation of the device and/or non-degradation at the Absolute Maximum Ratings or other conditions beyond those indicated in the Recommended Operating Conditions is not implied. The Recommended Operating Conditions indicate conditions at which the device is functional and the device should not be operated beyond such conditions. All voltages are measured with respect to the ground pin, unless otherwise specified.
- (2) The Electrical Characteristics tables list specified specifications under the listed Recommended Operating Conditions except as otherwise modified or specified by the Electrical Characteristics Conditions and/or Notes. Typical specifications are estimations only and are not ensured.
- (3) Loudspeaker  $R_L$  is a resistive load in series with two inductors to simulate an actual speaker load. For  $R_L = 8\Omega$ , the load is  $15\mu\text{H} + 8\Omega + 15\mu\text{H}$ . For  $R_L = 4\Omega$ , the load is  $15\mu\text{H} + 4\Omega + 15\mu\text{H}$ .
- (4) Typical values represent most likely parametric norms at  $T_A = +25^\circ\text{C}$ , and at the Recommended Operation Conditions at the time of product characterization and are not ensured.
- (5) Datasheet min/max specification limits are ensured by test or statistical analysis.

**Electrical Characteristics<sup>(1)(2)(3)</sup> (continued)**

The following specifications apply for  $A_V = 0\text{dB}$ ,  $R_L = 15\mu\text{H} + 8\Omega + 15\mu\text{H}$  (Loudspeaker),  $R_L = 32\Omega$  (Headphone),  $C_{\text{SET}} = 100\text{nF}$ ,  $f = 1\text{kHz}$ , ALC off, unless otherwise specified. Limits apply for  $T_A = 25^\circ\text{C}$ .

Parameter		Test Conditions	LM49251		Units (Limits)	
			Typ <sup>(4)</sup>	Limit <sup>(5)</sup>		
$A_V$	Gain	LS Mode				
		Gain 0	12	11.5 12.5	dB (min) dB (max)	
		Gain 1	18	17.5 19	dB (min) dB (max)	
		HP Mode				
		Gain 0	0	-0.5 0.5	dB (min) dB (max)	
		Gain 1	-1.7		dB	
		Gain 2	-3		dB	
		Gain 3	-6		dB	
		Gain 4	-9		dB	
		Gain 5	-12		dB	
		Gain 6	-15		dB	
		Gain 7	-18	-18.5 -17.5	dB (min) dB (max)	
$A_{V(\text{MUTE})}$	Mute Attenuation	LS Output	-93		dB	
		HP Output	-98		dB	
$R_{\text{IN}}$	Input Resistance	MONO, $R_{\text{IN}}$ , $L_{\text{IN}}$ inputs				
		Maximum Gain Setting	13	9.5 15.5	k $\Omega$ (min) k $\Omega$ (max)	
		Minimum Gain Setting	110	97 122	k $\Omega$ (min) k $\Omega$ (max)	
$P_O$	Output Power	Mode 3, $A_V = 18\text{dB}$ , $R_L = 8\Omega$				
		$LSV_{\text{DD}} = 3.3\text{V}$	570		mW	
		$LSV_{\text{DD}} = 3.6\text{V}$	680	600	mW (min)	
		$LSV_{\text{DD}} = 4.2\text{V}$	955		mW	
		$LSV_{\text{DD}} = 5.0\text{V}$	1370		mW	
		Mode 6				
		$R_L = 16\Omega$	20		mW	
$R_L = 32\Omega$	20	16	mW (min)			
THD+N	Total Harmonic Distortion + Noise	$f = 1\text{kHz}$ , Mode 3 Mono Input, $P_O = 250\text{mW}$	0.02		%	
		$f = 1\text{kHz}$ , Mode 6 Stereo Input, $P_O = 12\text{mW}$	0.02		%	
PSRR	Power Supply Rejection Ratio	$f = 217\text{Hz}$ , $V_{\text{RIPPLE}} = 200\text{mV}_{\text{P-P}}$ , Inputs AC GND, $C_B = 2.2\mu\text{F}$				
		Mode 3, mono input, $A_V = 6\text{dB}$	77		dB	
		Mode 2, stereo input, $A_V = 6\text{dB}$	65		dB	
		Mode 4, ripple on $V_{\text{DD}}$ , mono input	93		dB	
		Mode 4, ripple on $HPV_{\text{DD}}$ , mono input	83		dB	
		Mode 6, ripple on $V_{\text{DD}}$ , stereo input	80		dB	
		Mode 6, ripple on $HPV_{\text{DD}}$ , stereo input	80		dB	
CMRR	Common Mode Rejection Ratio	$V_{\text{RIPPLE}} = 1\text{V}_{\text{P-P}}$ , $f_{\text{RIPPLE}} = 217\text{Hz}$ , mono input				
		Mode 3	52		dB	
	Mode 4	63		dB		
$\eta$	Efficiency	LS Mode, $P_O = 680\text{mW}$	90		%	
$X_{\text{TALK}}$	Crosstalk	$P_O = 12\text{mW}$ , $f = 1\text{kHz}$ , Mode 6	84		dB	

### Electrical Characteristics<sup>(1)(2)(3)</sup> (continued)

The following specifications apply for  $A_V = 0\text{dB}$ ,  $R_L = 15\mu\text{H} + 8\Omega + 15\mu\text{H}$  (Loudspeaker),  $R_L = 32\Omega$  (Headphone),  $C_{\text{SET}} = 100\text{nF}$ ,  $f = 1\text{kHz}$ , ALC off, unless otherwise specified. Limits apply for  $T_A = 25^\circ\text{C}$ .

Parameter		Test Conditions	LM49251		Units (Limits)
			Typ <sup>(4)</sup>	Limit <sup>(5)</sup>	
$\epsilon_{\text{OS}}$	Output Noise	A-weighted, Inputs AC GND			
		Mode 3, mono input	44		$\mu\text{V}$
		Mode 2, stereo input	45		$\mu\text{V}$
		Mode 4, mono input	8		$\mu\text{V}$
		Mode 6, stereo input	10.2		$\mu\text{V}$
SNR	Signal-To-Noise-Ratio	Mode 3, $P_O = 680\text{mW}$	94		dB
		Mode 6, $P_O = 20\text{mW}$	98		dB
$t_A$	Attack Time	Step 1, Mode 1	0.75		ms
$t_R$	Release Time	Step 1, Mode 1	1		s
$V_{\text{LIMIT}}$	Output Voltage Limit	Mode 3, $\text{THD} + \text{N} \leq 1\%^{(6)}$			
		Voltage Level			
		Step 1 001	3.9		$V_{\text{P-P}}$
		Step 2 010	4.7		$V_{\text{P-P}}$
		Step 3 011	5.4		$V_{\text{P-P}}$
		Step 4 100	6.2		$V_{\text{P-P}}$
		Step 5 101	7.0		$V_{\text{P-P}}$
Step 6 110	7.8		$V_{\text{P-P}}$		

(6) The LM49251 ALC limits the output power to which ever is lower, the supply voltage or output power limit.

### I<sup>2</sup>C Interface Characteristics $V_{\text{DD}} = 5\text{V}$ , $2.2\text{V} \leq I^2\text{C}V_{\text{DD}} \leq 5.5\text{V}^{(1)(2)}$

The following specifications apply for  $A_V = 0\text{dB}$ ,  $R_L = 8\Omega$ ,  $f = 1\text{kHz}$ , unless otherwise specified. Limits apply for  $T_A = 25^\circ\text{C}$ .

Parameter		Test Conditions	LM49251		Units (Limits)
			Typ <sup>(3)</sup>	Limit <sup>(4)</sup>	
$t_1$	SCL Period			2.5	$\mu\text{s}$ (min)
$t_2$	SDA Set-up Time			100	ns (min)
$t_3$	SDA Stable Time			0	ns (min)
$t_4$	Start Condition Time			100	ns (min)
$t_5$	Stop Condition Time			100	ns (min)
$t_6$	SDA Hold time			100	ns (min)
$V_{\text{IH}}$	Input High Voltage			$0.7 \cdot I^2\text{C}V_{\text{DD}}$	V (min)
$V_{\text{IL}}$	Input Low Voltage			$0.3 \cdot I^2\text{C}V_{\text{DD}}$	V (max)

- (1) Absolute Maximum Ratings indicate limits beyond which damage to the device may occur, including inoperability and degradation of device reliability and/or performance. Functional operation of the device and/or non-degradation at the Absolute Maximum Ratings or other conditions beyond those indicated in the Recommended Operating Conditions is not implied. The Recommended Operating Conditions indicate conditions at which the device is functional and the device should not be operated beyond such conditions. All voltages are measured with respect to the ground pin, unless otherwise specified.
- (2) The Electrical Characteristics tables list specified specifications under the listed Recommended Operating Conditions except as otherwise modified or specified by the Electrical Characteristics Conditions and/or Notes. Typical specifications are estimations only and are not ensured.
- (3) Typical values represent most likely parametric norms at  $T_A = +25^\circ\text{C}$ , and at the Recommended Operation Conditions at the time of product characterization and are not ensured.
- (4) Datasheet min/max specification limits are ensured by test or statistical analysis.

**I<sup>2</sup>C Interface Characteristics  $V_{DD} = 5V, 1.8V \leq I^2CV_{DD} \leq 2.2V$ <sup>(1)(2)</sup>**

The following specifications apply for  $A_V = 0dB$ ,  $R_L = 8\Omega$ ,  $f = 1kHz$ , unless otherwise specified. Limits apply for  $T_A = 25^\circ C$ .

Parameter		Test Conditions	LM49251		Units (Limits)
			Typ <sup>(3)</sup>	Limit <sup>(4)</sup>	
$t_1$	SCL Period			2.5	$\mu s$ (min)
$t_2$	SDA Set-up Time			250	ns (min)
$t_3$	SDA Stable Time			0	ns (min)
$t_4$	Start Condition Time			250	ns (min)
$t_5$	Stop Condition Time			250	ns (min)
$t_6$	SDA Hold Time			250	ns (min)
$V_{IH}$	Digital Input High Voltage			$0.7 \cdot I^2CV_{DD}$	V (min)
$V_{IL}$	Digital Input Low Voltage			$0.3 \cdot I^2CV_{DD}$	V (max)

- (1) Absolute Maximum Ratings indicate limits beyond which damage to the device may occur, including inoperability and degradation of device reliability and/or performance. Functional operation of the device and/or non-degradation at the Absolute Maximum Ratings or other conditions beyond those indicated in the Recommended Operating Conditions is not implied. The Recommended Operating Conditions indicate conditions at which the device is functional and the device should not be operated beyond such conditions. All voltages are measured with respect to the ground pin, unless otherwise specified
- (2) The Electrical Characteristics tables list specified specifications under the listed Recommended Operating Conditions except as otherwise modified or specified by the Electrical Characteristics Conditions and/or Notes. Typical specifications are estimations only and are not ensured.
- (3) Typical values represent most likely parametric norms at  $T_A = +25^\circ C$ , and at the Recommended Operation Conditions at the time of product characterization and are not ensured.
- (4) Datasheet min/max specification limits are ensured by test or statistical analysis.

## Typical Performance Characteristics

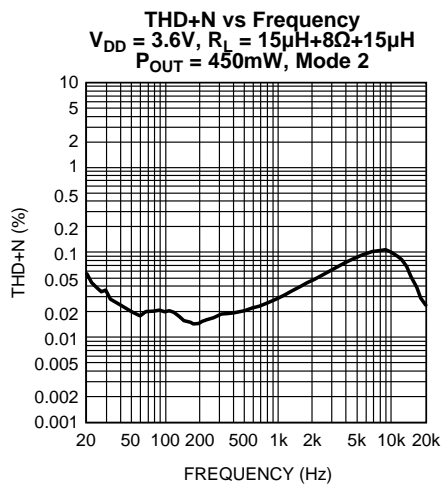

Figure 4.

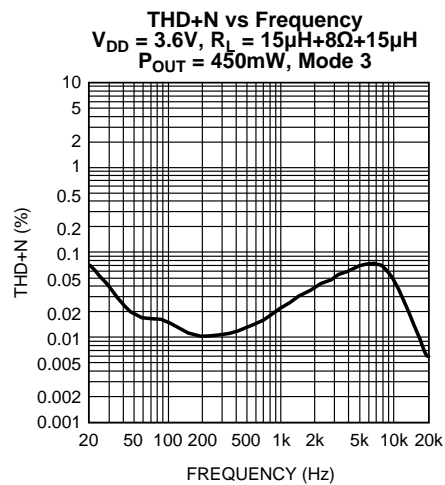

Figure 5.

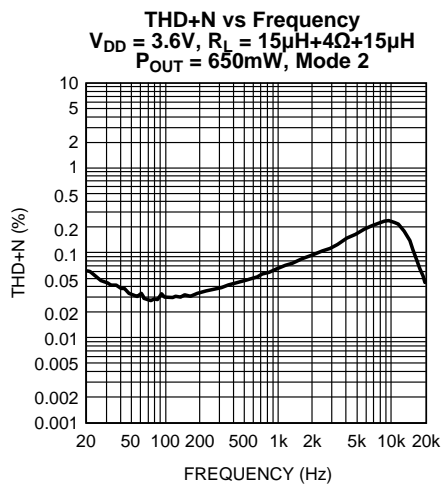

Figure 6.

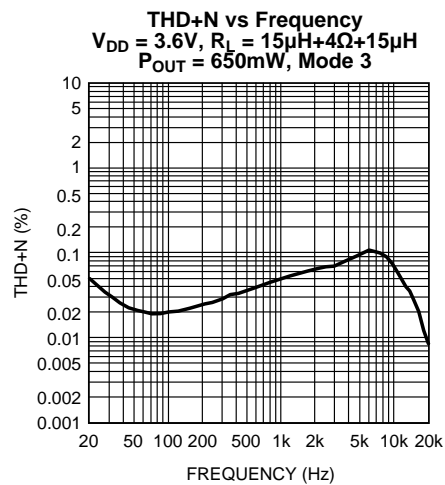

Figure 7.

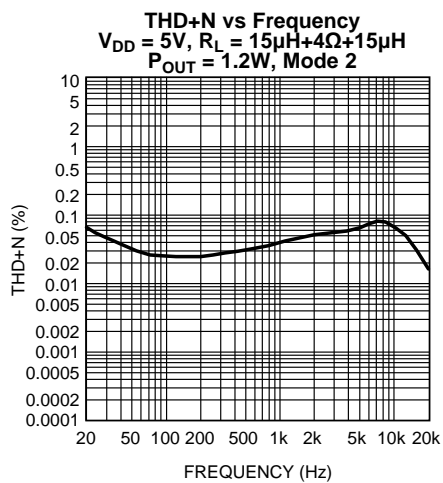

Figure 8.

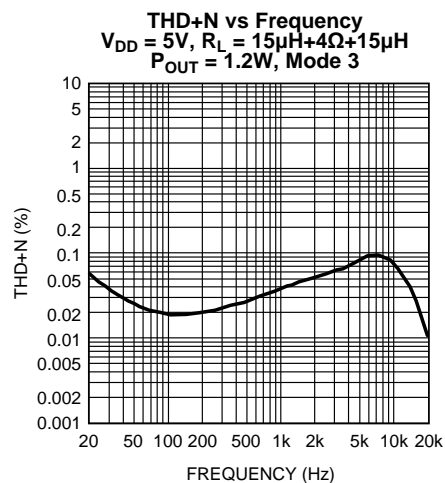

Figure 9.

Typical Performance Characteristics (continued)

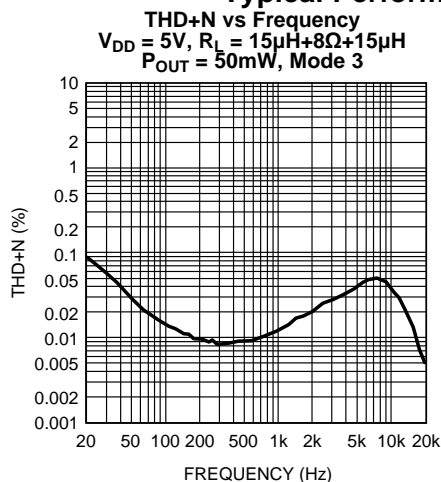

Figure 10.

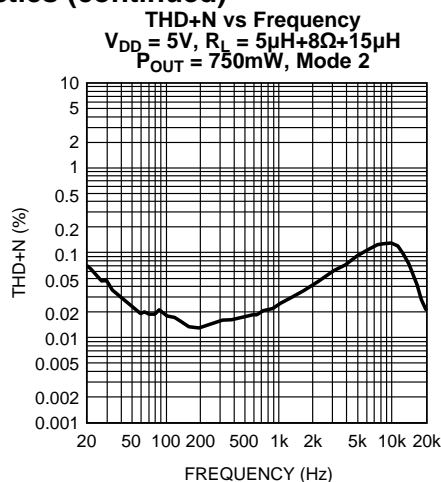

Figure 11.

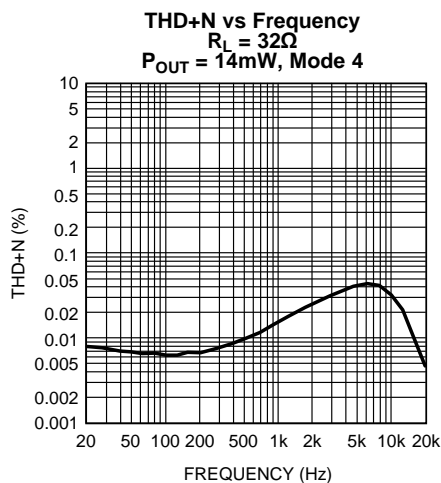

Figure 12.

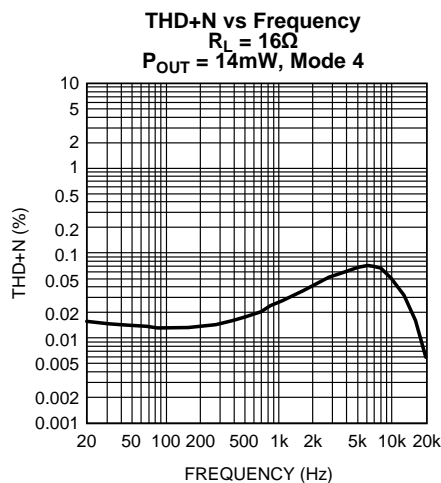

Figure 13.

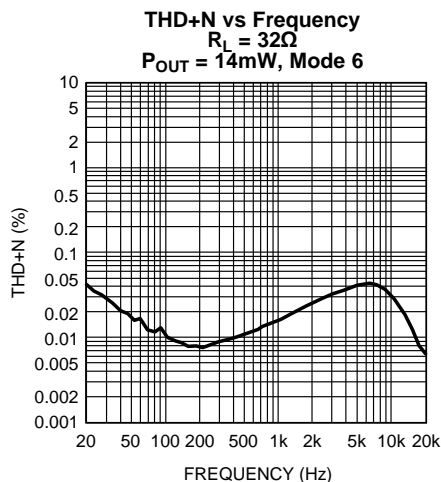

Figure 14.

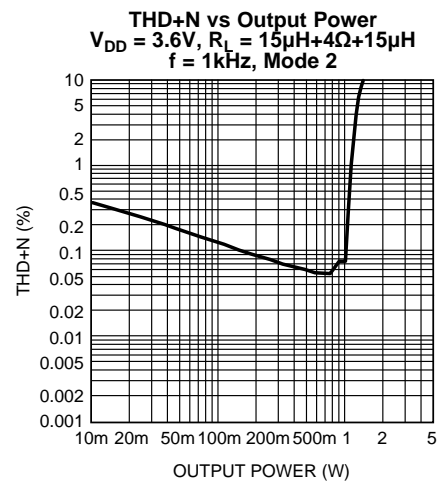

Figure 15.

**Typical Performance Characteristics (continued)**

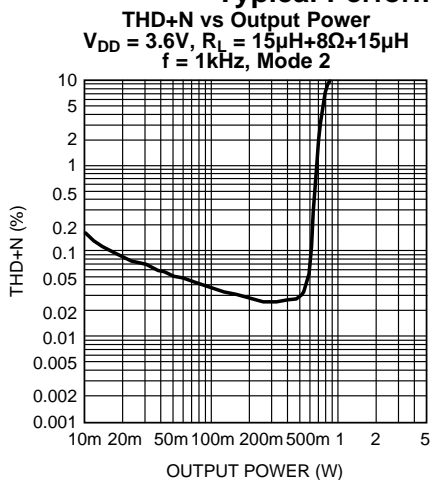

Figure 16.

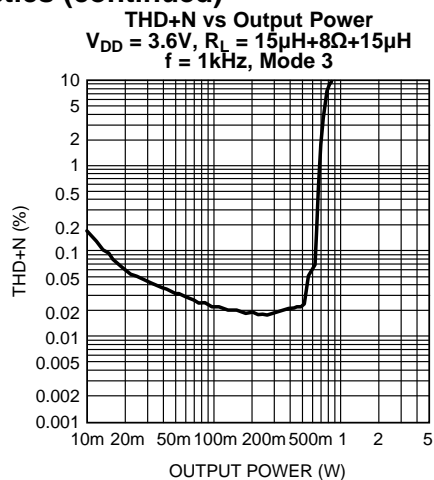

Figure 17.

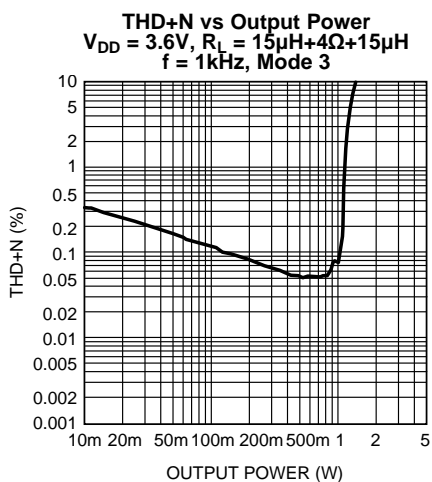

Figure 18.

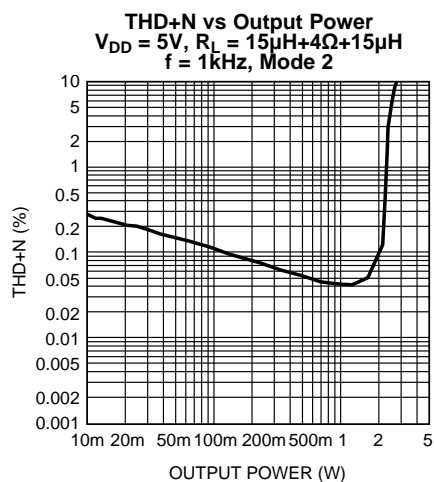

Figure 19.

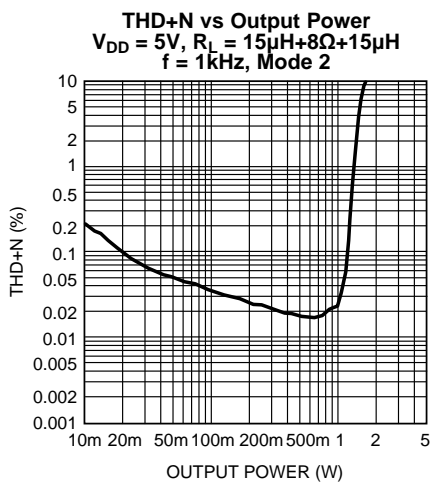

Figure 20.

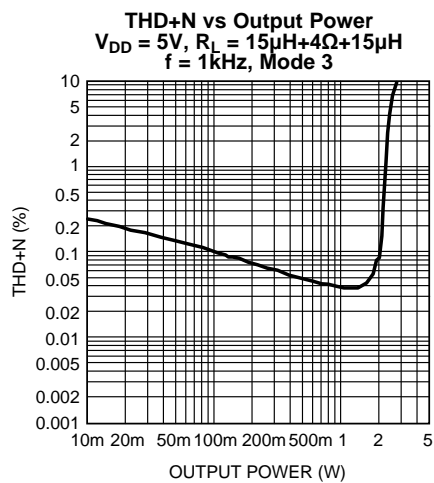

Figure 21.

Typical Performance Characteristics (continued)

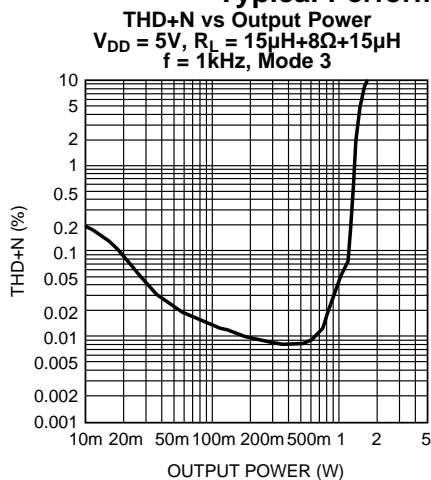

Figure 22.

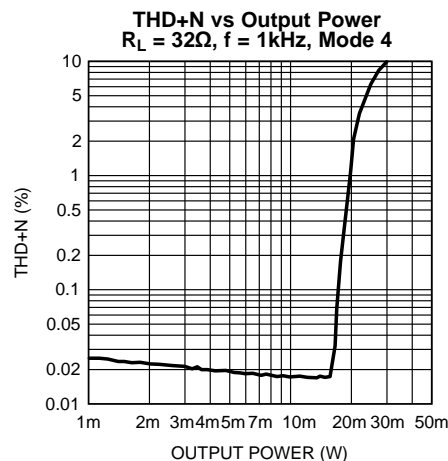

Figure 23.

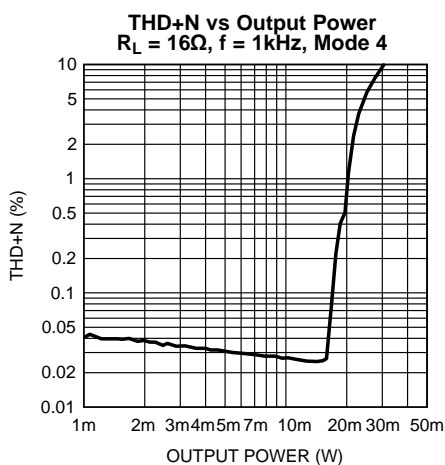

Figure 24.

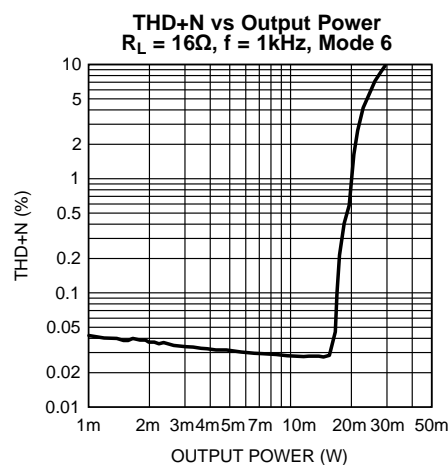

Figure 25.

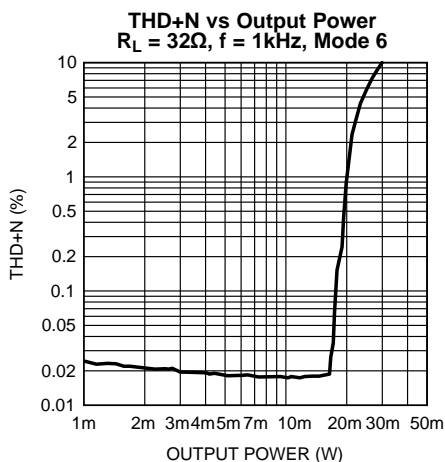

Figure 26.

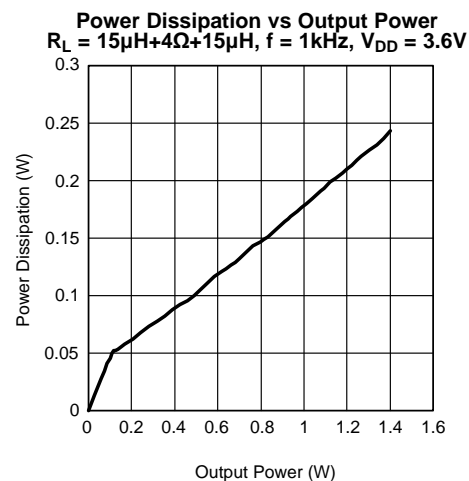
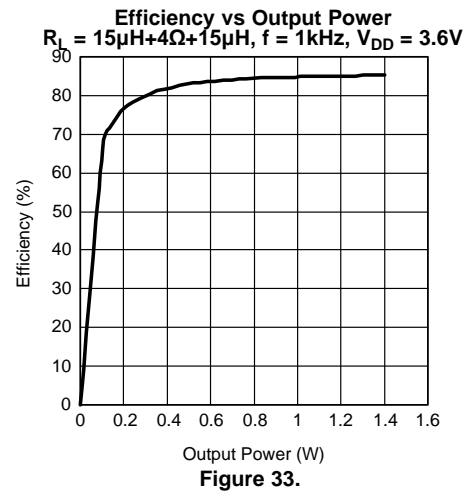
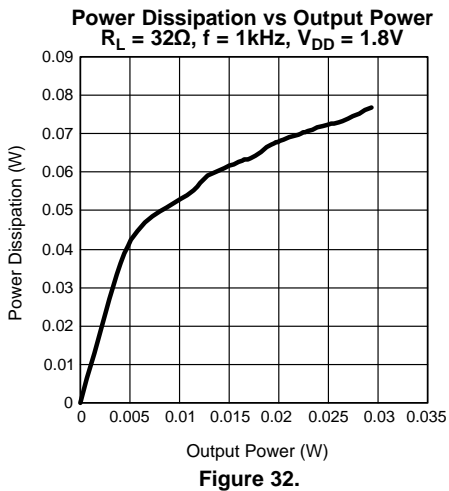
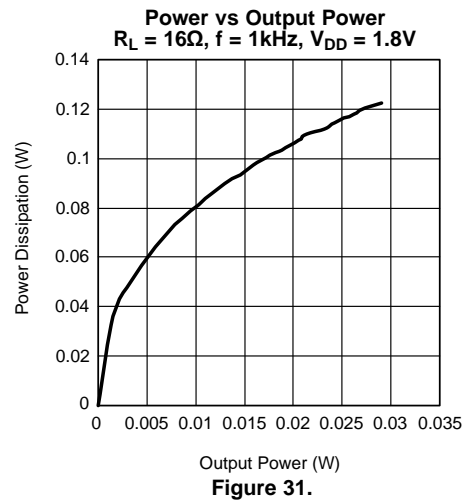
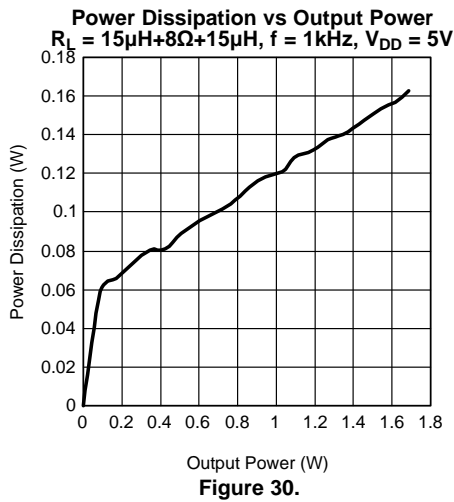
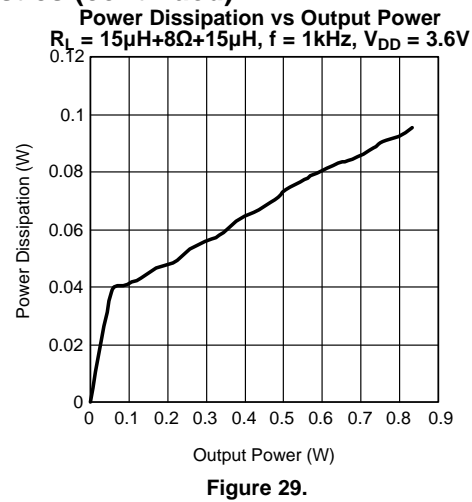
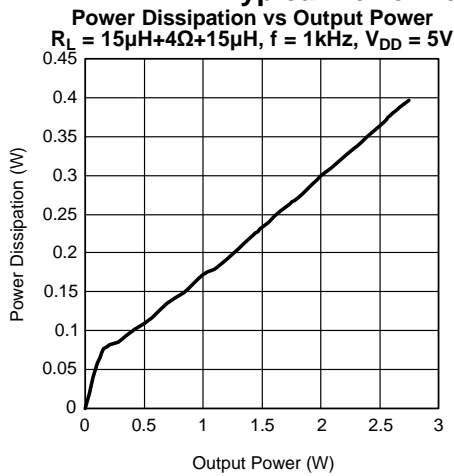

Figure 27.

**Typical Performance Characteristics (continued)**



Typical Performance Characteristics (continued)

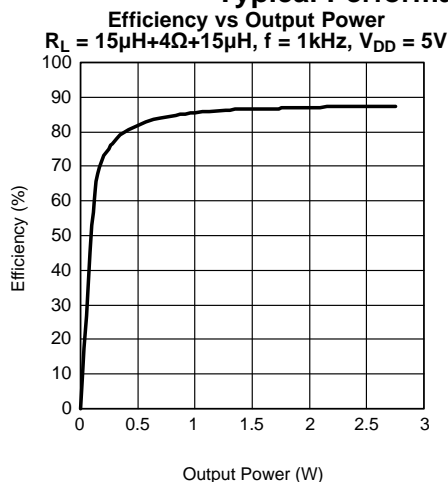

Figure 34.

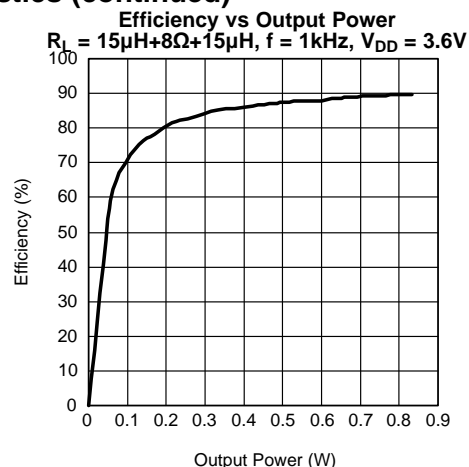

Figure 35.

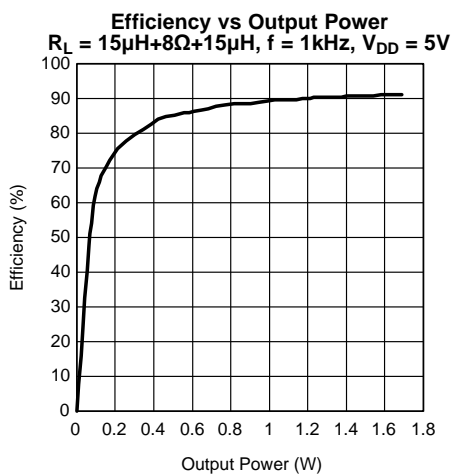

Figure 36.

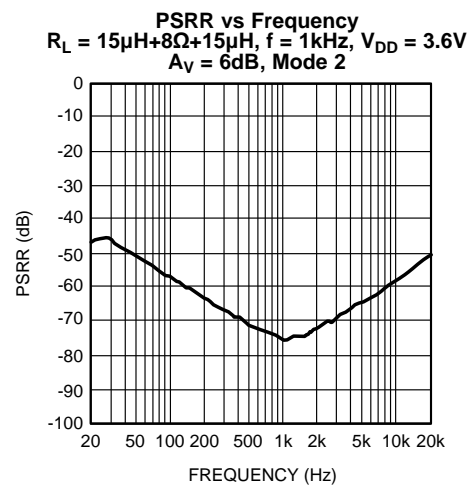

Figure 37.

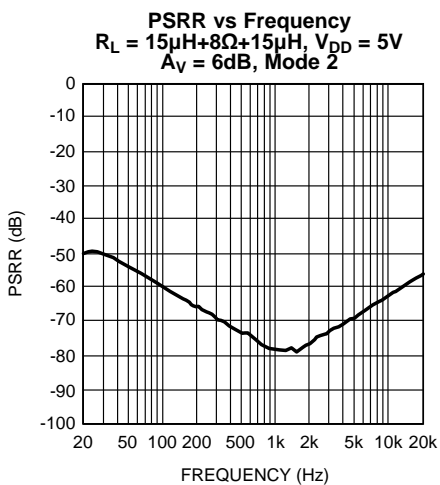

Figure 38.

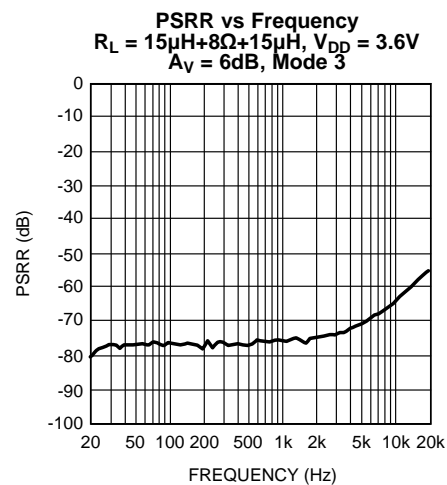

Figure 39.

**Typical Performance Characteristics (continued)**

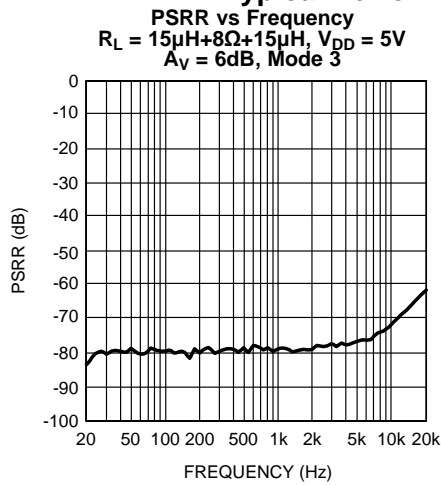

Figure 40.

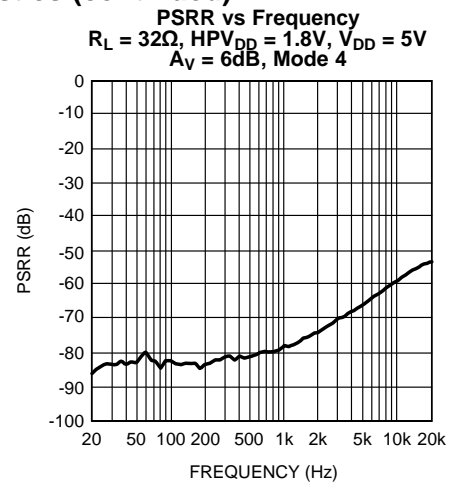

Figure 41.

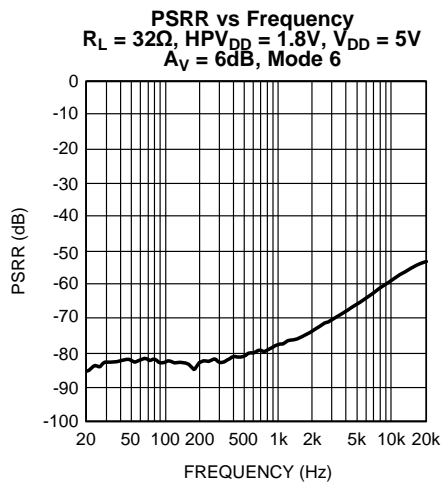

Figure 42.

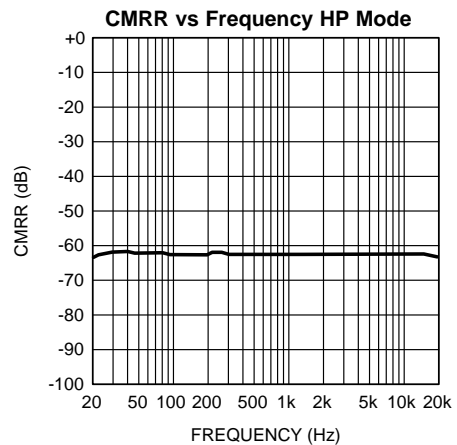

Figure 43.

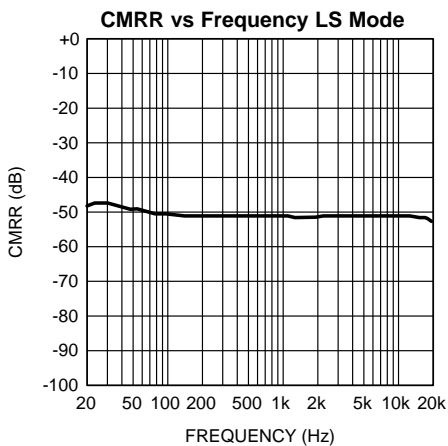

Figure 44.

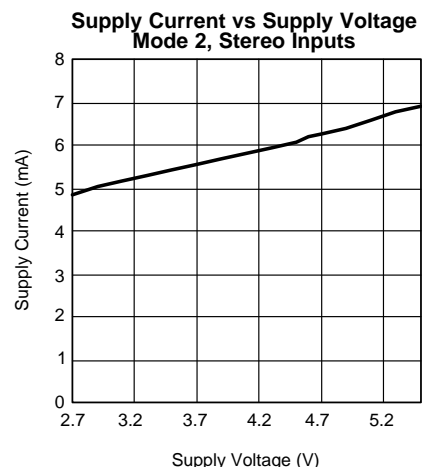
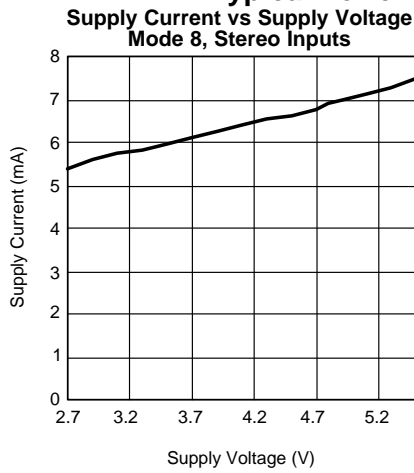
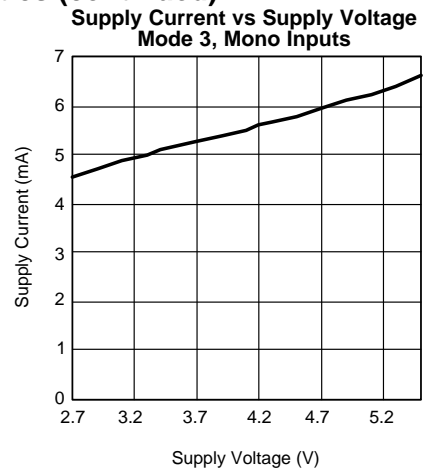

Figure 45.

**Typical Performance Characteristics (continued)**



**Figure 46.**



**Figure 47.**

## System Control

### I<sup>2</sup>C SIGNALS

In I<sup>2</sup>C mode the LM49251 pin SCL is used for the I<sup>2</sup>C clock SCL and the pin SDA is used for the I<sup>2</sup>C data signal SDA. Both of these signals need a pull-up resistor according to I<sup>2</sup>C specification. The 7-bits I<sup>2</sup>C slave address for LM49251 is 1111100.

### I<sup>2</sup>C DATA VALIDITY

The data on SDA line must be stable during the HIGH period of the clock signal (SCL). In other words, state of the data line can only be changed when SCL is LOW.

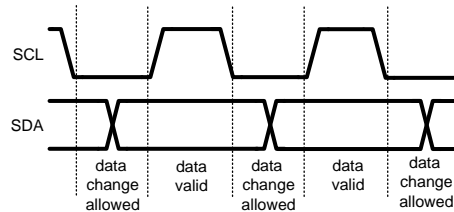

Figure 48. I<sup>2</sup>C Signals: Data Validity

### I<sup>2</sup>C START AND STOP CONDITIONS

START and STOP bits classify the beginning and the end of the I<sup>2</sup>C session. START condition is defined as SDA signal transitioning from HIGH to LOW while SCL line is HIGH. STOP condition is defined as the SDA transitioning from LOW to HIGH while SCL is HIGH. The I<sup>2</sup>C master always generates START and STOP bits. The I<sup>2</sup>C bus is considered to be busy after START condition and free after STOP condition. During data transmission, I<sup>2</sup>C master can generate repeated START conditions. First START and repeated START conditions are equivalent, function-wise.

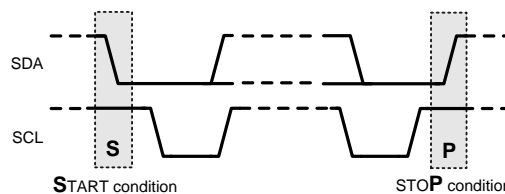

Figure 49. I<sup>2</sup>C Start and Stop Conditions

### TRANSFERRING DATA

Every byte put on the SDA line must be eight bits long, with the most significant bit (MSB) being transferred first. Each byte of data has to be followed by an acknowledge bit. The acknowledge related clock pulse is generated by the master. The transmitter releases the SDA line (HIGH) during the acknowledge clock pulse. The receiver must pull down the SDA line during the 9th clock pulse, signifying an acknowledge. A receiver which has been addressed must generate an acknowledge after each byte has been received. After the START condition, the I<sup>2</sup>C master sends a chip address. This address is seven bits long followed by an eight bit which is a data direction bit (R/W). The LM49251 address is 11111000. For the eighth bit, a "0" indicates a WRITE and a "1" indicates a READ. The second byte selects the register to which the data will be written. The third byte contains data to write to the selected register.

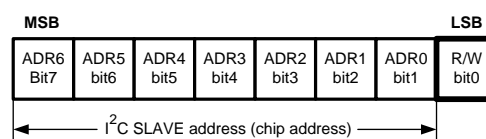

Figure 50. I<sup>2</sup>C Chip Address

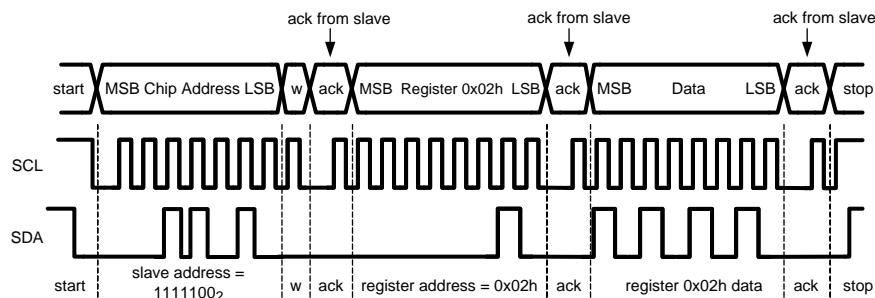
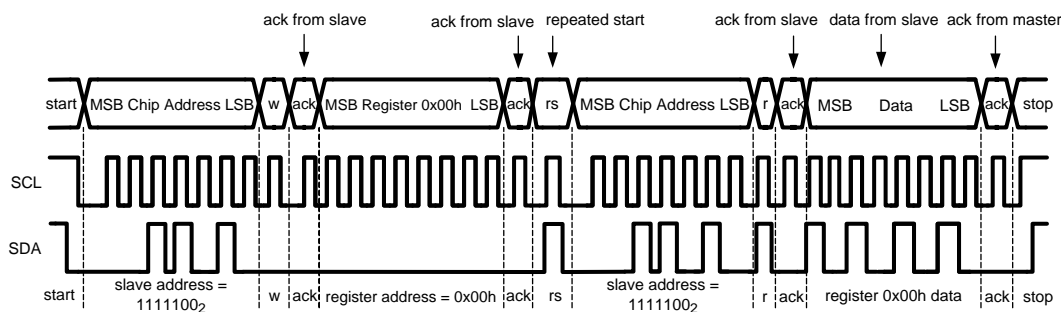

Figure 51. Example I<sup>2</sup>C Write Cycle

When a READ function is to be accomplished, a WRITE function must precede the READ function, as shown in the Read Cycle waveform.



w = write (SDA = "0")  
 r = read (SDA = "1")  
 ack = acknowledge (SDA pulled down by slave)  
 rs = repeated start

Figure 52. Example I<sup>2</sup>C Read Cycle

Table 2. Device Address

	B7	B6	B5	B4	B3	B2	B1	B0
Device Address	1	1	1	1	1	0	0	0

Table 3. I<sup>2</sup>C Control Registers

Register Name	B7	B6	B5	B4	B3	B2	B1	B0
SHUTDOWN CONTROL	0	0	0	1	GAMP_ON	HPR_SD	Class G_SD	$\overline{SD}$
MODE CONTROL	0	0	1	HP_ST	HP_M	SPK_L+R	SPK_ST	SPK_M
POWER LIMITER CONTROL	0	1	0	ATK1	ATK0	PLEV2	PLEV1	PLEV0
NO CLIP CONTROL	0	1	1	RLT1	RLT0	OCP2	OCP1	OCP0
GAIN CONTROL	1	0	0	LSGAINL	LSGAINR	HPGAIN2	HPGAIN1	HPGAIN0
MONO VOLUME CONTROL	1	0	1	MG4	MG3	MG2	MG1	MG0
STEREO VOLUME CONTROL	1	1	0	SG4	SG3	SG2	SG1	SG0

**Table 3. I<sup>2</sup>C Control Registers (continued)**

Register Name	B7	B6	B5	B4	B3	B2	B1	B0
CLASS D CONTROL	1	1	1	0	0	0	ER_CNTRL	SS_EN
LS CONTROL	1	1	1	0	1	0	ST_SEL	LSR_SD
CLASS G CONTROL	1	1	1	1	0	0	TLEV1	TLEV2
OTHER CONTROL	1	1	1	1	1	I <sup>2</sup> CV <sub>DD</sub> SD	RAIL_SW	TURN_ON TIME

**Table 4. Shutdown Control**

BIT	NAME	VALUE	DESCRIPTION
B3	GAMP_ON	This disables the gain amplifiers that are not in use to minimize I <sub>DD</sub> .	
		0	Normal Operation
		1	Unused gain amplifiers disabled
B2	HPR_SD	This disables the right headphone output.	
		0	Normal operation
		1	Right headphone amplifier disabled
B1	Class G_SD	This disables the Class G.	
		0	Class G enabled
		1	Class G disabled
B0	SD	LM49251 Shutdown	
		0	LM49251 Disabled
		1	LM49251 Enabled

**Table 5. Output Mode Selection**

HP (ST)	HP (M)	SPK (L+R)	SPK (ST)	SPK (M)	SPK(L)	SPK(R)	HP(L)	HP(R)	Datasheet
0	0	0	0	0	SD	SD	SD	SD	Mode 0
0	0	1	1	0	GST X (L + R)	GST X (L + R)	SD	SD	Mode 1
0	0	0	1	0	GST X L	GST X R	SD	SD	Mode 2
0	0	0	0	1	GM X M	GM X M	SD	SD	Mode 3
0	1	0	0	0	SD	SD	GM X M	GM X M	Mode 4
0	1	0	0	1	GM X M	GM X M	GM X M	GM X M	Mode 5
1	0	0	0	0	SD	SD	GSTX L	GST X R	Mode 6
1	0	1	1	0	GST X (L + R)	GST X (L + R)	GSTX L	GST X R	Mode 7
1	0	0	1	0	GST X L	GST X R	GSTX L	GST X R	Mode 8

**Table 6. Voltage Limit Control Register**

BIT	NAME	VALUE			DESCRIPTION
B4:B3	ATK1 ATK2	B4		B3	Sets Attack Time based on C <sub>SET</sub> and R <sub>SET</sub>  t <sub>ATK</sub> 1.3 x t <sub>ATK</sub> 2 x t <sub>ATK</sub> 2.7 x t <sub>ATK</sub>
		0		0	
		0		1	
		1		0	
B2:B0	PLEV2 PLEV1 PLEV0	B2 B1 B0			Sets output power limit level
		0	0	0	Voltage Limit disabled
		0	0	1	V <sub>TH(VLIM)</sub> = 3.9V <sub>P-P</sub>
		0	1	0	V <sub>TH(VLIM)</sub> = 4.7V <sub>P-P</sub>
		0	1	1	V <sub>TH(VLIM)</sub> = 5.4V <sub>P-P</sub>
		1	0	0	V <sub>TH(VLIM)</sub> = 6.2V <sub>P-P</sub>
		1	0	1	V <sub>TH(VLIM)</sub> = 7.0V <sub>P-P</sub>
		1	1	0	V <sub>TH(VLIM)</sub> = 7.8V <sub>P-P</sub>
1	1	1	Voltage Limit disabled		

**Table 7. No Clip Control Register**

BIT	NAME	VALUE			DESCRIPTION
B2:B0	OCP2 OCP1 OCP0	B2 B1 B0			This sets the output clip limit level
		0	0	0	NO_CLIP = disabled, OUTPUT_CLIP = disabled
		0	0	1	Test Mode
		0	1	0	NO_CLIP = enabled, OUTPUT_CLIP = disabled
		0	1	1	low
		1	0	0	medium
		1	0	1	medium high
		1	1	0	high
B4:B3	RLT1 RTL0	B1 B0			This sets the release time of the automatic limiter control circuit.
		0	0		1s
		0	1		0.8s
		1	0		0.65s
		1	1		0.4s

**Table 8. Gain Control Register**

BIT	NAME	VALUE	DESCRIPTION
B4	LSGAINL	0	6dB Loudspeaker gain
		1	12dB Loudspeaker gain
B3	LSGAINR	0	6dB Loudspeaker gain
		1	12dB Loudspeaker gain

**Table 8. Gain Control Register (continued)**

BIT	NAME	VALUE			DESCRIPTION
		B2	B1	B0	
B2:B0	HPGAIN2 (B2) HPGAIN1 (B1) HPGAIN0 (B0)	0	0	0	Headphone Gain 0dB
		0	0	1	-1.5dB
		0	1	0	-3dB
		0	1	1	-6dB
		1	0	0	-9dB
		1	0	1	-12dB
		1	1	0	-15dB
		1	1	1	-18dB

**General Amplifier Function****Table 9. Volume Control Table**

VOLUME STEP	_G4	_G3	_G2	_G1	_G0	GAIN (dB)
1	0	0	0	0	0	-80
2	0	0	0	0	1	-46.5
3	0	0	0	1	0	-40.5
4	0	0	0	1	1	-34.5
5	0	0	1	0	0	-30
6	0	0	1	0	1	-27
7	0	0	1	1	0	-24
8	0	0	1	1	1	-21
9	0	1	0	0	0	-18
10	0	1	0	0	1	-15
11	0	1	0	1	0	-13.5
12	0	1	0	1	1	-12
13	0	1	1	0	0	-10.5
14	0	1	1	0	1	-9
15	0	1	1	1	0	-7.5
16	0	1	1	1	1	-6
17	1	0	0	0	0	-4.5
18	1	0	0	0	1	-3
19	1	0	0	1	0	1.5
20	1	0	0	1	1	0
21	1	0	1	0	0	1.5
22	1	0	1	0	1	3
23	1	0	1	1	0	4.5
24	1	0	1	1	1	6
25	1	1	0	0	0	7.5
26	1	1	0	0	1	9
27	1	1	0	1	0	10.5
28	1	1	0	1	1	12
29	1	1	1	0	0	X
30	1	1	1	0	1	X
31	1	1	1	1	0	X
32	1	1	1	1	1	X

**Table 10. Class D Control**

BIT	NAME	VALUE	DESCRIPTION
B1	ER_CNTRL	This enables edge rate control.	
		0	Edge Rate Control Disabled
		1	Edge Rate Control Enabled
B0	SS_EN	This enables Spread Spectrum.	
		0	Spread Spectrum Disabled
		1	Spread Spectrum Enabled

**Table 11. Loudspeaker (LS) Control**

BIT	NAME	VALUE	DESCRIPTION
B1	ST_SEL	This allows selection between two Stereo Inputs.	
		0	LIN1/RIN1
		1	LIN2/RIN2
B0	LSR_SD	This disables the Left Loudspeaker.	
		0	Left Loudspeaker enabled
		1	Left Loudspeaker disabled

**Table 12. Class G Control**

BIT	NAME	VALUE		DESCRIPTION
		B1	B0	
B1:B0	TLEV1 TLEV0	This sets the Trip Level.		
		0	0	High (default)
		0	1	High-Medium
		1	0	Low-Medium
		1	1	Low

**Table 13. Other Control**

BIT	NAME	VALUE	DESCRIPTION
B1	RAIL_SW	This switches between two HP voltage rails <sup>(1)</sup>	
		0	High Rail
		1	Low Rail
B0	TURN_ON_TIME	This allows fast turn on time	
		0	Normal Turn-On Time
		1	Fast Turn-On Time

(1) This option is only available when the Class G is disabled.

## APPLICATION INFORMATION

### DIFFERENTIAL AMPLIFIER EXPLANATION

The LM49251 features a differential input stage, which offers improved noise rejection compared to a single-ended input amplifier. Because a differential input amplifier amplifies the difference between the two input signals, any component common to both signals is cancelled. An additional benefit of the differential input structure is the possible elimination of the DC input blocking capacitors. Since the DC component is common to both inputs, and thus cancelled by the amplifier, the LM49251 can be used without input coupling capacitors when configured with a differential input signal.

### INPUT MIXER/MULTIPLEXER

The LM49251 includes a comprehensive mixer multiplexer controlled through the I<sup>2</sup>C interface. The mixer/multiplexer allows any input combination to appear on any output of LM49251. [Table 5](#) (MODE CONTROL) shows how the input signals are routed together for each possible input selection.

### SHUTDOWN FUNCTION

The LM49251 features the following shutdown controls: Bit B4 (GAMP\_SD) of the SHUTDOWN CONTROL register controls the gain amplifiers. When GAMP\_SD = 1, it disables the gain amplifiers that are not in use. For example, in Modes 1, 4 and 5, the Mono inputs are in use, so the Left and Right input gain amplifiers are disabled, causing the I<sub>DD</sub> to be minimized. Bit B0 (PWR\_ON) of the SHUTDOWN CONTROL register is the global shutdown control for the entire device. Set PWR\_ON = 0 for normal operation. PWR\_ON = 1 overrides any other shutdown control bit.

### CLASS D AMPLIFIER

The LM49251 features a mono class D audio power amplifier with a filterless modulation scheme that reduces external component count, conserving board space and reducing system cost. With no signal applied, the outputs (LSOUT+ and LSOUT-) switch between V<sub>DD</sub> and GND with 50% duty cycle, in phase, causing the two outputs to cancel. This cancellation results in no net voltage across the speaker, thus there is no current to the load in the idle state.

With an input signal applied, the duty cycle (pulse width) of the class D output changes. For increasing output voltage, the duty cycle of LSOUT+ increases, while the duty cycle of LSOUT- decreases. For decreasing output voltages, the converse occurs. The difference between the two pulse widths yields the differential output voltage.

### ENHANCED EMISSIONS SUPPRESSION (E<sup>2</sup>S)

The LM49251 class D amplifier features TI's patent-pending E<sup>2</sup>S system that reduces EMI, while maintaining high quality audio reproduction and efficiency. The E<sup>2</sup>S system features selectable spread spectrum and advanced edge rate control (ERC). The LM49251 class D ERC greatly reduces the high frequency components of the output square waves by controlling the output rise and fall times, slowing the transitions to reduce RF emissions, while maximizing THD+N and efficiency performance.

### FIXED FREQUENCY

The LM49251 class D amplifier features two modulation schemes, a fixed frequency mode and a spread spectrum mode. Select the fixed frequency mode by setting bit B0 (SS\_EN) of the SS Control register to 0. In fixed frequency mode, the loudspeaker outputs switch at a constant 300kHz. The output spectrum consists of the 300kHz fundamental and its associated harmonics.

### SPREAD SPECTRUM

The selectable spread spectrum mode minimizes the need for output filters, ferrite beads or chokes. In spread spectrum mode, the switching frequency varies randomly by 30% about a 300kHz center frequency, reducing the wideband spectral content, improving EMI emission radiated by the speaker and associated cables and traces. Where a fixed frequency class D exhibits large amounts of spectral energy at multiples of the switching frequency, the spread spectrum architecture spreads that energy over a larger bandwidth. The cycle-to-cycle variation of the switching period does not affect the audio reproduction, efficiency, or PSRR. Set bit B0 (SS\_EN) of the SS Control register to 1 to enable spread spectrum mode.

## GROUND REFERENCED HEADPHONE AMPLIFIER

The LM49251 features a low noise inverting charge pump that generates an internal negative supply voltage. This allows the headphone outputs to be biased about GND instead of a nominal DC voltage, like traditional headphone amplifiers. Because there is no DC component, the large DC blocking capacitors (typically 220 $\mu$ F) at the headphone outputs are not necessary. The coupling capacitors are replaced by two small ceramic charge pump capacitors, saving board space and cost. Eliminating the output coupling capacitors also improves low frequency response. In traditional headphone amplifiers, the headphone impedance and the output capacitor form a high-pass filter that not only blocks the DC component of the output, but also attenuates low frequencies, impacting the bass response. Because the LM49251 does not require the output coupling capacitors, the low frequency response of the device is not degraded by external components. In addition to eliminating the output coupling capacitors, the ground referenced output nearly doubles the available dynamic range of the LM49251 headphone amplifiers when compared to a traditional headphone amplifier operating from the same supply voltage.

## CLASS G OPERATION

The LM49251 features a ground referenced class G headphone amplifier for increased efficiency and decreased power dissipation. This particular architecture creates a ground-referenced output with dynamic supply rails for optimum efficiency. Music and voice signals have a high peak-to-mean ratio with the majority of the signal content at low levels, class G amplifiers take advantage of this behavior. Class G amplifiers have multiple voltage supplies to decrease power dissipation. The LM49251 has two discrete supply rails:  $\pm 0.9$ V and  $\pm 1.8$ V. The device switches from  $\pm 0.9$ V to  $\pm 1.8$ V when the output signal reaches the selectable threshold level to switch to the higher voltage rails. When the output falls below the required voltage for a set period of time, it will switch back to the lower rail until the next time the threshold is reached. The threshold level has 4 selectable levels that can be set through the Class G Control I<sup>2</sup>C control register <B1:B2>. With this topology power dissipation is reduced for typical music or voice sources. Figure 53 below shows how a music output may look.

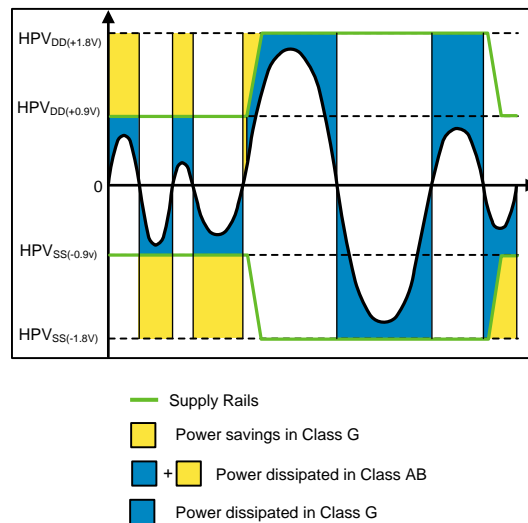
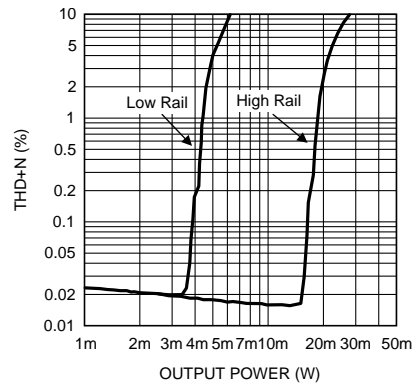

Figure 53. Class G Operation

## Disabling the Class G

The Class G feature can be disabled via I<sup>2</sup>C Shutdown Control Register B1. When the Class G is disabled the headphone supply rails are selectable. In the Other Control register B1 = 0 sets the headphone supply rails at  $\pm 1.8$ V (high) and B1 = 1 sets the supply to  $\pm 0.9$ V (low). Figure 54 below shows a curve of THD+N vs Output Power for the two supply rails.



**Figure 54. Class G Disabled (Low/High Supply Rails)**

### AUTOMATIC LIMITER CONTROL (ALC)

When enabled, the ALC continuously monitors and adjusts the gain of the loudspeaker amplifier signal path if necessary. The ALC serves two functions: voltage limiter/speaker protection and output clip prevention (No-Clip) with three clip controls levels. The voltage limiter/speaker protection prevents an output overload condition by maintaining the loudspeaker output signal below a preset amplitude (See [VOLTAGE LIMITER](#) section). The No Clip feature monitors the output signal and maintains audio quality by preventing the loudspeaker output from exceeding the amplifier's headroom (see [NO CLIP/OUTPUT CLIP CONTROL](#) section). The voltage limiter thresholds, clip control levels, attack and release times are configured through the I<sup>2</sup>C interface.

### VOLTAGE LIMITER

The voltage limiter function of the ALC monitors and prevents the audio signal from exceeding the voltage limit threshold. The voltage limit threshold ( $V_{TH(VLIM)}$ ) is set by bits B2:B0 in the "Voltage Limit Threshold Register" (see [Table 6](#)). Although the ALC reduces the gain of the speaker path to maintain the audio signal below the voltage limit threshold, it is still possible to overdrive the speaker output in which case loudspeaker output will exceed the voltage limit threshold and cause clipping on the output, and speaker damage is possible. Please see the [ALC HEADROOM](#) section for further details.

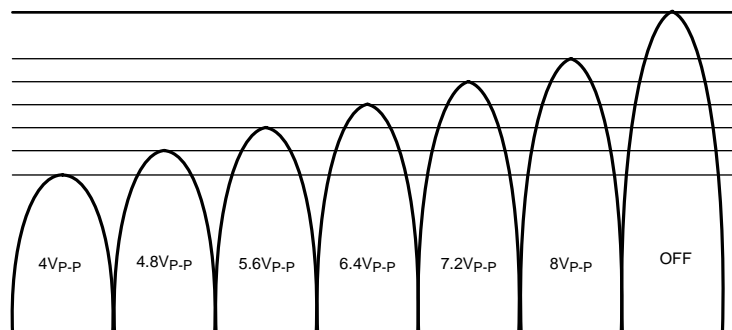

**Figure 55. Voltage Limit Output Level**

### NO CLIP/OUTPUT CLIP CONTROL

The LM49251 No Clip circuitry detects when the loudspeaker output is near clipping and reduces the signal gain to prevent output clipping and preserve audio quality ([Figure 54](#)). Although the ALC reduces the gain of the speaker path to prevent output clipping, it is still possible to overdrive the speaker output. Please see the [ALC HEADROOM](#) section for further details.

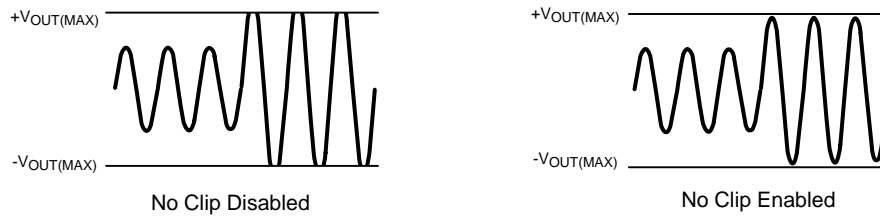

**Figure 56. No Clip Function**

The LM49251 also features an output clip control that allows a certain amount of clipping at the output in order to increase the loudspeaker output power. The clip level is set by B2:B0 in the No Clip Control Register (see Table 7). The clip control works by allowing the output to enter clipping before the ALC turns on and maintains the output level. The clip control has three levels: low, medium, and high. The low and max clip level control settings give the lowest distortion and highest distortion respectively on the output (see Figure 57). The actual output level of the device will depend upon the supply voltage, and the output power will depend upon the load impedance.

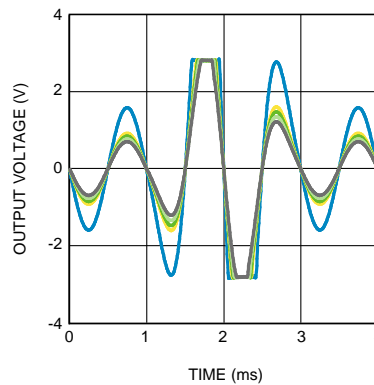

**Figure 57. Clip Control Levels**  
 $V_{DD} = 3.3V$ ,  $V_{IN} = 8V_{PP}$  Shaped Burst, 1kHz  
 Blue = No Clip Disabled, Gray = Low, Light Green = Medium  
 Green = High, Yellow = Max

## ALC HEADROOM

When either voltage limiter or no clip is enabled, it is still possible to drive LM49251 into clipping by over driving the input volume stage of the signal path beyond its output dynamic range. In this case, clipping occurs at the input volume stage, and although ALC is active, the gain reduction will have no effect on the output clipping. The maximum input that can safely pass through the input volume stage can be calculated by following formula:

$$V_{IN} \leq \frac{V_{DD}}{A_v \text{ (volume gain)}} \quad (1)$$

So in the case of 0 dB volume gain, audio input has to be less than  $V_{DD}$  for both voltage limiter or No clip settings.

When voltage limiter is enabled, ALC can reach its max attenuation for lower voltage limit levels as shown in Figure 58. Typically, after the ALC started working, with 6 dB of audio input change ALC is well within its regulation. Voltage limiter Input headroom can be increased by switching to the LS\_GAIN to 18dB in the Gain Control Register (see Table 8).

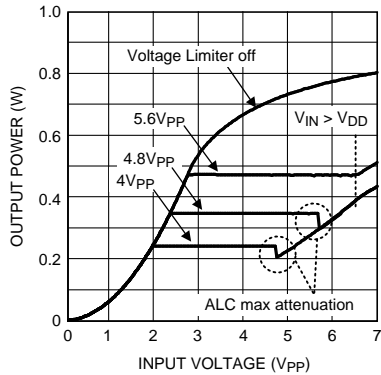

**Figure 58. Voltage Limiter Function**  
 $V_{DD} = 3.3V$ ,  $R_L = 15\mu H + 8\Omega + 15\mu H$   
 $f_{IN} = 1kHz$ ,  $LS\_GAIN = 0$

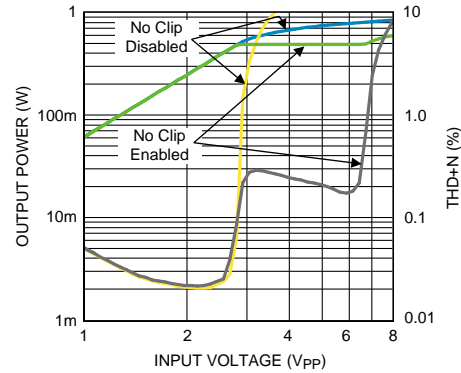

**Figure 59. No Clip Function**  
 $V_{DD} = 3.3V$ ,  $R_L = 15\mu H + 8\Omega + 15\mu H$   
 $f_{IN} = 1kHz$ ,  $LS\_GAIN = 0$   
 Blue, Green = Output Power vs Input Voltage  
 Gray, Yellow = THD+N vs Input Voltage

When No Clip is enabled, class D speaker output reduces when it's about to enter clipping region and power stay constant as long as  $V_{IN}$  is less than  $V_{DD}$  for 0 dB volume gain (see Figure 58). For example, in the case of  $V_{DD} = 3.3V$ , there is a 6 dB of headroom for the change in input. Please see the ALC typical performance curves for additional plots relating to different supply voltages and  $LS\_GAIN$  settings for specific application parameters.

## ATTACK TIME

Attack time ( $t_{ATK}$ ) is the time it takes for the gain to be reduced by 6dB ( $LS\_GAIN=0$ ) once the audio signal exceeds the ALC threshold. Fast attack times allow the ALC to react quickly and prevent transients such as symbol crashes from being distorted. However, fast attack times can lead to volume pumping, where the gain reduction and release becomes noticeable, as the ALC cycles quickly. Slower attack times cause the ALC to ignore the fast transients, and instead act upon longer, louder passages. Selecting an attack time that is too slow can lead to increased distortion in the case of the No Clip function, and possible output overload conditions in the case of the Voltage limiter. The attack time is set by a combination of the value of  $C_{SET}$  and the attack time coefficient as given by Equation 2:

$$t_{ATK} = 20k\Omega C_{SET} / \alpha_{ATK}(s) \quad (2)$$

Where  $\alpha_{ATK}$  is the attack time coefficient (Table 14) set by bits B4:B3 in the Voltage Limit Control Register (see Table 6). The attack time coefficient allows the user to set a nominal attack time. The internal 20k $\Omega$  resistor is subject to temperature change, and it has tolerance between -11% to +20%.

**Table 14. Attack Time Coefficient**

B4	B3	$\alpha_{ATK}$
0	0	2.667
0	1	2
1	0	1.333
1	1	1

## RELEASE TIME

Release time ( $t_{RL}$ ) is the time it takes for the gain to return from 6dB ( $LS\_GAIN=0$ ) to its normal level once the audio signal returns below the ALC threshold. A fast release time allows the ALC to react quickly to transients, preserving the original dynamics of the audio source. However, similar to a fast attack time, a fast release time contributes to volume pumping. A slow release time reduces the effect of volume pumping. The release time is set by a combination of the value of  $C_{SET}$  and release time coefficient as given by Equation 3:

$$t_{RL} = 20M\Omega C_{SET} / \alpha_{RL}(s) \quad (3)$$

where  $\alpha_{RL}$  is the release time coefficient (Table 15) set by bits B4:B3 in the No Clip Control Register. The release time coefficient allows the user to set a nominal release time. The internal 20M $\Omega$  is subject to temperature change, and it has tolerance between -11% to +20%.

**Table 15. Release Time Coefficient**

B4	B3	$\alpha_{RL}$
0	0	2
0	1	2.5
1	0	3
1	1	5

## A-WEIGHTED FILTER

The human ear is sensitive for acoustic signals within a frequency range from about 20Hz to 20kHz. Within this range the sensitivity of the human ear is not equal for each frequency. To approach the hearing response, weighting filters are introduced. One of those filters is the A-weighted filter.

The A-weighted filter is used in signal to noise measurements, where the wanted audio signal is compared to device noise and distortion.

The use of this filter improves the correlation of the measured values to the way these ratios are perceived by the human ear.

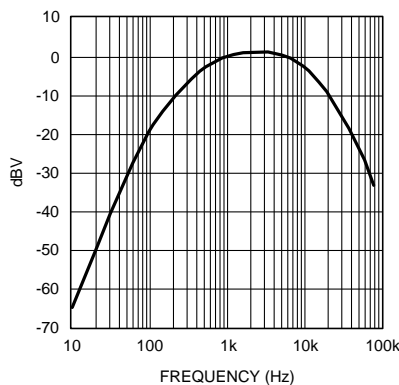

**Figure 60. A-Weighted Filter**

## PROPER SELECTION OF EXTERNAL COMPONENTS

### ALC Timing ( $C_{SET}$ ) Capacitor Selection

The recommended range value of  $C_{SET}$  is between  $.01\mu\text{F}$  to  $1\mu\text{F}$ . Lowering the value below  $.01\mu\text{F}$  can increase the attack time but LM49251 ALC ability to regulate its output can be disrupted and approaches the hard limiter circuit. This in turn increases the THD+N and audio quality will be severely affected.

### Charge Pump Capacitor Selection

Use low ESR ceramic capacitors (less than  $100\text{m}\Omega$ ) for optimum performance.

### Charge Pump Flying Capacitor ( $C_1$ )

The flying capacitor ( $C_1$ ), see [Figure 2](#), affects the load regulation and output impedance of the charge pump. A  $C_1$  value that is too low results in a loss of current drive, leading to a loss of amplifier headroom. A higher valued  $C_1$  improves load regulation and lowers charge pump output impedance to an extent. Above  $2.2\mu\text{F}$ , the  $RDS_{(ON)}$  of the charge pump switches and the ESR of  $C_1$  and  $CPV_{SS}$  dominate the output impedance. A lower value capacitor can be used in systems with low maximum output power requirements.

### Charge Pump Hold Capacitor ( $CPV_{SS}$ )

The value and ESR of the hold capacitor ( $CPV_{SS}$ ) directly affects the ripple on  $CPV_{SS}$  (see [Figure 2](#)). Increasing the value of  $CPV_{SS}$  reduces output ripple. Decreasing the ESR of  $CPV_{SS}$  reduces both output ripple and charge pump output impedance. A lower value capacitor can be used in systems with low maximum output power requirements.

## Input Capacitor Selection

Input capacitors may be required for some applications, or when the audio source is single-ended. Input capacitors block the DC component of the audio signal, eliminating any conflict between the DC component of the audio source and the bias voltage of the LM49251. The input capacitors create a high-pass filter with the input resistors  $R_{IN}$ . The -3dB point of the high-pass filter is found using [Equation 4](#) below.

$$f = 1 / 2\pi R_{IN} C_{IN} (\text{Hz}) \quad (4)$$

Where the value of  $R_{IN}$  is given in the [Electrical Characteristics Table](#).

High-pass filtering the audio signal helps protect the speakers. When the LM49251 is using a single-ended source, power supply noise on the ground is seen as an input signal. Setting the high-pass filter point above the power supply noise frequencies, 217Hz in a GSM phone, for example, filters out the noise such that it is not amplified and heard on the output. Capacitors with a tolerance of 10% or better are recommended for impedance matching and improved CMRR and PSRR.

## Demo Board User Guide

### Quick Start Guide:

1. Connect a shunt across pin 1 and pin 2 of JUI to provide 3.3V to  $I^2C_{V_{DD}}$ .
2. Connect a shunt across JU3 to provide 1.8V to  $V_{DDHP}$  from on board regulator.
3. Connect a 4Ω or 8Ω speaker across LSOUTL (left loudspeaker output) and LSOUTR (right loudspeaker output).
4. Connect stereo headphones to the headphone jack J1.
5. Connect a 3.6V power supply to the  $V_{DD}$  pin of J3 and the ground source to the GND pin.
6. Apply audio input signal to any of the stereo (IN1/IN2) or mono (MONO\_IN) inputs.
7. Turn on power supply.
8. Connect the mini USB cable to J29 and the other end of the cable to a PC.
9. Open the LM49251 I<sup>2</sup>C control software.
10. Verify that the device has been acknowledged by looking at bottom left corner of GUI (see [Figure 61](#) and [Figure 62](#)).
11. On GUI:
  - a. Set POWER: on
  - b. Set MODE SELECT to desired position (see [Table 16](#)).
  - c. Set all VOLUME CONTROL to 0dB by clicking on Set 0dB button.

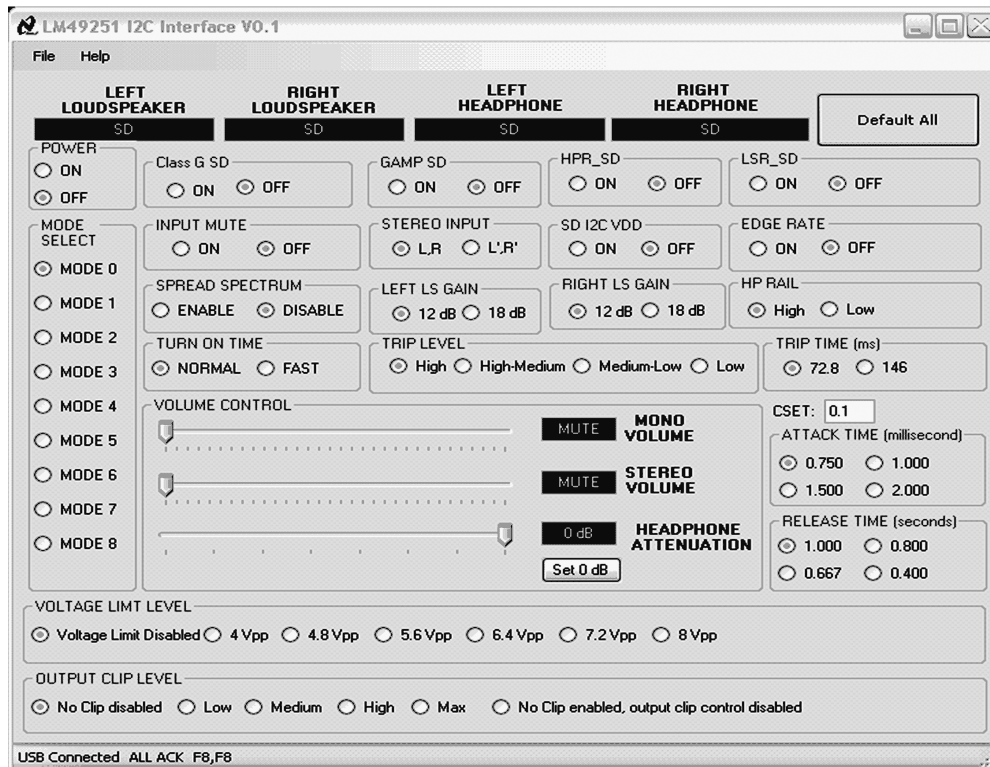

Figure 61. Software Graphic user Interface (GUI)

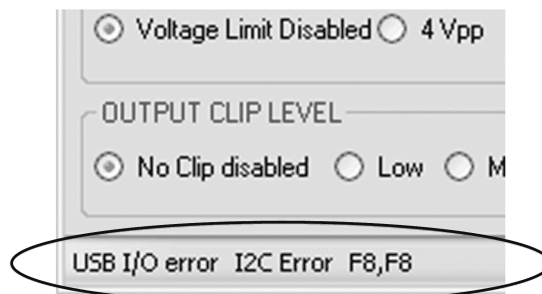

Figure 62. Error Message displayed on GUI if device is NOT acknowledged (I<sup>2</sup>C Error) or if there is an USB error (USB I/O error)

Table 16. Mode Table

SPK(L)	SPK(R)	HP(L)	HP(R)	Datasheet
SD	SD	SD	SD	Mode 0
G <sub>ST</sub> X (L + R)	G <sub>ST</sub> X (L + R)	SD	SD	Mode 1
G <sub>ST</sub> X L	G <sub>ST</sub> X R	SD	SD	Mode 2
G <sub>M</sub> X M	G <sub>M</sub> X M	SD	SD	Mode 3
SD	SD	G <sub>M</sub> X M	G <sub>M</sub> X M	Mode 4
G <sub>M</sub> X M	G <sub>M</sub> X M	G <sub>M</sub> X M	G <sub>M</sub> X M	Mode 5
SD	SD	G <sub>ST</sub> X L	G <sub>ST</sub> X R	Mode 6
G <sub>ST</sub> X (L + R)	G <sub>ST</sub> X (L + R)	G <sub>ST</sub> X L	G <sub>ST</sub> X R	Mode 7
G <sub>ST</sub> X L	G <sub>ST</sub> X R	G <sub>ST</sub> X L	G <sub>ST</sub> X R	Mode 8

**Table 17. Board Connectors**

Designator	Function	Comments
J1	(HPOUT) Headphone Output	Ring - Right Channel, Tip - Left Channel
J3	(V <sub>DD</sub> /GND) Loudspeaker Power Supply	
J4	(V <sub>DD</sub> HP/GND) Headphone Power Supply	Apply voltage on J4 when JU3 is open. DO NOT apply voltage if JU3 is closed
J29	Mini USB	
JU1	I <sup>2</sup> CV <sub>DD</sub> Select	Pin 1 = 3.3V, Pin 2 = I <sup>2</sup> CV <sub>DD</sub> , Pin 3 = GND Short Pin 1 and Pin 2 for I <sup>2</sup> CV <sub>DD</sub> = 3.3V
JU2	(HPOUT) Headphone Output	Left and Right Channel
JU3	V <sub>DD</sub> HP = 1.8V	Short JU3 for V <sub>DD</sub> HP = 1.8V from on board regulator
JU4	5V	Access to 5V from USB
JU6	I <sup>2</sup> C Clock/Data	GND, SDA, SCL connections
JU7		To program USB controller
LSOUTL	Left Loudspeaker Out	
LSOUTR	Right Loudspeaker Out	
MONO_IN	Mono Input	
IN1	Stereo Input 1	
IN2	Stereo Input 2	

**Bill of Materials****Table 18. Bill of Materials**

Ref Designator	Part Description	Manufacturer	Part Number
	LM49251TL DEMO BOARD PCB, RevA	TI	
U1	LM49251TL	TI	LM49251TL
U2	USB, 25 MIPS, 16 kB Flash, 10-Bit ADC, 32-Pin Mixed-Signal MCU	Silicon Labs	C8051F320-GQ
U3	Ultra Low Noise, 150mA Linear Regulator for RF/Analog Circuits Requires No Bypass Capacitor	TI	LP5900TL-1.8/NOPB
C12, C13, C14, C39, C40	CAP CER 4.7UF 10V X5R 0603 10%	Taiyo Yuden	LMK107BJ475KA-T
C10, C38, C41	CAP .1UF 25V CERAMIC X7R 0603 5%	Kemet	C0603C104J3RACTU
R3	NO LOAD	NO LOAD	NO LOAD
C11, C9, C15, C8, C7	CAP CER 2.2UF 10V X7R 0603 10%	Murata	GRM188R71A225KE15D
L1, L2	FERRITE CHIP 30 OHM 2200MA 0402	Murata	BLM15PD300SN1D
C22, C37	CAP CERM .47UF 16V X7R 0603 10%	Kemet	C0603C474K4RACTU
C1, C2, C3, C4, C5, C6	CAP CER .22UF 10V 10% X7R 0603	Murata	GRM188R71A224KA01D
R1, R2 R4, R5	RES 10.0K OHM 1/10W 1% 0603 SMD	Panasonic	ERJ-3EKF1002V
J29	CONN RECEPT MINI USB2.0 5POS	Hirose	UX60-MB-5ST
JU1, JU6, JU7	CONN HEADR BRKWAY .100 03POS STR	Tyco	9-146285-0-03
J3, J4, JU2, LSOUTL, LSOUTR, Jw	CONN HEADR BRKWAY .100 02POS STR	Tyco	9-146285-0-02
Mono_IN, In, In1	CONN HDR BRKWAY .100 04POS VERT	Tyco	9-146282-0-04
J1	CONN JACK STEREO 3.5MM HORIZONTAL	Switchcraft	35RAPC4BH3
JU3, JU7, JU1,	Jumper Shunt w/handle, 30µin gold plated, 0.100in pitch	Tyco/AMP	881545-2

Demo Board Schematic Diagram

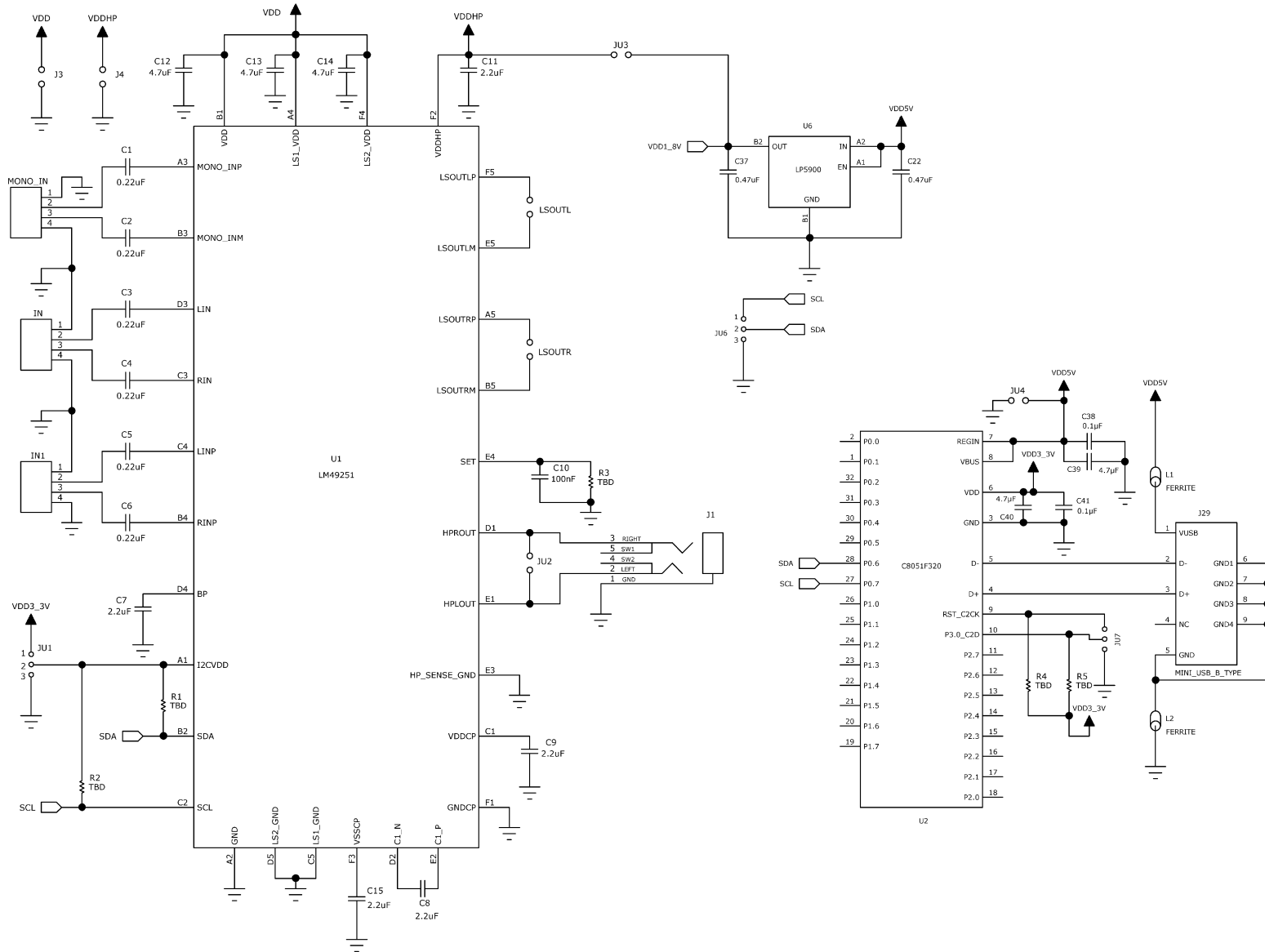

**Demo Board Layout**

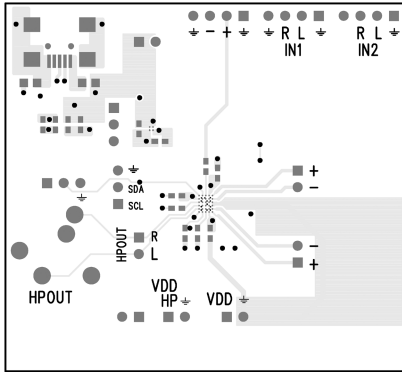

**Figure 63. Top Layer**



**Figure 64. Layer 2**

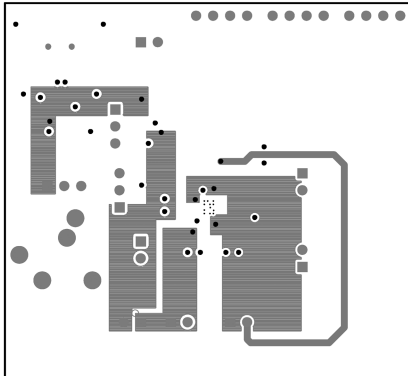

**Figure 65. Layer 3**

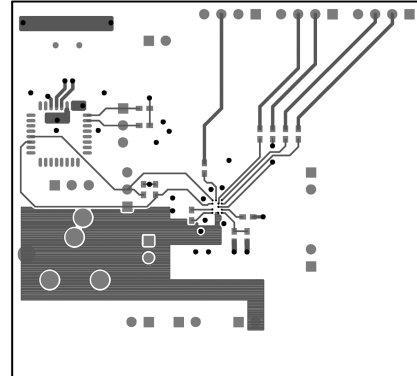

**Figure 66. Bottom Layer**

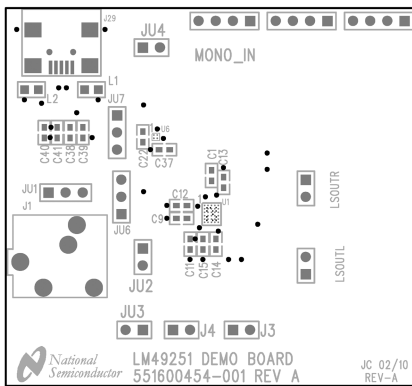

**Figure 67. Top Silkscreen**

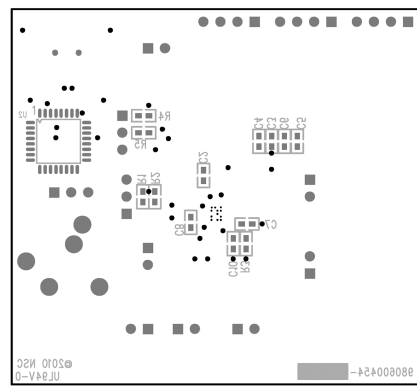

**Figure 68. Bottom Silkscreen**

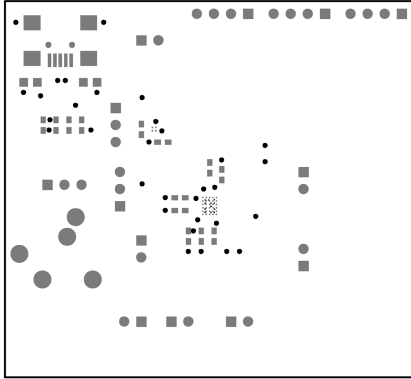

Figure 69. Paste Mask Top Layer



Figure 70. Past Mask Bottom Layer

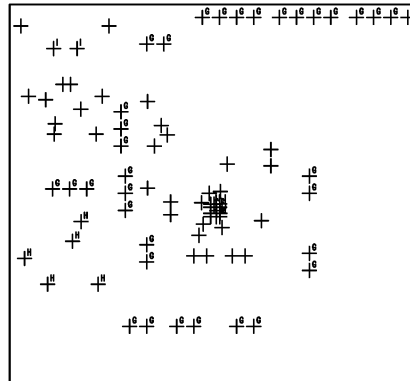

Figure 71. Drill Drawing

**Revision History**

<b>Rev</b>	<b>Date</b>	<b>Description</b>
1.0	02/08/11	Initial Web released.
A	04/05/13	Changed layout of National Data Sheet to TI format

**PACKAGING INFORMATION**

Orderable Device	Status (1)	Package Type	Package Drawing	Pins	Package Qty	Eco Plan (2)	Lead finish/ Ball material (6)	MSL Peak Temp (3)	Op Temp (°C)	Device Marking (4/5)	Samples
LM49251TL/NOPB	ACTIVE	DSBGA	YZR	30	250	RoHS & Green	SNAGCU	Level-1-260C-UNLIM	-40 to 85	GN9	<b>Samples</b>
LM49251TLX/NOPB	ACTIVE	DSBGA	YZR	30	3000	RoHS & Green	SNAGCU	Level-1-260C-UNLIM	-40 to 85	GN9	<b>Samples</b>

(1) The marketing status values are defined as follows:

**ACTIVE:** Product device recommended for new designs.

**LIFEBUY:** TI has announced that the device will be discontinued, and a lifetime-buy period is in effect.

**NRND:** Not recommended for new designs. Device is in production to support existing customers, but TI does not recommend using this part in a new design.

**PREVIEW:** Device has been announced but is not in production. Samples may or may not be available.

**OBSOLETE:** TI has discontinued the production of the device.

(2) **RoHS:** TI defines "RoHS" to mean semiconductor products that are compliant with the current EU RoHS requirements for all 10 RoHS substances, including the requirement that RoHS substance do not exceed 0.1% by weight in homogeneous materials. Where designed to be soldered at high temperatures, "RoHS" products are suitable for use in specified lead-free processes. TI may reference these types of products as "Pb-Free".

**RoHS Exempt:** TI defines "RoHS Exempt" to mean products that contain lead but are compliant with EU RoHS pursuant to a specific EU RoHS exemption.

**Green:** TI defines "Green" to mean the content of Chlorine (Cl) and Bromine (Br) based flame retardants meet JS709B low halogen requirements of <=1000ppm threshold. Antimony trioxide based flame retardants must also meet the <=1000ppm threshold requirement.

(3) MSL, Peak Temp. - The Moisture Sensitivity Level rating according to the JEDEC industry standard classifications, and peak solder temperature.

(4) There may be additional marking, which relates to the logo, the lot trace code information, or the environmental category on the device.

(5) Multiple Device Markings will be inside parentheses. Only one Device Marking contained in parentheses and separated by a "~" will appear on a device. If a line is indented then it is a continuation of the previous line and the two combined represent the entire Device Marking for that device.

(6) Lead finish/Ball material - Orderable Devices may have multiple material finish options. Finish options are separated by a vertical ruled line. Lead finish/Ball material values may wrap to two lines if the finish value exceeds the maximum column width.

**Important Information and Disclaimer:**The information provided on this page represents TI's knowledge and belief as of the date that it is provided. TI bases its knowledge and belief on information provided by third parties, and makes no representation or warranty as to the accuracy of such information. Efforts are underway to better integrate information from third parties. TI has taken and continues to take reasonable steps to provide representative and accurate information but may not have conducted destructive testing or chemical analysis on incoming materials and chemicals. TI and TI suppliers consider certain information to be proprietary, and thus CAS numbers and other limited information may not be available for release.

In no event shall TI's liability arising out of such information exceed the total purchase price of the TI part(s) at issue in this document sold by TI to Customer on an annual basis.

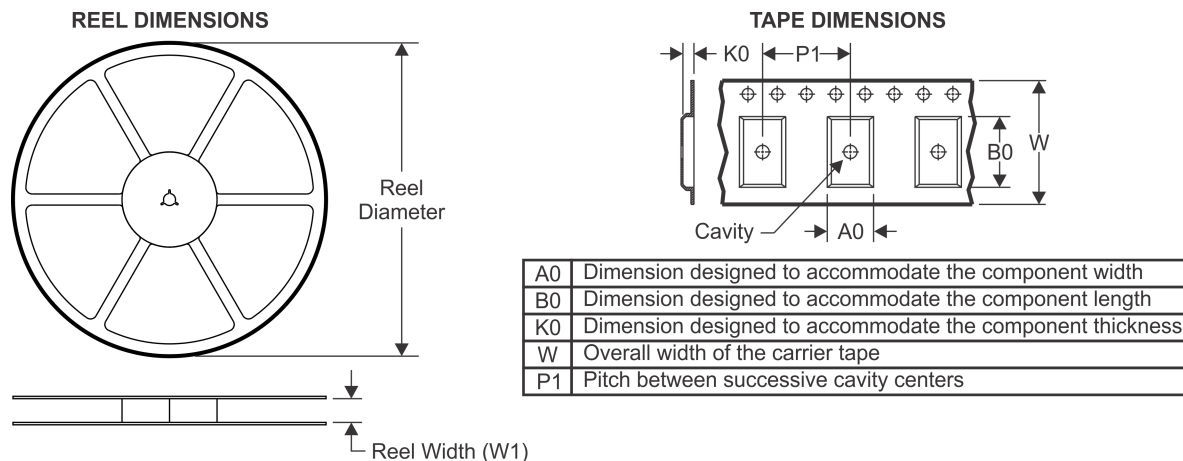
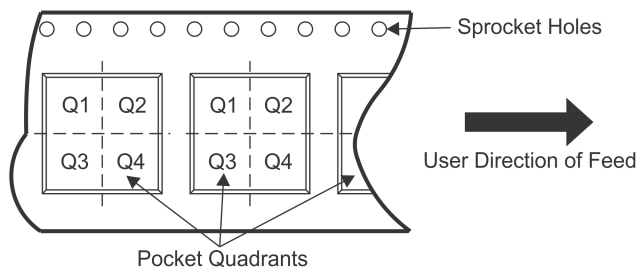

**TAPE AND REEL INFORMATION**

**QUADRANT ASSIGNMENTS FOR PIN 1 ORIENTATION IN TAPE**

\*All dimensions are nominal

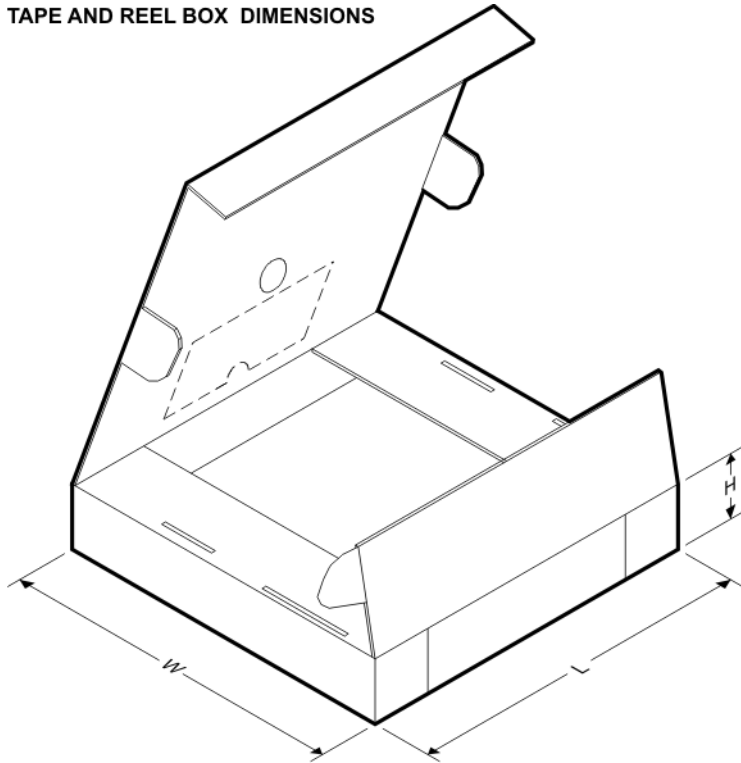
Device	Package Type	Package Drawing	Pins	SPQ	Reel Diameter (mm)	Reel Width W1 (mm)	A0 (mm)	B0 (mm)	K0 (mm)	P1 (mm)	W (mm)	Pin1 Quadrant
LM49251TL/NOPB	DSBGA	YZR	30	250	178.0	8.4	2.74	3.15	0.76	4.0	8.0	Q1
LM49251TLX/NOPB	DSBGA	YZR	30	3000	178.0	8.4	2.74	3.15	0.76	4.0	8.0	Q1

**TAPE AND REEL BOX DIMENSIONS**

\*All dimensions are nominal

Device	Package Type	Package Drawing	Pins	SPQ	Length (mm)	Width (mm)	Height (mm)
LM49251TL/NOPB	DSBGA	YZR	30	250	208.0	191.0	35.0
LM49251TLX/NOPB	DSBGA	YZR	30	3000	208.0	191.0	35.0



## IMPORTANT NOTICE AND DISCLAIMER

TI PROVIDES TECHNICAL AND RELIABILITY DATA (INCLUDING DATA SHEETS), DESIGN RESOURCES (INCLUDING REFERENCE DESIGNS), APPLICATION OR OTHER DESIGN ADVICE, WEB TOOLS, SAFETY INFORMATION, AND OTHER RESOURCES "AS IS" AND WITH ALL FAULTS, AND DISCLAIMS ALL WARRANTIES, EXPRESS AND IMPLIED, INCLUDING WITHOUT LIMITATION ANY IMPLIED WARRANTIES OF MERCHANTABILITY, FITNESS FOR A PARTICULAR PURPOSE OR NON-INFRINGEMENT OF THIRD PARTY INTELLECTUAL PROPERTY RIGHTS.

These resources are intended for skilled developers designing with TI products. You are solely responsible for (1) selecting the appropriate TI products for your application, (2) designing, validating and testing your application, and (3) ensuring your application meets applicable standards, and any other safety, security, regulatory or other requirements.

These resources are subject to change without notice. TI grants you permission to use these resources only for development of an application that uses the TI products described in the resource. Other reproduction and display of these resources is prohibited. No license is granted to any other TI intellectual property right or to any third party intellectual property right. TI disclaims responsibility for, and you will fully indemnify TI and its representatives against, any claims, damages, costs, losses, and liabilities arising out of your use of these resources.

TI's products are provided subject to [TI's Terms of Sale](#) or other applicable terms available either on [ti.com](http://ti.com) or provided in conjunction with such TI products. TI's provision of these resources does not expand or otherwise alter TI's applicable warranties or warranty disclaimers for TI products.

TI objects to and rejects any additional or different terms you may have proposed.

Mailing Address: Texas Instruments, Post Office Box 655303, Dallas, Texas 75265  
Copyright © 2021, Texas Instruments Incorporated