

## TL331B、TL391B 和 TL331 单路比较器

### 1 特性

- 新增了 **TL331B** 和 **TL391B**
- 改进了 B 版本的规格
  - 最大额定值：高达 38V
  - ESD 等级 (HBM)：2kV
  - 提高了反向电压性能
  - 低输入失调电压：0.37mV
  - 低输入偏置电流：3.5nA
  - 低电源电流：430μA
  - 更短的响应时间 (1μsec)
  - **TL391B** 提供了 **替代引脚排列**
- TL331B 是经改进的 TL331 直接替代产品
- 共模输入电压范围包括接地
- 差分输入电压范围等于最大额定电源电压：±38V
- 低输出饱和电压
- 输出与 TTL、MOS 和 CMOS 兼容

### 2 应用

- [扫地机器人](#)
- [单相 UPS](#)
- [服务器 PSU](#)
- [无线电动工具](#)
- [无线基础设施](#)
- [电器](#)
- [楼宇自动化](#)
- [工厂自动化与控制](#)
- [电机驱动器](#)
- [信息娱乐系统与仪表组](#)

### 3 说明

**TL331B** 和 **TL391B** 器件是业界通用 **TL331** 比较器的下一代版本。下一代器件为成本敏感型应用提供了卓越的价值，其特性包括更低的失调电压、更高的电源电压能力、更低的电源电流、更低的输入偏置电流、更低的传播延迟、更宽的温度范围以及更高的 2kV ESD 性能，并提供了直接替代的便利性。**TL331B** 是经改进的 **TL331I** 和 **TL331K** 版本直接替代产品，而 **TL391B** 可提供 **TL331B** 的 **替代引脚排列**，以替代同类竞争器件。

如果两个电源的电压差处于 2V 至 36V 范围内且 VCC 比输入共模电压至少高 1.5V，那么也可以使用双电源。漏极电流不受电源电压的影响。可将输出连接到其它集电极开路输出，以实现有线 AND 关联。

#### 器件信息

器件型号 <sup>(1)</sup>	封装	封装尺寸 (标称值)
TL331、 TL331B、 TL391B	SOT-23 (5)	2.90mm × 1.60mm

(1) 如需了解所有可用封装，请参阅数据表末尾的可订购产品附录

#### 系列比较表

规格	<b>TL331B</b> <b>TL391B</b>	<b>TL331I</b>	<b>TL331K</b>	单位
电源电压	2 至 36	2 至 36	2 至 36	V
总电源电流 (5V 至 36V 最大值)	0.43	0.7	0.7	mA
温度范围	-40 至 125	-40 至 85	-40 至 105	°C
ESD (HBM)	2000	1000	1000	V
失调电压 (整个温度范围内的最大值)	± 4	± 9	± 9	mV
输入偏置电流 (典型值/最大值)	3.5/25	25/250	25/250	nA
响应时间 (典型值)	1	1.3	1.3	μsec



## Table of Contents

<b>1 特性</b> .....	1	<b>7 Detailed Description</b> .....	15
<b>2 应用</b> .....	1	7.1 Overview.....	15
<b>3 说明</b> .....	1	7.2 Functional Block Diagram.....	15
<b>4 Revision History</b> .....	2	7.3 Feature Description.....	15
<b>5 Pin Configuration and Functions</b> .....	3	7.4 Device Functional Modes.....	15
Pin Functions.....	3	<b>8 Application and Implementation</b> .....	16
<b>6 Specifications</b> .....	4	8.1 Application Information.....	16
6.1 Absolute Maximum Ratings, TL331 and TL331K.....	4	8.2 Typical Application.....	16
6.2 Absolute Maximum Ratings, TL331B and TL391B.....	4	<b>9 Power Supply Recommendations</b> .....	18
6.3 ESD Ratings, TL331 and TL331K.....	5	<b>10 Layout</b> .....	18
6.4 ESD Ratings, TL331B and TL391B.....	5	10.1 Layout Guidelines.....	18
6.5 Recommended Operating Conditions, TL331 and TL331K.....	5	10.2 Layout Example.....	18
6.6 Recommended Operating Conditions, TL331B and TL391B.....	5	<b>11 Device and Documentation Support</b> .....	19
6.7 Thermal Information.....	5	11.1 Documentation Support.....	19
6.8 Electrical Characteristics, TL331B and TL391B.....	6	11.2 Receiving Notification of Documentation Updates..	19
6.9 Switching Characteristics, TL331B and TL391B.....	6	11.3 Support Resources.....	19
6.10 Electrical Characteristics, TL331 and TL331K.....	7	11.4 Trademarks.....	19
6.11 Switching Characteristics, TL331 and TL331K.....	7	11.5 Electrostatic Discharge Caution.....	19
6.12 Typical Characteristics, TL331 and TL331K.....	8	11.6 Glossary.....	19
6.13 Typical Characteristics, TL331B and TL391B.....	9	<b>12 Mechanical, Packaging, and Orderable Information</b> .....	19

## 4 Revision History

注：以前版本的页码可能与当前版本的页码不同

### Changes from Revision I (August 2020) to Revision J (November 2020) Page

• 通篇将 TL331B 和 TL391B 最小建议电源电压更改为 2V.....	1
• 更正了系列比较表中“B”、“K”和“L”版本的电源电压.....	1
• Updated Supply Voltage vs Supply Current Typical Graph for 2V.....	9

### Changes from Revision H (April 2020) to Revision I (August 2020) Page

• 更新了整个文档的表、图和交叉参考的编号格式.....	1
• Added "B" device Typical Char graphs.....	9

### Changes from Revision G (January 2015) to Revision H (April 2020) Page

• 添加了 TL331B 和 TL391B 表和引脚排列，更新了 APL 的新增 B 器件的首页.....	1
• Added Input current, $I_{IK}$ in <i>Absolute Maximum Ratings</i> .....	4
• Changed incorrect TL331 and TL331K Temp Ranges in <i>Recommended Operating Conditions</i> .....	5
• Changed text from: open-drain output to: open-collector output .....	15
• Removed sentence: This enables much head room for modern day supplies of 3.3 V and 5.0 V. ....	15
• Changed the text 'The output NPN will sink current when the positive input voltage is higher than the negative input voltage and the offset voltage' to 'The output NPN will sink current when the negative input voltage is higher than the positive input voltage and the offset voltage.'.....	15
• Changed Output Current specifications from: to: in <i>Design Parameters</i> .....	16
• Changed first paragraph of the <i>Response Time</i> section .....	17
• Added <i>Receiving Notification of Documentation Updates</i> section and <i>Community Resources</i> section.....	19

## 5 Pin Configuration and Functions

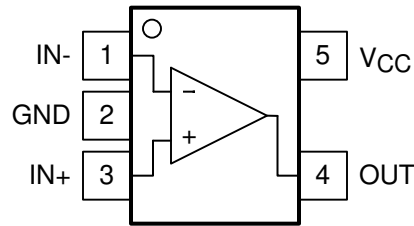

Note reversed inputs compared to similar common pinout

图 5-1. TL331, TL331B DBV Package, 5-Pin SOT-23, Top View

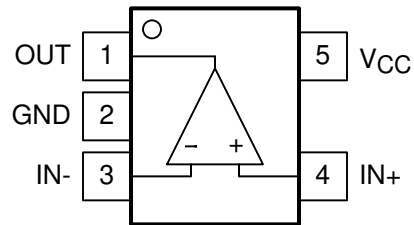

Note reversed inputs compared to similar common pinout

图 5-2. TL391B DBV Package, 5-Pin SOT-23, Top View

## Pin Functions

NAME	PIN		TYPE	DESCRIPTION
	TL331, TL331B NO.	TL391B NO.		
IN+	3	4	I	Positive Input
IN -	1	3	I	Negative Input
OUT	4	1	O	Open Collector/Drain Output
V <sub>CC</sub>	5	5	—	Power Supply Input
GND	2	2	—	Ground

## 6 Specifications

### 6.1 Absolute Maximum Ratings, TL331 and TL331K

over operating free-air temperature range (unless otherwise noted)<sup>(1)</sup>

		MIN	MAX	UNIT
V <sub>CC</sub>	Supply voltage <sup>(2)</sup>	0	36	V
V <sub>ID</sub>	Differential input voltage <sup>(3)</sup>	- 36	36	V
V <sub>I</sub>	Input voltage range (either input)	- 0.3	36	V
V <sub>O</sub>	Output voltage	0	36	V
I <sub>O</sub>	Output current	0	20	mA
	Duration of output short-circuit to ground <sup>(4)</sup>	Unlimited		
I <sub>IK</sub>	Input current <sup>(5)</sup>		- 50	mA
T <sub>J</sub>	Operating virtual junction temperature	- 40	150	°C
T <sub>stg</sub>	Storage temperature	- 65	150	°C

- (1) Stresses beyond those listed under *Absolute Maximum Ratings* may cause permanent damage to the device. These are stress ratings only, which do not imply functional operation of the device at these or any other conditions beyond those indicated under *Recommended Operating Conditions*. Exposure to absolute-maximum-rated conditions for extended periods may affect device reliability.
- (2) All voltage values, except differential voltages, are with respect to the network ground.
- (3) Differential voltages are at IN+ with respect to IN - .
- (4) Short circuits from outputs to V<sub>CC</sub> can cause excessive heating and eventual destruction.
- (5) Input current flows thorough parasitic diode to ground and will turn on parasitic transistors that will increase ICC and may cause output to be incorrect. Normal operation resumes when input current is removed.

### 6.2 Absolute Maximum Ratings, TL331B and TL391B

over operating free-air temperature range (unless otherwise noted)<sup>(1)</sup>

		MIN	MAX	UNIT
V <sub>CC</sub>	Supply voltage <sup>(2)</sup>	-0.3	38	V
V <sub>ID</sub>	Differential input voltage <sup>(3)</sup>	- 38	38	V
V <sub>I</sub>	Input voltage range (either input)	- 0.3	38	V
V <sub>O</sub>	Output voltage	-0.3	38	V
I <sub>O</sub>	Output current		20	mA
	Duration of output short-circuit to ground <sup>(4)</sup>	Unlimited		
I <sub>IK</sub>	Input current <sup>(5)</sup>		- 50	mA
T <sub>J</sub>	Operating virtual junction temperature	- 40	150	°C
T <sub>stg</sub>	Storage temperature	- 65	150	°C

- (1) Stresses beyond those listed under *Absolute Maximum Ratings* may cause permanent damage to the device. These are stress ratings only, which do not imply functional operation of the device at these or any other conditions beyond those indicated under *Recommended Operating Conditions*. Exposure to absolute-maximum-rated conditions for extended periods may affect device reliability.
- (2) All voltage values, except differential voltages, are with respect to the network ground.
- (3) Differential voltages are at IN+ with respect to IN - .
- (4) Short circuits from outputs to V<sub>CC</sub> can cause excessive heating and eventual destruction.
- (5) Input current flows thorough parasitic diode to ground and will turn on parasitic transistors that will increase ICC and may cause output to be incorrect. Normal operation resumes when input current is removed.

### 6.3 ESD Ratings, TL331 and TL331K

		VALUE	UNIT
V <sub>(ESD)</sub>	Electrostatic discharge	Human body model (HBM), per ANSI/ESDA/JEDEC JS-001 <sup>(1)</sup>	±1000
		Charged device model (CDM), per JEDEC specification JESD22-C101 <sup>(2)</sup>	±750

- (1) JEDEC document JEP155 states that 500-V HBM allows safe manufacturing with a standard ESD control process.  
 (2) JEDEC document JEP157 states that 250-V CDM allows safe manufacturing with a standard ESD control process.

### 6.4 ESD Ratings, TL331B and TL391B

		VALUE	UNIT
V <sub>(ESD)</sub>	Electrostatic discharge	Human body model (HBM), per ANSI/ESDA/JEDEC JS-001 <sup>(1)</sup>	±2000
		Charged device model (CDM), per JEDEC specification JESD22-C101 <sup>(2)</sup>	±750

- (1) JEDEC document JEP155 states that 500-V HBM allows safe manufacturing with a standard ESD control process.  
 (2) JEDEC document JEP157 states that 250-V CDM allows safe manufacturing with a standard ESD control process.

### 6.5 Recommended Operating Conditions, TL331 and TL331K

over operating free-air temperature range (unless otherwise noted)

		MIN	MAX	UNIT
V <sub>CC</sub>	Supply voltage	2	36	V
T <sub>J</sub>	Junction temperature, TL331	- 40	85	°C
T <sub>J</sub>	Junction temperature, TL331K	- 40	105	°C

### 6.6 Recommended Operating Conditions, TL331B and TL391B

over operating free-air temperature range (unless otherwise noted)

		MIN	MAX	UNIT
V <sub>CC</sub>	Supply voltage	2	36	V
T <sub>J</sub>	Junction temperature	- 40	125	°C

### 6.7 Thermal Information

THERMAL METRIC <sup>(1)</sup>		TL331, TL331K	TL331B, TL391B	UNIT
		DBV (SOT-23)	DBV (SOT-23)	
		5 PINS	5 PINS	
R <sub>θJA</sub>	Junction-to-ambient thermal resistance	218.3	211.7	°C/W
R <sub>θJC(top)</sub>	Junction-to-case (top) thermal resistance	87.3	133.6	°C/W
R <sub>θJB</sub>	Junction-to-board thermal resistance	44.9	79.9	°C/W
ψ <sub>JT</sub>	Junction-to-top characterization parameter	4.3	56.4	°C/W
ψ <sub>JB</sub>	Junction-to-board characterization parameter	44.1	79.6	°C/W

- (1) For more information about traditional and new thermal metrics, see the [Semiconductor and IC Package Thermal Metrics](#) application report.

## 6.8 Electrical Characteristics, TL331B and TL391B

$V_S = 5\text{ V}$ ,  $V_{CM} = (V -)$ ;  $T_A = 25^\circ\text{C}$  (unless otherwise noted).

PARAMETER		TEST CONDITIONS	MIN	TYP	MAX	UNIT
$V_{IO}$	Input offset voltage	$V_S = 5$ to $36\text{V}$	- 2.5	$\pm 0.37$	2.5	mV
		$V_S = 5$ to $36\text{V}$ , $T_A = -40^\circ\text{C}$ to $+125^\circ\text{C}$	- 4		4	
$I_B$	Input bias current			- 3.5	- 25	nA
		$T_A = -40^\circ\text{C}$ to $+125^\circ\text{C}$			- 50	nA
$I_{OS}$	Input offset current		- 10	$\pm 0.5$	10	nA
		$T_A = -40^\circ\text{C}$ to $+125^\circ\text{C}$	- 25		25	nA
$V_{CM}$	Input voltage range	$V_S = 3$ to $36\text{V}$	$(V -) - 0.1$		$(V+) - 1.5$	V
		$V_S = 3$ to $36\text{V}$ , $T_A = -40^\circ\text{C}$ to $+125^\circ\text{C}$	$(V -) - 0.05$		$(V+) - 2.0$	V
$A_{VD}$	Large signal differential voltage amplification	$V_S = 15\text{V}$ , $V_O = 1.4\text{V}$ to $11.4\text{V}$ ; $R_L \geq 15\text{k}$ to $(V+)$	50	200		V/mV
$V_{OL}$	Low level output Voltage {swing from $(V -)$ }	$I_{SINK} \leq 4\text{mA}$ , $V_{ID} = -1\text{V}$		110	400	mV
		$I_{SINK} \leq 4\text{mA}$ , $V_{ID} = -1\text{V}$ $T_A = -40^\circ\text{C}$ to $+125^\circ\text{C}$			550	mV
$I_{OH-LKG}$	High-level output leakage current	$(V+) = V_O = 5\text{V}$ ; $V_{ID} = 1\text{V}$		0.1	20	nA
$I_{OH-LKG}$	High-level output leakage current	$(V+) = V_O = 36\text{V}$ ; $V_{ID} = 1\text{V}$ ; $T_A = -40^\circ\text{C}$ to $+125^\circ\text{C}$			1000	nA
$I_{OL}$	Low level output current	$V_{OL} = 1.5\text{V}$ ; $V_{ID} = -1\text{V}$ ; $V_S = 5\text{V}$	6	18		mA
$I_Q$	Quiescent current	$V_S = 5\text{V}$ , no load		210	330	$\mu\text{A}$
		$V_S = 36\text{V}$ , no load, $T_A = -40^\circ\text{C}$ to $+125^\circ\text{C}$		275	430	$\mu\text{A}$

## 6.9 Switching Characteristics, TL331B and TL391B

$V_S = 5\text{V}$ ,  $V_{O\_PULLUP} = 5\text{V}$ ,  $V_{CM} = V_S/2$ ,  $C_L = 15\text{pF}$ ,  $R_L = 5.1\text{k}\ \Omega$ ,  $T_A = 25^\circ\text{C}$  (unless otherwise noted).

PARAMETER		TEST CONDITIONS	MIN	TYP	MAX	UNIT
$t_{\text{response}}$	Propagation delay time, high-to-low; Small scale input signal <sup>(1)</sup>	Input overdrive = $5\text{mV}$ , Input step = $100\text{mV}$		1000		ns
$t_{\text{response}}$	Propagation delay time, high-to-low; TTL input signal <sup>(1)</sup>	TTL input with $V_{\text{ref}} = 1.4\text{V}$		300		ns

(1) High-to-low and low-to-high refers to the transition at the input.

## 6.10 Electrical Characteristics, TL331 and TL331K

at specified free-air temperature,  $V_{CC} = 5\text{ V}$  (unless otherwise noted)

PARAMETER	TEST CONDITIONS <sup>(1)</sup>	$T_A$ <sup>(3)</sup>	MIN	TYP	MAX	UNIT
$V_{IO}$ Input offset voltage	$V_{CC} = 5\text{ V to } 30\text{ V}$ , $V_O = 1.4\text{ V}$ , $V_{IC} = V_{IC(min)}$	25°C		2	5	mV
		Full range			9	
$I_{IO}$ Input offset current	$V_O = 1.4\text{ V}$	25°C		5	50	nA
		Full range			250	
$I_{IB}$ Input bias current	$V_O = 1.4\text{ V}$	25°C		- 25	- 250	nA
		Full range			- 400	
$V_{ICR}$ Common-mode input voltage range <sup>(2)</sup>		Full range	0 to $V_{CC} - 1.5$			V
$A_{VD}$ Large-signal differential voltage amplification	$V_{CC} = 15\text{ V}$ , $V_O = 1.4\text{ V to } 11.4\text{ V}$ , $R_L \geq 15\text{ k}\Omega$ to $V_{CC}$	25°C	50	200		V/mV
$I_{OH}$ High-level output current	$V_{OH} = 5\text{ V}$ , $V_{ID} = 1\text{ V}$	25°C		0.1	50	nA
	$V_{OH} = 30\text{ V}$ , $V_{ID} = 1\text{ V}$	Full range			1	$\mu\text{ A}$
$V_{OL}$ Low-level output voltage	$I_{OL} = 4\text{ mA}$ , $V_{ID} = - 1\text{ V}$	25°C		150	400	mV
		Full range			700	
$I_{OL}$ Low-level output current	$V_{OL} = 1.5\text{ V}$ , $V_{ID} = - 1\text{ V}$	25°C	6			mA
$I_{CC}$ Supply current	$R_L = \infty$ , $V_{CC} = 5\text{ V}$	25°C		0.4	0.7	mA

- (1) All characteristics are measured with zero common-mode input voltage, unless otherwise specified.
- (2) The voltage at either input or common-mode should not be allowed to go negative by more than 0.3 V. The upper end of the common-mode voltage range is  $V_{CC+} - 1.5\text{ V}$ , but either or both inputs can go to 30 V without damage.
- (3) Full range  $T_A$  is  $- 40^\circ\text{C}$  to  $+85^\circ\text{C}$  for I-suffix devices and  $- 40^\circ\text{C}$  to  $+105^\circ\text{C}$  for K-suffix devices.

## 6.11 Switching Characteristics, TL331 and TL331K

$V_{CC} = 5\text{ V}$ ,  $T_A = 25^\circ\text{C}$

PARAMETER	TEST CONDITIONS	TYP	UNIT	
Response time	$R_L$ connected to 5 V through 5.1 k $\Omega$ , $C_L = 15\text{ pF}$ <sup>(1) (2)</sup>	100-mV input step with 5-mV overdrive	1.3	$\mu\text{ s}$
		TTL-level input step	0.3	

- (1)  $C_L$  includes probe and jig capacitance.
- (2) The response time specified is the interval between the input step function and the instant when the output crosses 1.4 V.

## 6.12 Typical Characteristics, TL331 and TL331K



图 6-1. Supply Current vs Supply Voltage



图 6-2. Input Bias Current vs Supply Voltage

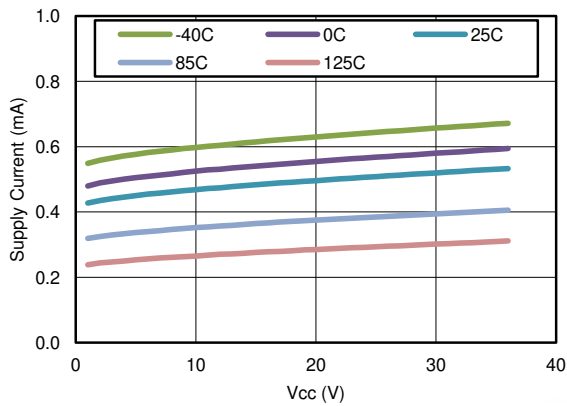

图 6-3. Output Low Voltage vs Output Current ( $I_{OL}$ )

### 6.13 Typical Characteristics, TL331B and TL391B

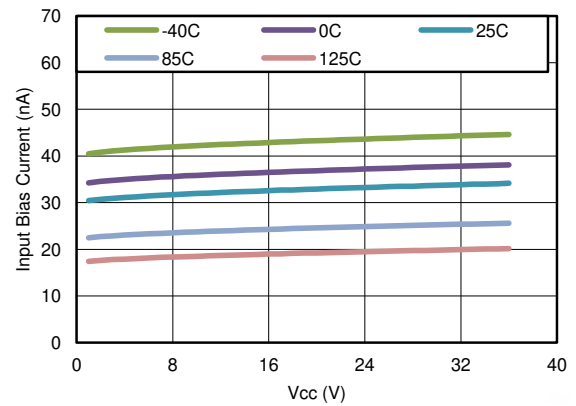
$T_A = 25^\circ\text{C}$ ,  $V_S = 5\text{ V}$ ,  $R_{\text{PULLUP}} = 5.1\text{ k}$ ,  $C_L = 15\text{ pF}$ ,  $V_{\text{CM}} = 0\text{ V}$ ,  $V_{\text{UNDERDRIVE}} = 100\text{ mV}$ ,  $V_{\text{OVERDRIVE}} = 100\text{ mV}$  unless otherwise noted.

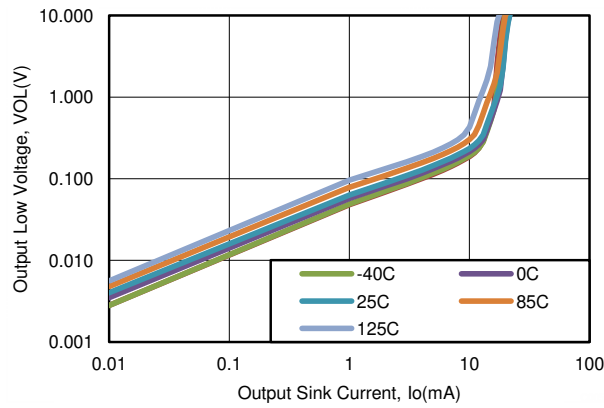

图 6-4. Supply Current vs. Supply Voltage



图 6-5. Total Supply Current vs. Input Voltage at 3V

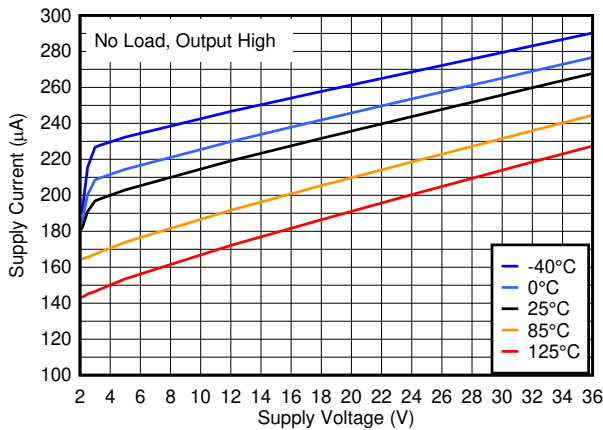

图 6-6. Total Supply Current vs. Input Voltage at 3.3V

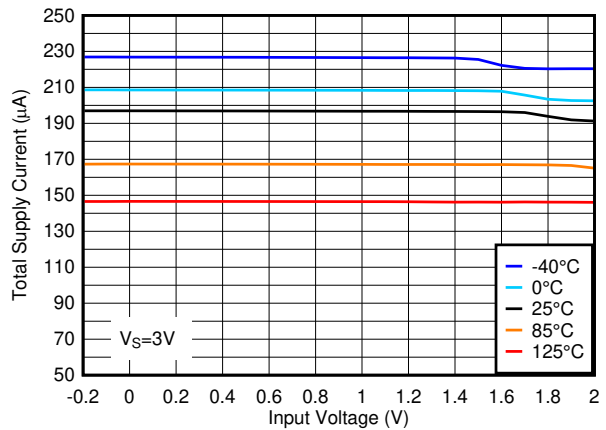

图 6-7. Total Supply Current vs. Input Voltage at 5V

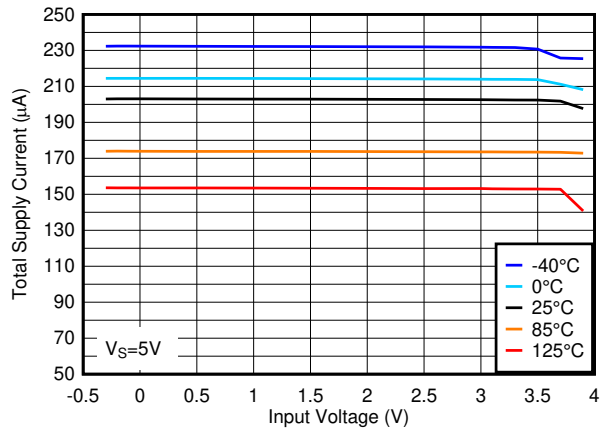

图 6-8. Total Supply Current vs. Input Voltage at 12V

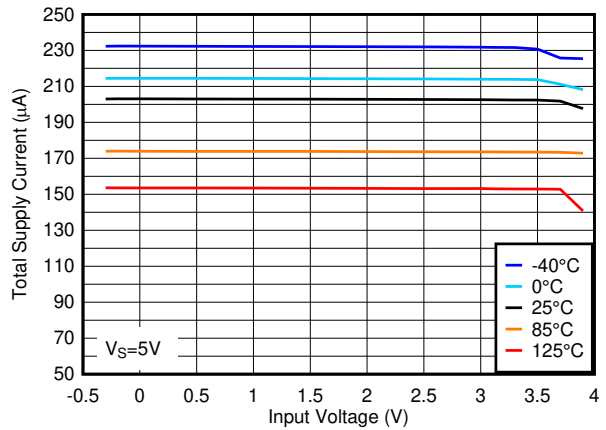

图 6-9. Total Supply Current vs. Input Voltage at 36V

### 6.13 Typical Characteristics, TL331B and TL391B (continued)

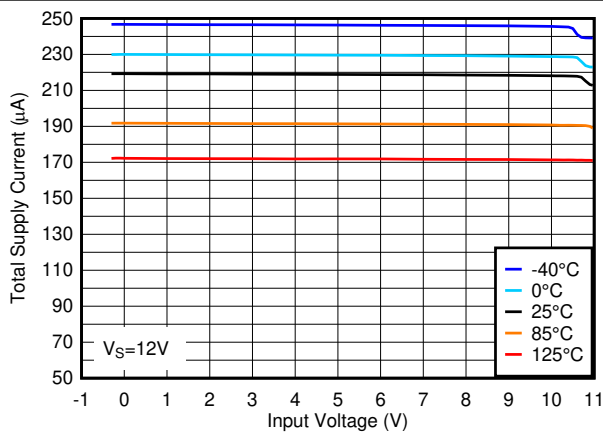
$T_A = 25^\circ\text{C}$ ,  $V_S = 5\text{ V}$ ,  $R_{\text{PULLUP}} = 5.1\text{ k}$ ,  $C_L = 15\text{ pF}$ ,  $V_{\text{CM}} = 0\text{ V}$ ,  $V_{\text{UNDERDRIVE}} = 100\text{ mV}$ ,  $V_{\text{OVERDRIVE}} = 100\text{ mV}$  unless otherwise noted.

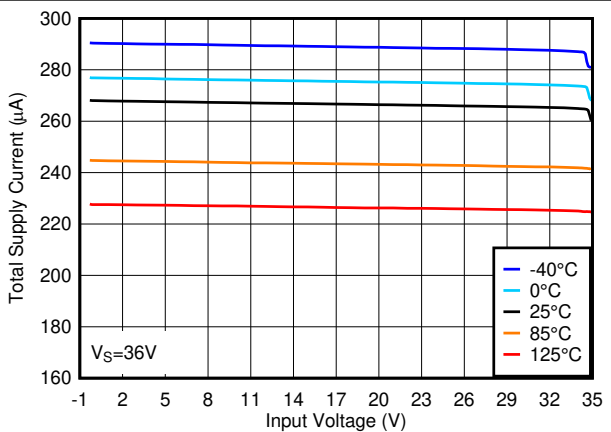

图 6-10. Input Bias Current vs. Supply Voltage



图 6-11. Input Bias Current vs. Input Voltage at 5V

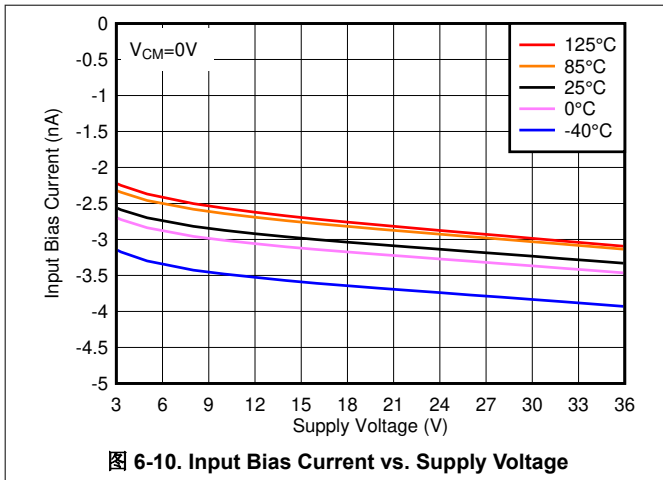

图 6-12. Input Bias Current vs. Input Voltage at 12V

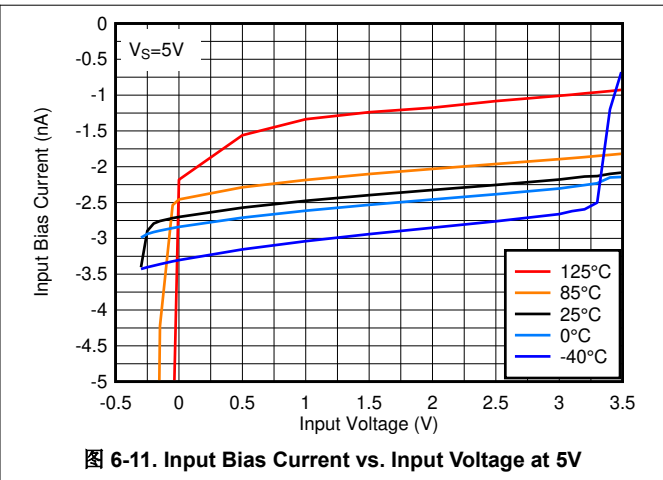

图 6-13. Input Bias Current vs. Input Voltage at 36V

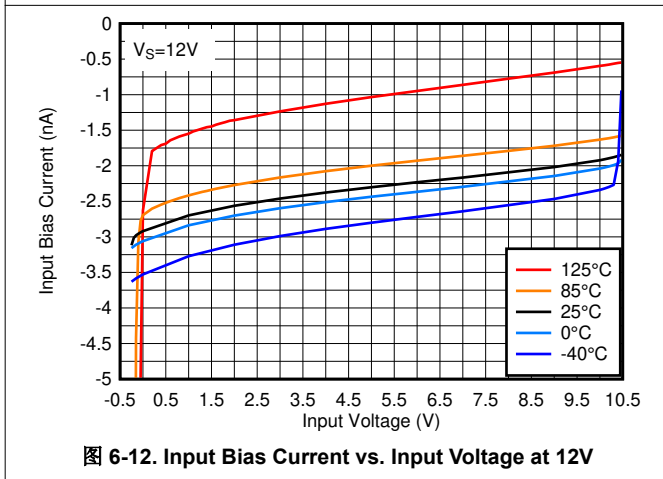

图 6-14. Input Offset Voltage vs. Supply Voltage at  $-40^\circ\text{C}$

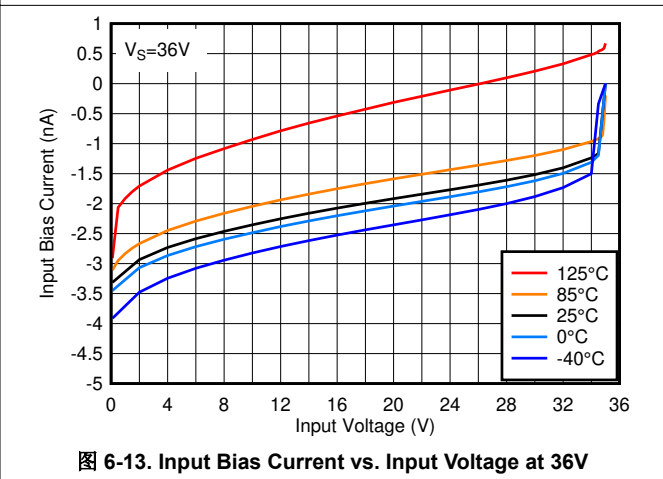

图 6-15. Input Offset Voltage vs. Supply Voltage at  $25^\circ\text{C}$

### 6.13 Typical Characteristics, TL331B and TL391B (continued)

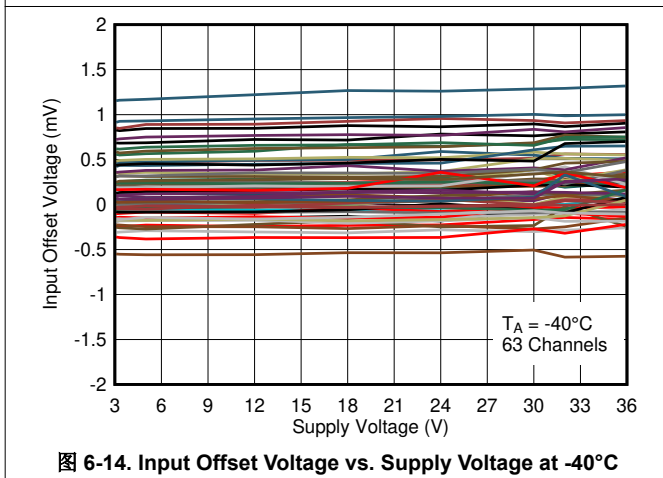
$T_A = 25^\circ\text{C}$ ,  $V_S = 5\text{ V}$ ,  $R_{\text{PULLUP}} = 5.1\text{ k}$ ,  $C_L = 15\text{ pF}$ ,  $V_{\text{CM}} = 0\text{ V}$ ,  $V_{\text{UNDERDRIVE}} = 100\text{ mV}$ ,  $V_{\text{OVERDRIVE}} = 100\text{ mV}$  unless otherwise noted.

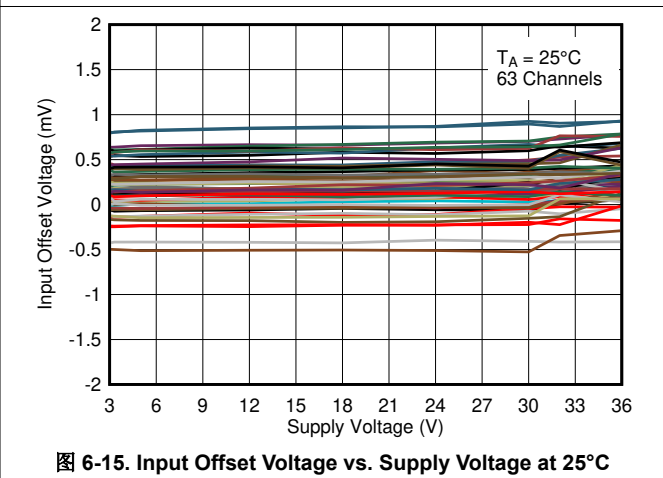

图 6-16. Input Offset Voltage vs. Supply Voltage at 85°C



图 6-17. Input Offset Voltage vs. Supply Voltage at 125°C

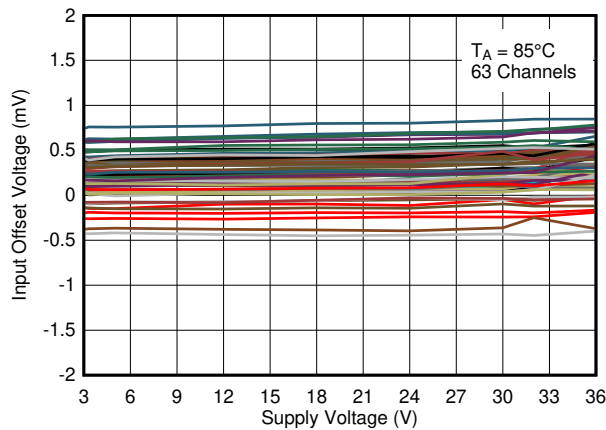

图 6-18. Input Offset Voltage vs. Temperature at 3V

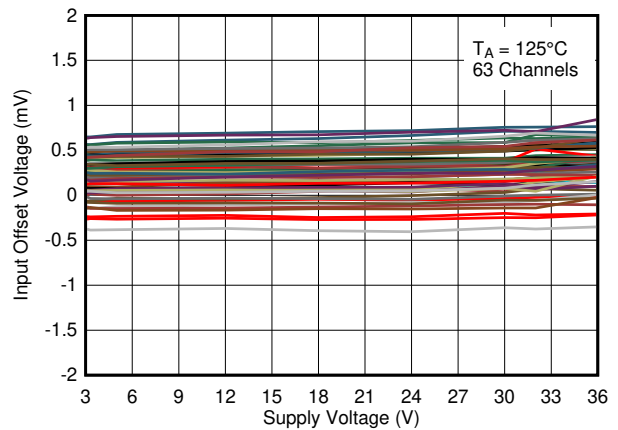

图 6-19. Input Offset Voltage vs. Temperature at 5V

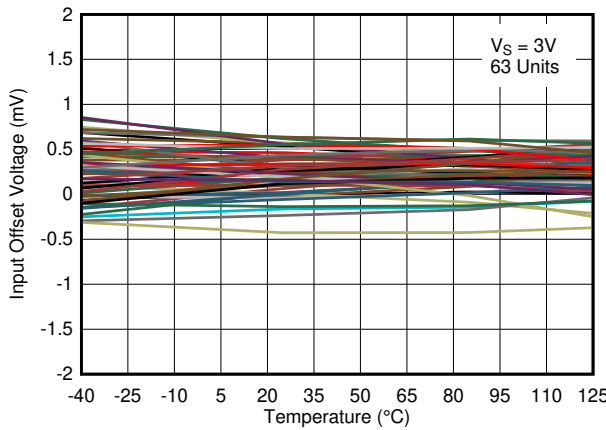

图 6-20. Input Offset Voltage vs. Temperature at 12V

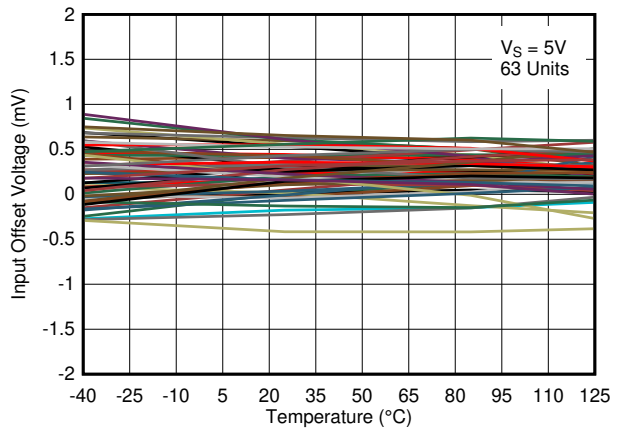

图 6-21. Input Offset Voltage vs. Temperature at 36V

### 6.13 Typical Characteristics, TL331B and TL391B (continued)

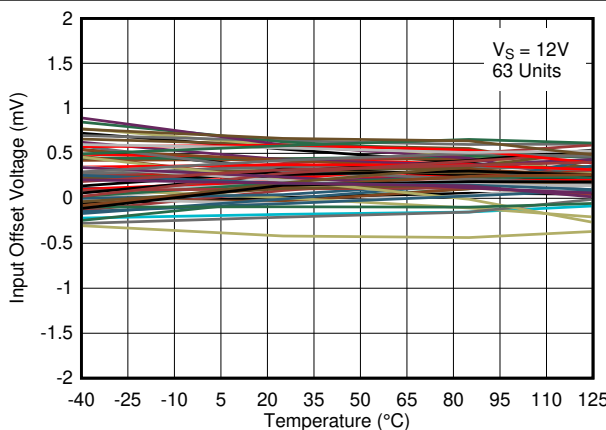
$T_A = 25^\circ\text{C}$ ,  $V_S = 5\text{ V}$ ,  $R_{\text{PULLUP}} = 5.1\text{ k}$ ,  $C_L = 15\text{ pF}$ ,  $V_{\text{CM}} = 0\text{ V}$ ,  $V_{\text{UNDERDRIVE}} = 100\text{ mV}$ ,  $V_{\text{OVERDRIVE}} = 100\text{ mV}$  unless otherwise noted.

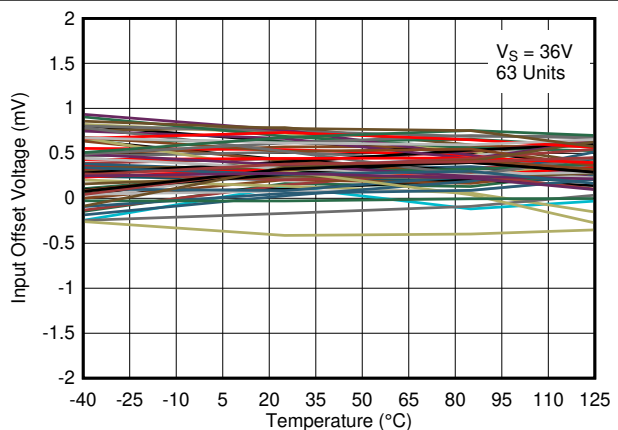

图 6-22. Output Low Voltage vs. Output Sinking Current at 3V



图 6-23. Output Low Voltage vs. Output Sinking Current at 5V

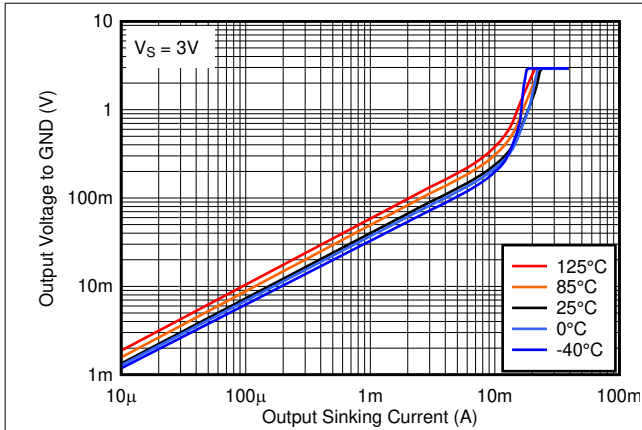

图 6-24. Output Low Voltage vs. Output Sinking Current at 12V

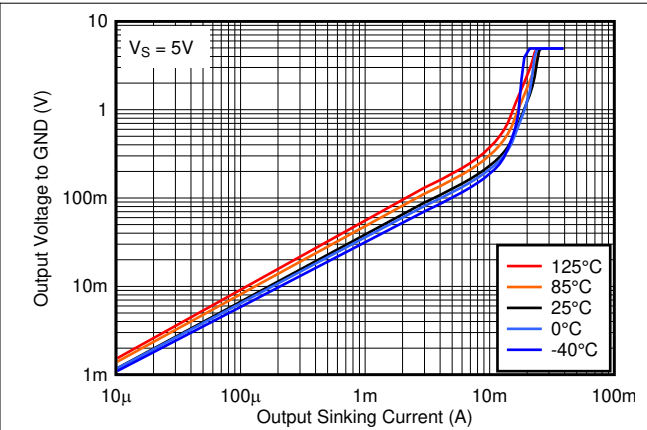

图 6-25. Output Low Voltage vs. Output Sinking Current at 36V

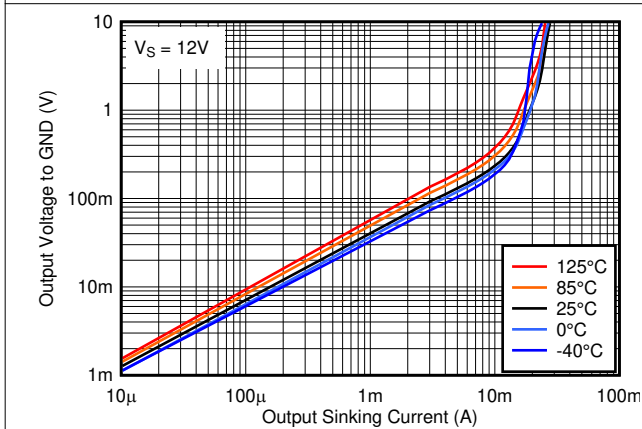

图 6-26. Output High Leakage Current vs. Temperature at 5V

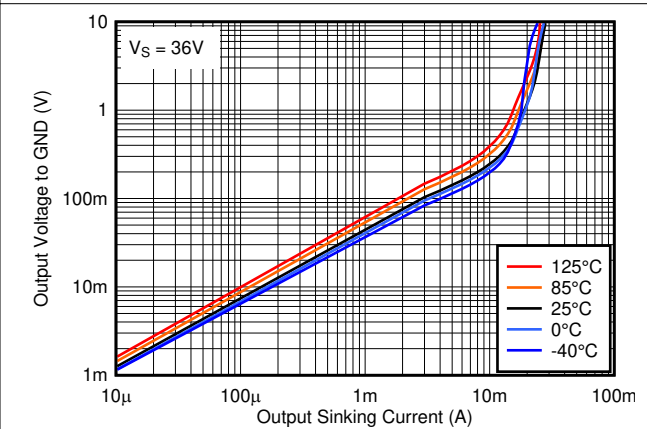

图 6-27. Output High Leakage Current vs. Temperature at 36V

### 6.13 Typical Characteristics, TL331B and TL391B (continued)

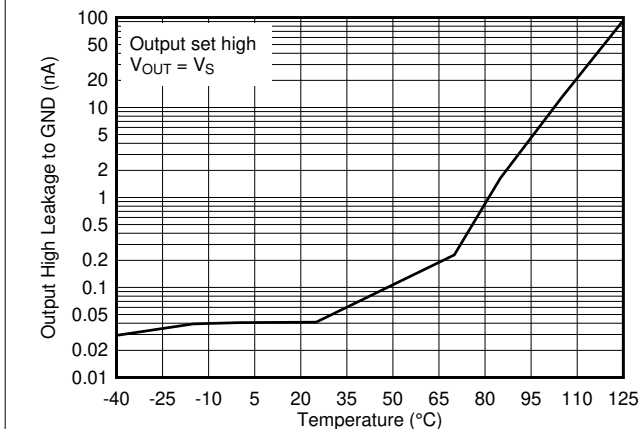
$T_A = 25^\circ\text{C}$ ,  $V_S = 5\text{ V}$ ,  $R_{\text{PULLUP}} = 5.1\text{ k}$ ,  $C_L = 15\text{ pF}$ ,  $V_{\text{CM}} = 0\text{ V}$ ,  $V_{\text{UNDERDRIVE}} = 100\text{ mV}$ ,  $V_{\text{OVERDRIVE}} = 100\text{ mV}$  unless otherwise noted.

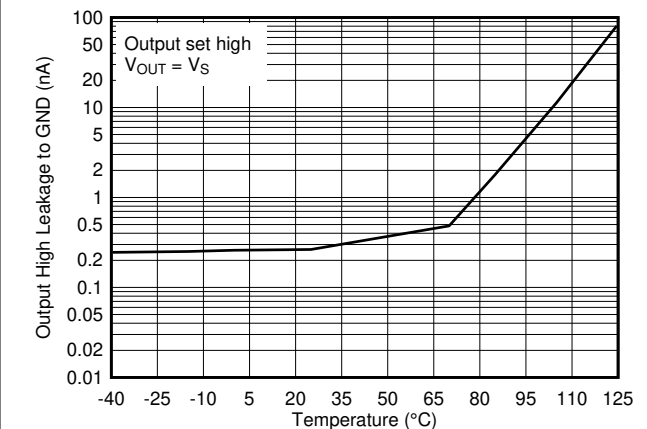
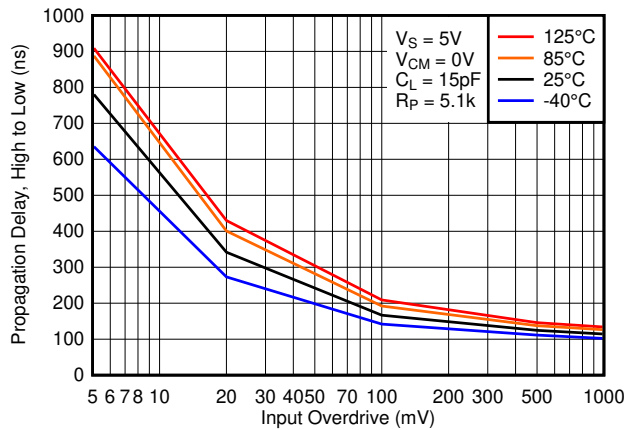

**图 6-28. High to Low Propagation Delay vs. Input Overdrive Voltage, 5V**

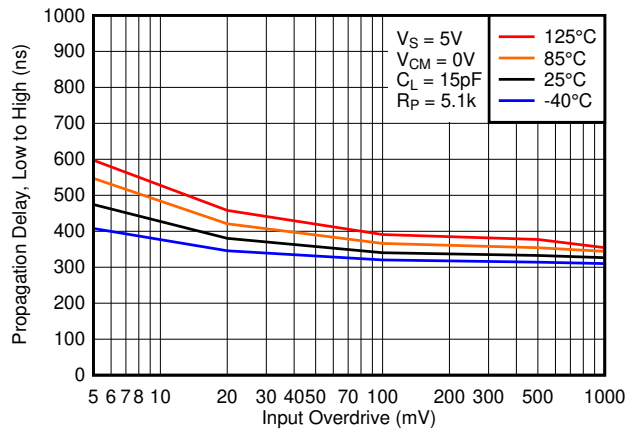

**图 6-29. Low to High Propagation Delay vs. Input Overdrive Voltage, 5V**

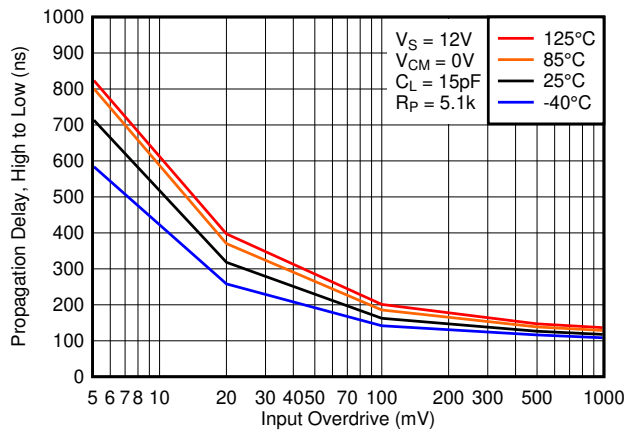

**图 6-30. High to Low Propagation Delay vs. Input Overdrive Voltage, 12V**

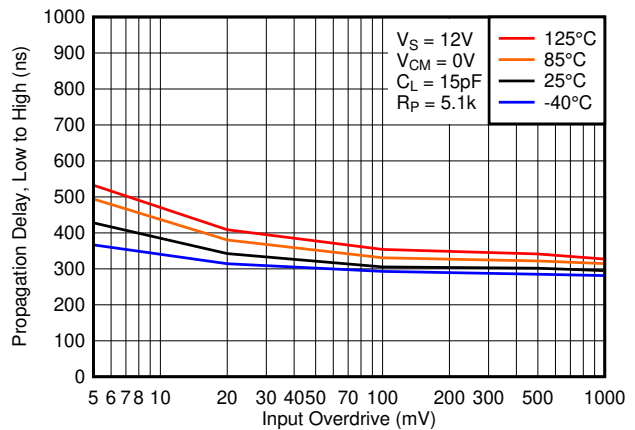

**图 6-31. Low to High Propagation Delay vs. Input Overdrive Voltage, 12V**

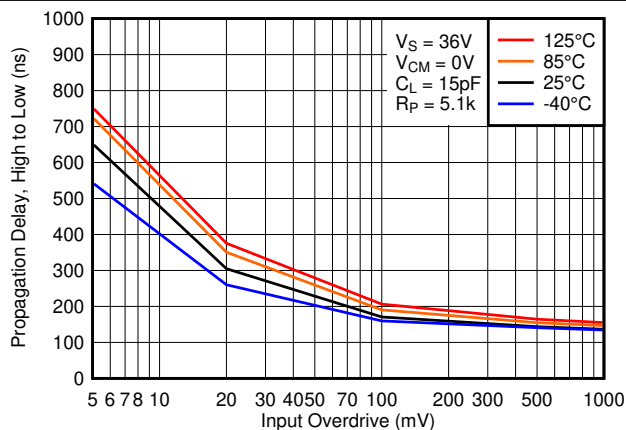

**图 6-32. High to Low Propagation Delay vs. Input Overdrive Voltage, 36V**

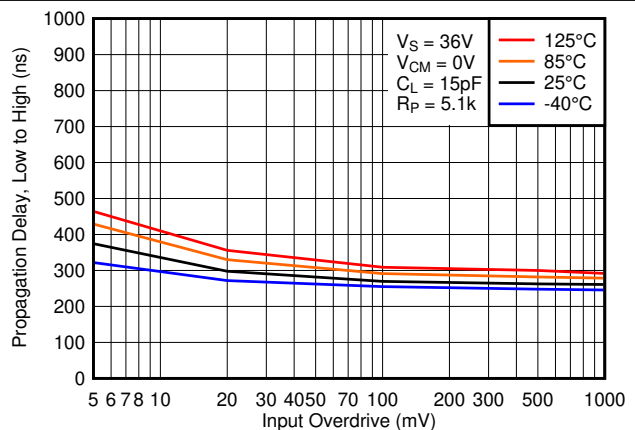

**图 6-33. Low to High Propagation Delay vs. Input Overdrive Voltage, 36V**

### 6.13 Typical Characteristics, TL331B and TL391B (continued)

$T_A = 25^\circ\text{C}$ ,  $V_S = 5\text{ V}$ ,  $R_{\text{PULLUP}} = 5.1\text{ k}$ ,  $C_L = 15\text{ pF}$ ,  $V_{\text{CM}} = 0\text{ V}$ ,  $V_{\text{UNDERDRIVE}} = 100\text{ mV}$ ,  $V_{\text{OVERDRIVE}} = 100\text{ mV}$  unless otherwise noted.

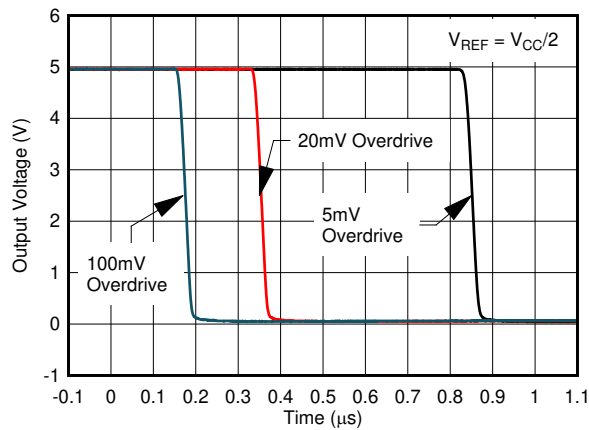

**图 6-34. Response Time for Various Overdrives, High-to-Low Transition**

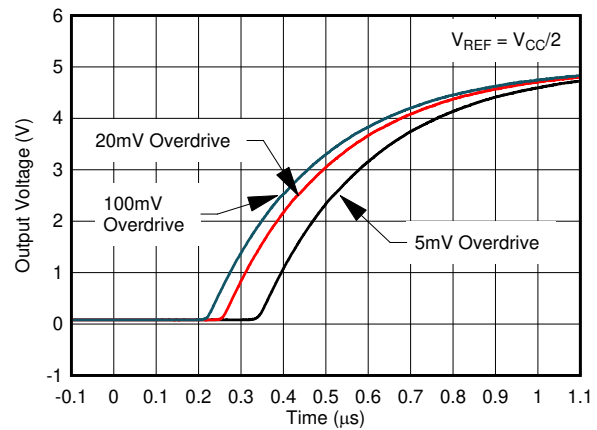

**图 6-35. Response Time for Various Overdrives, Low-to-High Transition**

## 7 Detailed Description

### 7.1 Overview

The TL331 family is a single comparator with the ability to operate up to 36 V on the supply pin. This standard device has proven ubiquity and versatility across a wide range of applications. This is due to its very wide supply voltages range (2 V to 36 V), low  $I_q$ , and fast response.

The open-collector output allows the user to configure the output's logic low voltage ( $V_{OL}$ ) and can be utilized to enable the comparator to be used in AND functionality.

The TL331B and TL391B are performance upgrades to standard TL331 using the latest process technologies allowing for lower offset voltages, lower input bias and supply currents and faster response time over an extended temperature range. The TL331B can drop-in replace the "I" or "K" versions of TL331. The TL391B is an alternate pinout for replacing competitive devices.

### 7.2 Functional Block Diagram

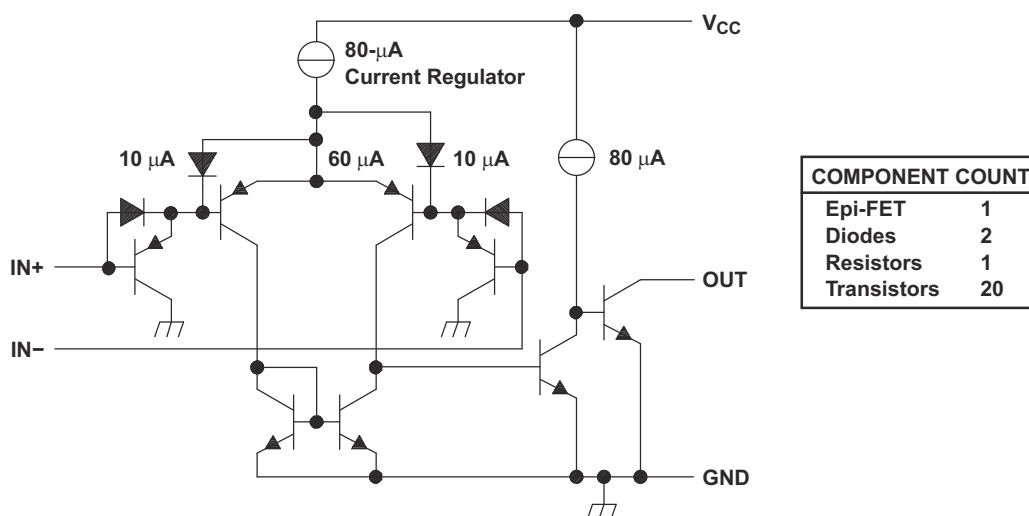

Current values shown are nominal.

### 7.3 Feature Description

TL331x family consists of a PNP Darlington pair input, allowing the device to operate with very high gain and fast response with minimal input bias current. The input Darlington pair creates a limit on the input common mode voltage capability, allowing TL331x to accurately function from ground to  $V_{CC} - 1.5$  V differential input.

The output consists of an open collector NPN (pull-down or low side) transistor. The output NPN will sink current when the negative input voltage is higher than the positive input voltage and the offset voltage. The  $V_{OL}$  is resistive and will scale with the output current. Please see [图 6-3](#) for  $V_{OL}$  values with respect to the output current.

### 7.4 Device Functional Modes

#### 7.4.1 Voltage Comparison

The TL331x operates solely as a voltage comparator, comparing the differential voltage between the positive and negative pins and outputting a logic low or high impedance (logic high with pull-up) based on the input differential polarity.

## 8 Application and Implementation

### Note

Information in the following applications sections is not part of the TI component specification, and TI does not warrant its accuracy or completeness. TI's customers are responsible for determining suitability of components for their purposes. Customers should validate and test their design implementation to confirm system functionality.

### 8.1 Application Information

TL331x will typically be used to compare a single signal to a reference or two signals against each other. Many users take advantage of the open drain output to drive the comparison logic output to a logic voltage level to an MCU or logic device. The wide supply range and high voltage capability makes TL331x optimal for level shifting to a higher or lower voltage.

### 8.2 Typical Application



图 8-1. Typical Application Schematic

#### 8.2.1 Design Requirements

For this design example, use the parameters listed in 表 8-1 as the input parameters.

表 8-1. Design Parameters

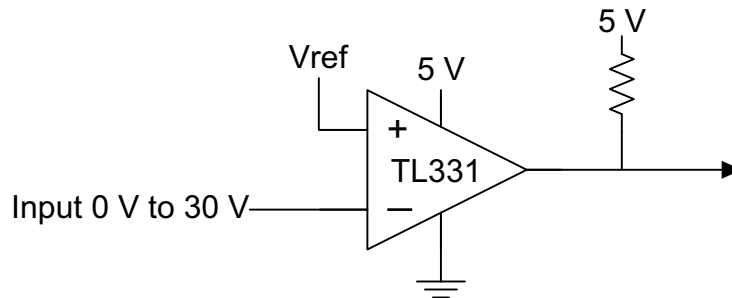
DESIGN PARAMETER	EXAMPLE VALUE
Input Voltage Range	0 V to $V_{CC} - 1.5$ V
Supply Voltage	2 V to 36 V
Logic Supply Voltage ( $R_{PULLUP}$ Voltage)	2 V to 36 V
Output Current ( $V_{LOGIC}/R_{PULLUP}$ )	1 $\mu$ A to 4 mA
Input Overdrive Voltage	100 mV
Reference Voltage	2.5 V
Load Capacitance ( $C_L$ )	15 pF

#### 8.2.2 Detailed Design Procedure

When using TL331x in a general comparator application, determine the following:

- Input voltage range
- Minimum overdrive voltage
- Output and drive current
- Response time

##### 8.2.2.1 Input Voltage Range

When choosing the input voltage range, the input common mode voltage range ( $V_{ICR}$ ) must be taken in to account. If temperature operation is above or below 25°C the  $V_{ICR}$  can range from 0 V to  $V_{CC} - 1.5$  V. This

limits the input voltage range to as high as  $V_{CC} - 1.5\text{ V}$  and as low as 0 V. Operation outside of this range can yield incorrect comparisons.

Below is a list of input voltage situation and their outcomes:

1. When both IN- and IN+ are both within the common mode range:
  - a. If IN- is higher than IN+ and the offset voltage, the output is low and the output transistor is sinking current
  - b. If IN- is lower than IN+ and the offset voltage, the output is high impedance and the output transistor is not conducting
2. When IN- is higher than common mode and IN+ is within common mode, the output is low and the output transistor is sinking current
3. When IN+ is higher than common mode and IN- is within common mode, the output is high impedance and the output transistor is not conducting
4. When IN- and IN+ are both higher than common mode, the output is low and the output transistor is sinking current

### 8.2.2.2 Minimum Overdrive Voltage

Overdrive Voltage is the differential voltage produced between the positive and negative inputs of the comparator over the offset voltage ( $V_{IO}$ ). In order to make an accurate comparison the Overdrive Voltage ( $V_{OD}$ ) should be higher than the input offset voltage ( $V_{IO}$ ). Overdrive voltage can also determine the response time of the comparator, with the response time decreasing with increasing overdrive. [图 8-2](#) and [图 8-3](#) show positive and negative response times with respect to overdrive voltage.

### 8.2.2.3 Output and Drive Current

Output current is determined by the load/pull-up resistance and logic/pull-up voltage. The output current will produce a output low voltage ( $V_{OL}$ ) from the comparator. In which  $V_{OL}$  is proportional to the output current. Use [图 6-3](#) to determine  $V_{OL}$  based on the output current.

The output current can also effect the transient response. More is explained in the next section.

### 8.2.2.4 TL331B & TL391B ESD Protection

The "B" versions add dedicated ESD protections on all the pins for improved ESD performance. Please see Application Note [SNOAA35](#) for more information.

### 8.2.2.5 Response Time

Response time is a function of input over drive. See [节 8.2.3](#) for typical response times. The rise and fall times can be determined by the load capacitance ( $C_L$ ), load/pullup resistance ( $R_{PULLUP}$ ), and equivalent collector-emitter resistance ( $R_{CE}$ ).

- The rise time ( $\tau_R$ ) is approximately  $\tau_R \sim R_{PULLUP} \times C_L$
- The fall time ( $\tau_F$ ) is approximately  $\tau_F \sim R_{CE} \times C_L$ 
  - $R_{CE}$  can be determined by taking the slope of [图 6-3](#) in its linear region at the desired temperature, or by dividing the  $V_{OL}$  by  $I_{out}$

### 8.2.3 Application Curves

The following curves were generated with 5 V on  $V_{CC}$  and  $V_{Logic}$ ,  $R_{PULLUP} = 5.1\text{ k}\Omega$ , and 50 pF scope probe.

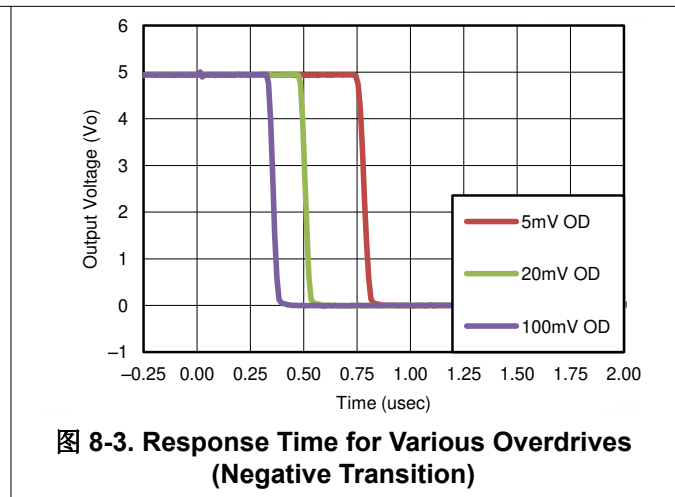
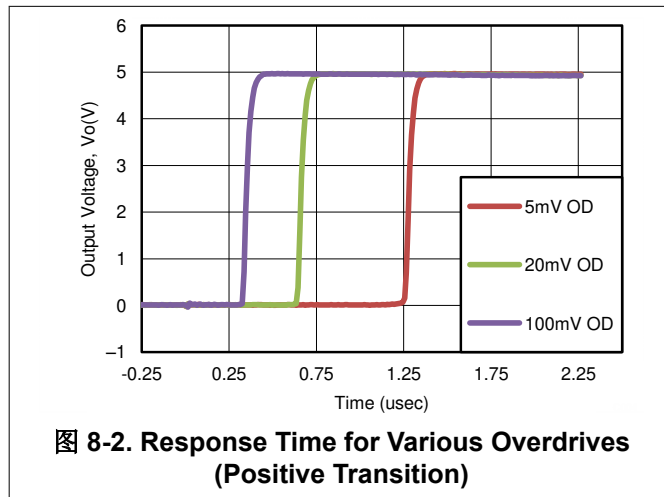

## 9 Power Supply Recommendations

For fast response and comparison applications with noisy or AC inputs, it is recommended to use a bypass capacitor on the supply pin to reject any variation on the supply voltage. This variation can eat into the comparator's input common mode range and create an inaccurate comparison.

## 10 Layout

### 10.1 Layout Guidelines

For accurate comparator applications without hysteresis it is important maintain a stable power supply with minimized noise and glitches, which can affect the high level input common mode voltage range. In order to achieve this, it is best to add a bypass capacitor between the supply voltage and ground. This should be implemented on the positive power supply and negative supply (if available). If a negative supply is not being used, do not put a capacitor between the IC's GND pin and system ground.

### 10.2 Layout Example

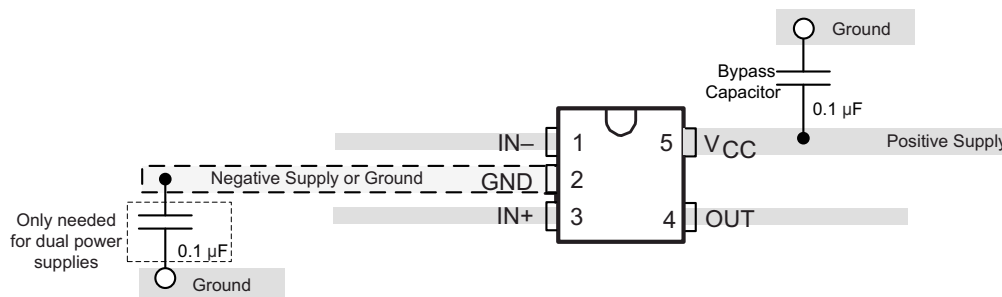

**图 10-1. TL331 Layout Example**

## 11 Device and Documentation Support

### 11.1 Documentation Support

#### 11.1.1 Related Documentation

[Application Design Guidelines for LM339, LM393, TL331 Family Comparators - SNOAA35](#)

[Analog Engineers Circuit Cookbook: Amplifiers \(See Comparators section\) - SLYY137](#)

[Precision Design, Comparator with Hysteresis Reference Design- TIDU020](#)

[Window comparator circuit - SBOA221](#)

[Reference Design, Window Comparator Reference Design- TIPD178](#)

[Comparator with and without hysteresis circuit - SBOA219](#)

[Inverting comparator with hysteresis circuit - SNOA997](#)

[Non-Inverting Comparator With Hysteresis Circuit - SBOA313](#)

[Zero crossing detection using comparator circuit - SNOA999](#)

[PWM generator circuit - SBOA212](#)

[How to Implement Comparators for Improving Performance of Rotary Encoder in Industrial Drive Applications - SNOAA41](#)

[A Quad of Independently Func Comparators - SNOA654](#)

### 11.2 Receiving Notification of Documentation Updates

To receive notification of documentation updates, navigate to the device product folder on ti.com. In the upper right corner, click on *Alert me* to register and receive a weekly digest of any product information that has changed. For change details, review the revision history included in any revised document.

### 11.3 Support Resources

[TI E2E™ support forums](#) are an engineer's go-to source for fast, verified answers and design help — straight from the experts. Search existing answers or ask your own question to get the quick design help you need.

Linked content is provided "AS IS" by the respective contributors. They do not constitute TI specifications and do not necessarily reflect TI's views; see TI's [Terms of Use](#).

### 11.4 Trademarks

TI E2E™ is a trademark of Texas Instruments.

所有商标均为其各自所有者的财产。

### 11.5 Electrostatic Discharge Caution



This integrated circuit can be damaged by ESD. Texas Instruments recommends that all integrated circuits be handled with appropriate precautions. Failure to observe proper handling and installation procedures can cause damage.

ESD damage can range from subtle performance degradation to complete device failure. Precision integrated circuits may be more susceptible to damage because very small parametric changes could cause the device not to meet its published specifications.

### 11.6 Glossary

[TI Glossary](#) This glossary lists and explains terms, acronyms, and definitions.

## 12 Mechanical, Packaging, and Orderable Information

The following pages include mechanical, packaging, and orderable information. This information is the most current data available for the designated devices. This data is subject to change without notice and revision of this document. For browser-based versions of this data sheet, refer to the left-hand navigation.

**PACKAGING INFORMATION**

Orderable Device	Status (1)	Package Type	Package Drawing	Pins	Package Qty	Eco Plan (2)	Lead finish/ Ball material (6)	MSL Peak Temp (3)	Op Temp (°C)	Device Marking (4/5)	Samples
TL331BIDBVR	ACTIVE	SOT-23	DBV	5	3000	RoHS & Green	NIPDAU	Level-1-260C-UNLIM	-40 to 125	331B	<a href="#">Samples</a>
TL331IDBVR	ACTIVE	SOT-23	DBV	5	3000	RoHS & Green	NIPDAU	Level-1-260C-UNLIM	-40 to 85	(T1I8, T1IG, T1IL, T1IS)	<a href="#">Samples</a>
TL331IDBvre4	ACTIVE	SOT-23	DBV	5	3000	RoHS & Green	NIPDAU	Level-1-260C-UNLIM	-40 to 85	(T1I8, T1IG)	<a href="#">Samples</a>
TL331IDBVRG4	ACTIVE	SOT-23	DBV	5	3000	RoHS & Green	NIPDAU	Level-1-260C-UNLIM	-40 to 85	(T1I8, T1IG)	<a href="#">Samples</a>
TL331IDBVT	ACTIVE	SOT-23	DBV	5	250	RoHS & Green	NIPDAU	Level-1-260C-UNLIM	-40 to 85	(T1I8, T1IG, T1IL, T1IU)	<a href="#">Samples</a>
TL331IDBVTG4	ACTIVE	SOT-23	DBV	5	250	RoHS & Green	NIPDAU	Level-1-260C-UNLIM	-40 to 85	T1IG	<a href="#">Samples</a>
TL331KDBVR	ACTIVE	SOT-23	DBV	5	3000	RoHS & Green	NIPDAU   SN	Level-1-260C-UNLIM	-40 to 105	(T1K8, T1KG, T1KJ, T1KL)	<a href="#">Samples</a>
TL331KDBVRG4	ACTIVE	SOT-23	DBV	5	3000	RoHS & Green	SN	Level-1-260C-UNLIM	-40 to 105	(T1K8, T1KG, T1KJ, T1KL)	<a href="#">Samples</a>
TL331KDBVT	ACTIVE	SOT-23	DBV	5	250	RoHS & Green	SN	Level-1-260C-UNLIM	-40 to 105	(T1K8, T1KG, T1KJ, T1KL)	<a href="#">Samples</a>
TL391BIDBVR	ACTIVE	SOT-23	DBV	5	3000	RoHS & Green	NIPDAU	Level-1-260C-UNLIM	-40 to 125	391B	<a href="#">Samples</a>

(1) The marketing status values are defined as follows:

**ACTIVE:** Product device recommended for new designs.

**LIFEBUY:** TI has announced that the device will be discontinued, and a lifetime-buy period is in effect.

**NRND:** Not recommended for new designs. Device is in production to support existing customers, but TI does not recommend using this part in a new design.

**PREVIEW:** Device has been announced but is not in production. Samples may or may not be available.

**OBSELETE:** TI has discontinued the production of the device.

(2) **RoHS:** TI defines "RoHS" to mean semiconductor products that are compliant with the current EU RoHS requirements for all 10 RoHS substances, including the requirement that RoHS substance do not exceed 0.1% by weight in homogeneous materials. Where designed to be soldered at high temperatures, "RoHS" products are suitable for use in specified lead-free processes. TI may reference these types of products as "Pb-Free".

**RoHS Exempt:** TI defines "RoHS Exempt" to mean products that contain lead but are compliant with EU RoHS pursuant to a specific EU RoHS exemption.

**Green:** TI defines "Green" to mean the content of Chlorine (Cl) and Bromine (Br) based flame retardants meet JS709B low halogen requirements of <=1000ppm threshold. Antimony trioxide based flame retardants must also meet the <=1000ppm threshold requirement.

(3) MSL, Peak Temp. - The Moisture Sensitivity Level rating according to the JEDEC industry standard classifications, and peak solder temperature.

- (4) There may be additional marking, which relates to the logo, the lot trace code information, or the environmental category on the device.
- (5) Multiple Device Markings will be inside parentheses. Only one Device Marking contained in parentheses and separated by a "~" will appear on a device. If a line is indented then it is a continuation of the previous line and the two combined represent the entire Device Marking for that device.
- (6) Lead finish/Ball material - Orderable Devices may have multiple material finish options. Finish options are separated by a vertical ruled line. Lead finish/Ball material values may wrap to two lines if the finish value exceeds the maximum column width.

**Important Information and Disclaimer:**The information provided on this page represents TI's knowledge and belief as of the date that it is provided. TI bases its knowledge and belief on information provided by third parties, and makes no representation or warranty as to the accuracy of such information. Efforts are underway to better integrate information from third parties. TI has taken and continues to take reasonable steps to provide representative and accurate information but may not have conducted destructive testing or chemical analysis on incoming materials and chemicals. TI and TI suppliers consider certain information to be proprietary, and thus CAS numbers and other limited information may not be available for release.

In no event shall TI's liability arising out of such information exceed the total purchase price of the TI part(s) at issue in this document sold by TI to Customer on an annual basis.

**OTHER QUALIFIED VERSIONS OF TL331, TL331B, TL391B :**

- Automotive : [TL331-Q1](#), [TL331B-Q1](#), [TL391B-Q1](#)
- Enhanced Product : [TL331-EP](#)

NOTE: Qualified Version Definitions:

- Automotive - Q100 devices qualified for high-reliability automotive applications targeting zero defects
- Enhanced Product - Supports Defense, Aerospace and Medical Applications

**TAPE AND REEL INFORMATION**

**QUADRANT ASSIGNMENTS FOR PIN 1 ORIENTATION IN TAPE**

\*All dimensions are nominal

Device	Package Type	Package Drawing	Pins	SPQ	Reel Diameter (mm)	Reel Width W1 (mm)	A0 (mm)	B0 (mm)	K0 (mm)	P1 (mm)	W (mm)	Pin1 Quadrant
TL331BIDBVR	SOT-23	DBV	5	3000	180.0	8.4	3.2	3.2	1.4	4.0	8.0	Q3
TL331IDBVR	SOT-23	DBV	5	3000	180.0	8.4	3.23	3.17	1.37	4.0	8.0	Q3
TL331IDBVR	SOT-23	DBV	5	3000	178.0	9.0	3.23	3.17	1.37	4.0	8.0	Q3
TL331IDBVRG4	SOT-23	DBV	5	3000	178.0	9.0	3.23	3.17	1.37	4.0	8.0	Q3
TL331IDBVT	SOT-23	DBV	5	250	178.0	9.0	3.3	3.2	1.4	4.0	8.0	Q3
TL331IDBVTG4	SOT-23	DBV	5	250	178.0	9.0	3.3	3.2	1.4	4.0	8.0	Q3
TL331KDBVR	SOT-23	DBV	5	3000	178.0	9.0	3.23	3.17	1.37	4.0	8.0	Q3
TL331KDBVR	SOT-23	DBV	5	3000	178.0	9.0	3.3	3.2	1.4	4.0	8.0	Q3
TL331KDBVT	SOT-23	DBV	5	250	178.0	9.0	3.23	3.17	1.37	4.0	8.0	Q3
TL331KDBVT	SOT-23	DBV	5	250	178.0	9.0	3.3	3.2	1.4	4.0	8.0	Q3
TL391BIDBVR	SOT-23	DBV	5	3000	180.0	8.4	3.2	3.2	1.4	4.0	8.0	Q3

**TAPE AND REEL BOX DIMENSIONS**

\*All dimensions are nominal

Device	Package Type	Package Drawing	Pins	SPQ	Length (mm)	Width (mm)	Height (mm)
TL331BIDBVR	SOT-23	DBV	5	3000	210.0	185.0	35.0
TL331IDBVR	SOT-23	DBV	5	3000	202.0	201.0	28.0
TL331IDBVR	SOT-23	DBV	5	3000	180.0	180.0	18.0
TL331IDBVRG4	SOT-23	DBV	5	3000	180.0	180.0	18.0
TL331IDBVT	SOT-23	DBV	5	250	180.0	180.0	18.0
TL331IDBVTG4	SOT-23	DBV	5	250	180.0	180.0	18.0
TL331KDBVR	SOT-23	DBV	5	3000	180.0	180.0	18.0
TL331KDBVR	SOT-23	DBV	5	3000	180.0	180.0	18.0
TL331KDBVT	SOT-23	DBV	5	250	180.0	180.0	18.0
TL331KDBVT	SOT-23	DBV	5	250	180.0	180.0	18.0
TL391BIDBVR	SOT-23	DBV	5	3000	210.0	185.0	35.0



# EXAMPLE BOARD LAYOUT

DBV0005A

SOT-23 - 1.45 mm max height

SMALL OUTLINE TRANSISTOR

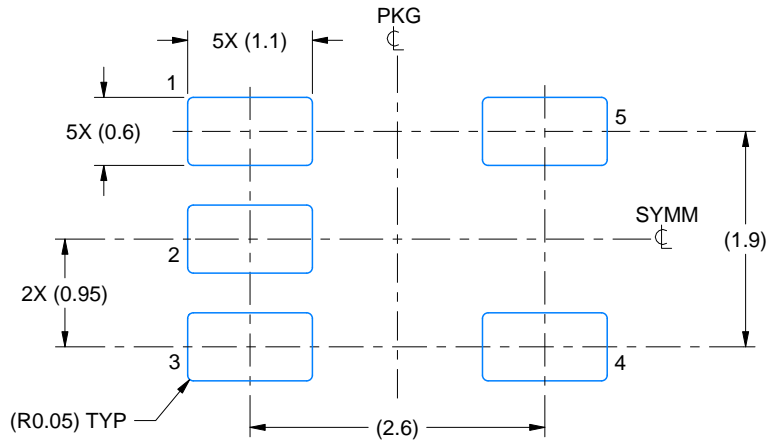

LAND PATTERN EXAMPLE  
EXPOSED METAL SHOWN  
SCALE:15X

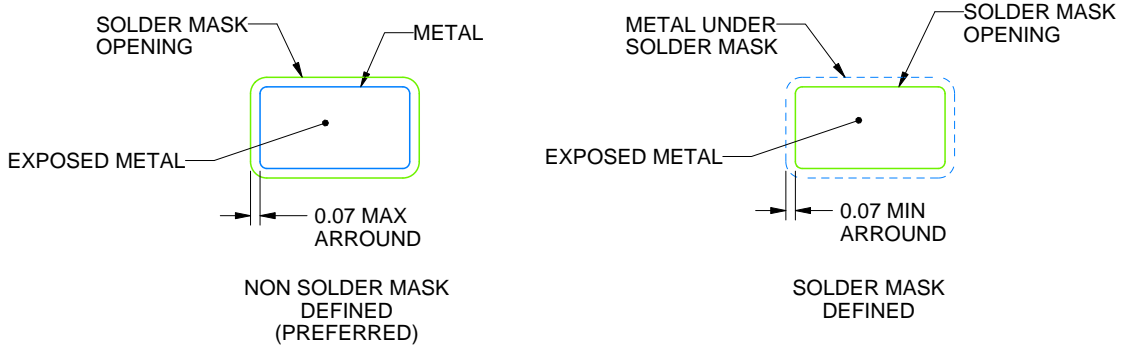

SOLDER MASK DETAILS

4214839/F 06/2021

NOTES: (continued)

- 5. Publication IPC-7351 may have alternate designs.
- 6. Solder mask tolerances between and around signal pads can vary based on board fabrication site.

# EXAMPLE STENCIL DESIGN

DBV0005A

SOT-23 - 1.45 mm max height

SMALL OUTLINE TRANSISTOR

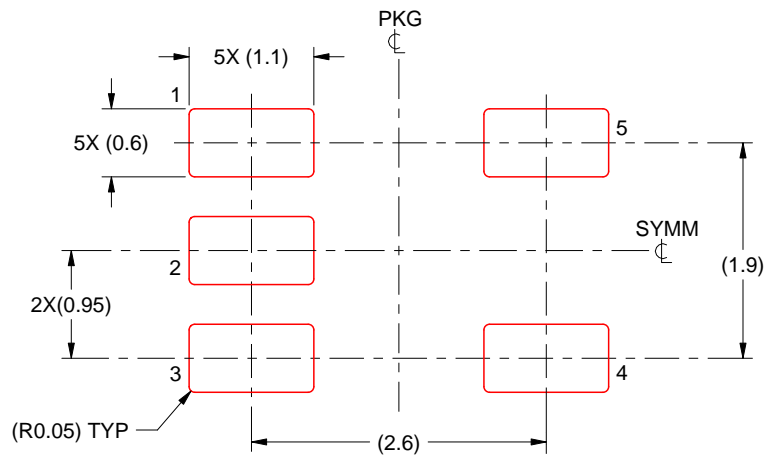

SOLDER PASTE EXAMPLE  
BASED ON 0.125 mm THICK STENCIL  
SCALE:15X

4214839/F 06/2021

NOTES: (continued)

7. Laser cutting apertures with trapezoidal walls and rounded corners may offer better paste release. IPC-7525 may have alternate design recommendations.
8. Board assembly site may have different recommendations for stencil design.

## 重要声明和免责声明

TI“按原样”提供技术和可靠性数据（包括数据表）、设计资源（包括参考设计）、应用或其他设计建议、网络工具、安全信息和其他资源，不保证没有瑕疵且不做任何明示或暗示的担保，包括但不限于对适销性、某特定用途方面的适用性或不侵犯任何第三方知识产权的暗示担保。

这些资源可供使用 TI 产品进行设计的熟练开发人员使用。您将自行承担以下全部责任：(1) 针对您的应用选择合适的 TI 产品，(2) 设计、验证并测试您的应用，(3) 确保您的应用满足相应标准以及任何其他功能安全、信息安全、监管或其他要求。

这些资源如有变更，恕不另行通知。TI 授权您仅可将这些资源用于研发本资源所述的 TI 产品的应用。严禁对这些资源进行其他复制或展示。您无权使用任何其他 TI 知识产权或任何第三方知识产权。您应全额赔偿因在这些资源的使用中对 TI 及其代表造成的任何索赔、损害、成本、损失和债务，TI 对此概不负责。

TI 提供的产品受 [TI 的销售条款](#) 或 [ti.com](#) 上其他适用条款/TI 产品随附的其他适用条款的约束。TI 提供这些资源并不会扩展或以其他方式更改 TI 针对 TI 产品发布的适用的担保或担保免责声明。

TI 反对并拒绝您可能提出的任何其他或不同的条款。

邮寄地址：Texas Instruments, Post Office Box 655303, Dallas, Texas 75265

Copyright © 2022，德州仪器 (TI) 公司