

TPS7A30 –35-V, –200-mA, Ultralow-Noise, Negative Linear Regulator

1 Features

- Input Voltage Range: –3 V to –35 V
- Noise:
 - 14 μV_{RMS} (20 Hz to 20 kHz)
 - 15.1 μV_{RMS} (10 Hz to 100 kHz)
- Power-Supply Ripple Rejection:
 - 72 dB (120 Hz)
 - ≥ 55 dB (10 Hz to 700 kHz)
- Adjustable Output: –1.18 V to –33 V
- Maximum Output Current: 200 mA
- Dropout Voltage: 216 mV at 100 mA
- Stable with Ceramic Capacitors ≥ 2.2 μF
- CMOS Logic-Level-Compatible Enable Pin
- Built-In, Fixed, Current Limit and Thermal Shutdown Protection
- Packages: 8-Pin HVSSOP PowerPAD™ and 3-mm \times 3-mm VSON
- Operating Temperature Range: –40°C to 125°C

2 Applications

- Supply Rails for Operational Amplifiers, DACs, ADCs, and Other High-Precision Analog Circuitry
- Audio
- Post DC-DC Converter Regulation and Ripple Filtering
- Test and Measurement
- RX, TX, and PA Circuitry
- Industrial Instrumentation
- Base Stations and Telecom Infrastructure
- –12-V and –24-V Industrial Buses

3 Description

The TPS7A30 series of devices are negative, high-voltage (–35 V), ultralow-noise (15.1 μV_{RMS} , 72-dB PSRR) linear regulators that can source a maximum load of 200 mA.

These linear regulators include a CMOS logic-level-compatible enable pin and capacitor-programmable soft-start function that allows for customized power-management schemes. Other features include built-in current limit and thermal shutdown protection to safeguard the device and system during fault conditions.

The TPS7A30 family is designed using bipolar technology, and is ideal for high-accuracy, high-precision instrumentation applications where clean voltage rails are critical to maximize system performance. This design makes the device an excellent choice to power operational amplifiers, analog-to-digital converters (ADCs), digital-to-analog converters (DACs), and other high-performance analog circuitry.

In addition, the TPS7A30 family of linear regulators is suitable for post dc-dc converter regulation. By filtering out the output voltage ripple inherent to dc-dc switching conversion, maximum system performance is provided in sensitive instrumentation, test and measurement, audio, and RF applications.

For applications that require positive and negative high-performance rails, consider TI's [TPS7A49](#) family of positive high-voltage, ultralow-noise linear regulators.

Device Information⁽¹⁾

PART NUMBER	PACKAGE	BODY SIZE (NOM)
TPS7A30	HVSSOP (8)	3.00 mm \times 3.00 mm
	VSON (8)	3.00 mm \times 3.00 mm

(1) For all available packages, see the orderable addendum at the end of the data sheet.

Post DC-DC Converter Regulation for High-Performance Analog Circuitry

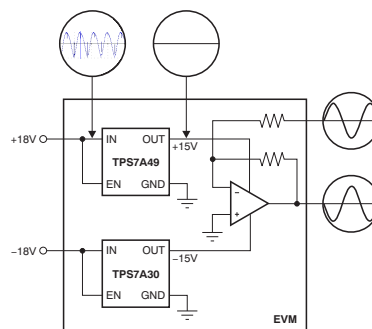

Table of Contents

1 Features	1	9 Application and Implementation	17
2 Applications	1	9.1 Application Information.....	17
3 Description	1	9.2 Typical Application	20
4 Revision History	2	9.3 Do's and Don'ts.....	23
5 Pin Configuration and Functions	4	10 Power Supply Recommendations	23
6 Specifications	5	11 Layout	24
6.1 Absolute Maximum Ratings	5	11.1 Layout Guidelines	24
6.2 ESD Ratings	5	11.2 Layout Examples.....	24
6.3 Recommended Operating Conditions.....	6	11.3 Thermal Considerations	26
6.4 Thermal Information	6	11.4 Power Dissipation	26
6.5 Electrical Characteristics.....	7	12 Device and Documentation Support	28
6.6 Typical Characteristics.....	8	12.1 Device Support	28
7 Parameter Measurement Information	13	12.2 Documentation Support	28
8 Detailed Description	14	12.3 Community Resources.....	28
8.1 Overview	14	12.4 Trademarks	28
8.2 Functional Block Diagram	14	12.5 Electrostatic Discharge Caution.....	28
8.3 Feature Description.....	15	12.6 Glossary	29
8.4 Device Functional Modes.....	16	13 Mechanical, Packaging, and Orderable Information	29

4 Revision History

NOTE: Page numbers for previous revisions may differ from page numbers in the current version.

Changes from Revision C (April 2015) to Revision D	Page
• Added DRB package to document	1
• Added TI Design.....	1
• Changed <i>Packages</i> Features bullet	1
• Added VSON row to <i>Device Information</i> table	1
• Added DRB package to <i>Pin Configuration and Functions</i> section.....	4
• Changed EN pin description in <i>Pin Functions</i> table: updated voltage symbols	4
• Added DRB column to <i>Thermal Information</i> table.....	6
• Changed test conditions of last row in $ I_{EN} $ parameter of <i>Electrical Characteristics</i> table	7
• Changed title and y-axis of Figure 7 to <i>Ground Current</i>	9
• Changed y-axis of Figure 11 and Figure 12 to I_Q	9
• Changed V_{EN} value of disabled mode in Table 1	16
• Changed first sentence of <i>Application Information</i> section	17
• Added Table 2 and respective description to <i>Adjustable Operation</i> section.....	17
• Deleted third sentence from <i>Capacitor Recommendations</i> section	17
• Changed third paragraph of <i>Power for Precision Analog</i> section	19
• Changed description of start-up time in <i>Design Requirements</i> section	20
• Changed Equation 3	20
• Changed Equation 8	21
• Changed fifth item in <i>Do's and Don'ts</i> section	23
• Changed Figure 40 footnote	25
• Changed 35°C to 45°C in <i>Thermal Considerations</i> section	26

Changes from Revision B (December 2013) to Revision C **Page**

- Added *ESD Ratings* table, *Feature Description* section, *Device Functional Modes*, *Application and Implementation* section, *Power Supply Recommendations* section, *Layout* section, *Device and Documentation Support* section, and *Mechanical, Packaging, and Orderable Information* section 1
- Changed document title 1
- Changed *Thermal Information* table; updated values 6
- Deleted *Dissipation Ratings* table 6
- Changed condition statement for *Electrical Characteristics* table 7
- Added footnote about measuring V_{REF} to *Electrical Characteristics* table 7
- Added V_{FB} parameter to *Electrical Characteristics* table 7
- Changed parametric symbol for current limit from I_{LIM} to I_{CL} 7
- Changed C_{BYP} notation to C_{FF} throughout data sheet 7
- Changed condition statement for *Typical Characteristics* 8
- Changed [Figure 14](#); changed notation for C_{BYP} to C_{FF} 9
- Changed [Figure 16](#); changed notation for C_{BYP} to C_{FF} 9
- Changed [Figure 18](#); changed notation for C_{BYP} to C_{FF} 9
- Changed [Figure 32](#); changed C_{BYP} to C_{FF} 20

Changes from Revision A (March 2011) to Revision B **Page**

- Changed V_{REF} parameter typical specification in *Electrical Characteristics* table 7

Changes from Original (August 2010) to Revision A **Page**

- Switched colors for 10mA and 200mA curves in [Figure 10](#) 8

5 Pin Configuration and Functions

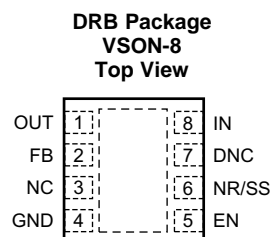
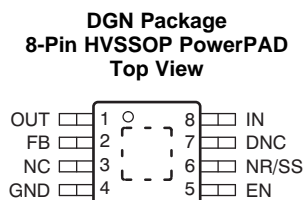

Pin Functions

PIN		I/O	DESCRIPTION
NAME	NO.		
DNC	7	—	Do not connect. Do not route this pin to any electrical net, not even GND or IN.
EN	5	I	This pin turns the regulator on or off. If $V_{EN} \geq V_{EN(+HI, min)}$ or $V_{EN} \leq V_{EN(-HI, max)}$, the regulator is enabled. If $V_{EN(+LO, max)} \geq V_{EN} \geq V_{EN(-LO, min)}$, the regulator is disabled. The EN pin can be connected to IN, if not used. $ V_{EN} \leq V_{IN} $.
FB	2	I	This pin is the feedback pin that sets the output voltage of the device.
GND	4	—	Ground
IN	8	I	Input supply
NC	3	—	Not internally connected. This pin must either be left open or tied to GND.
NR/SS	6	—	Noise reduction pin. Connecting an external capacitor to this pin filters the noise generated by the internal band gap. This capacitor allows RMS noise to be reduced to very low levels and also controls the soft-start function.
OUT	1	O	Regulator output. A capacitor $\geq 2.2 \mu\text{F}$ must be tied from this pin to ground to ensure stability.
PowerPAD	—	—	Must either be left open or tied to GND. Solder to printed-circuit-board (PCB) plane to enhance thermal performance.

6 Specifications

6.1 Absolute Maximum Ratings

over operating free-air temperature range (unless otherwise noted)⁽¹⁾

		MIN	MAX	UNIT
Voltage	IN pin to GND pin	-36	0.3	V
	OUT pin to GND pin	-33	0.3	V
	OUT pin to IN pin	-0.3	36	V
	FB pin to GND pin	-2	0.3	V
	FB pin to IN pin	-0.3	36	V
	EN pin to IN pin	-0.3	36	V
	EN pin to GND pin	-36	36	V
	NR/SS pin to IN pin	-0.3	36	V
	NR/SS pin to GND pin	-2	0.3	V
Current	Peak output	Internally limited		
Temperature	Operating virtual junction, T _J	-40	125	°C
	Storage, T _{stg}	-65	150	°C

(1) Stresses beyond those listed under *Absolute Maximum Ratings* may cause permanent damage to the device. These are stress ratings only, and functional operation of the device at these or any other conditions beyond those indicated is not implied. Exposure to absolute-maximum rated conditions for extended periods may affect device reliability.

6.2 ESD Ratings

		VALUE	UNIT
V _(ESD)	Electrostatic discharge	Human body model (HBM), per ANSI/ESDA/JEDEC JS-001 ⁽¹⁾	±1500
		Charged device model (CDM), per JEDEC specification JESD22-C101 ⁽²⁾	±500

(1) JEDEC document JEP155 states that 500-V HBM allows safe manufacturing with a standard ESD control process.

(2) JEDEC document JEP157 states that 250-V CDM allows safe manufacturing with a standard ESD control process.

TPS7A30

SBVS125D – AUGUST 2010 – REVISED JUNE 2015

www.ti.com

6.3 Recommended Operating Conditions

over operating free-air temperature range (unless otherwise noted)

		MIN	NOM	MAX	UNIT
V_{IN}	Input supply voltage	-35		-3	V
V_{EN}	Enable supply voltage	0		V_{IN}	V
V_{OUT}	Output voltage	V_{REF}		33	V
I_{OUT}	Output current	0		200	mA
T_J	Operating junction temperature	-40		125	°C
C_{IN}	Input capacitor	2.2	10		μF
C_{OUT}	Output capacitor	2.2	10		μF
C_{NR}	Noise reduction capacitor	0	10		nF
C_{FF}	Feed-forward capacitor	0	10		nF
R_2	Lower feedback resistor			237	kΩ

6.4 Thermal Information

THERMAL METRIC ⁽¹⁾	TPS7A30		UNIT	
	DGN (HVSSOP PowerPAD)	DRB (VSON)		
	8 PINS	8 PINS		
$R_{\theta JA}$	Junction-to-ambient thermal resistance	63.4	47.7	°C/W
$R_{\theta JC(top)}$	Junction-to-case(top) thermal resistance	53	55.3	°C/W
$R_{\theta JB}$	Junction-to-board thermal resistance	37.4	23.3	°C/W
Ψ_{JT}	Junction-to-top characterization parameter	3.7	1.1	°C/W
Ψ_{JB}	Junction-to-board characterization parameter	37.1	23.5	°C/W
$R_{\theta JC(bot)}$	Junction-to-case(bottom) thermal resistance	13.5	7.0	°C/W

(1) For more information about traditional and new thermal metrics, see the IC Package Thermal Metrics application report, [SPRA953](#).

6.5 Electrical Characteristics⁽¹⁾

At $T_J = -40^\circ\text{C}$ to 125°C , $|V_{IN}| = |V_{OUT(nom)}| + 1\text{ V}$ or $|V_{IN}| = 3\text{ V}$ (whichever is greater), $V_{EN} = V_{IN}$, $I_{OUT} = 1\text{ mA}$, $C_{IN} = 2.2\text{ }\mu\text{F}$, $C_{OUT} = 2.2\text{ }\mu\text{F}$, $C_{NR/SS} = 0\text{ nF}$, and the FB pin tied to OUT, unless otherwise noted. Typical values are at $T_A = 25^\circ\text{C}$.

PARAMETER		TEST CONDITIONS	MIN	TYP	MAX	UNIT
V_{IN}	Input voltage		-35		-3	V
V_{REF}	Internal reference ⁽²⁾	$T_J = 25^\circ\text{C}$, $V_{NR/SS} = V_{REF}$	-1.202	-1.179	-1.166	V
V_{FB}	Feedback voltage			-1.176		V
V_{OUT}	Output voltage range ⁽³⁾	$ V_{IN} \geq V_{OUT(nom)} + 1\text{ V}$	-33		V_{REF}	V
	Nominal accuracy	$T_J = 25^\circ\text{C}$, $ V_{IN} = V_{OUT(nom)} + 0.5\text{ V}$	-1.5		1.5	% V_{OUT}
	Overall accuracy	$ V_{OUT(nom)} + 1\text{ V} \leq V_{IN} \leq 35\text{ V}$ $1\text{ mA} \leq I_{OUT} \leq 200\text{ mA}$	-2.5		2.5	% V_{OUT}
$\frac{ \Delta V_{OUT}(\Delta V_{IN}) }{V_{OUT(NOM)}}$	Line regulation	$T_J = 25^\circ\text{C}$, $ V_{OUT(nom)} + 1\text{ V} \leq V_{IN} \leq 35\text{ V}$		0.14		% V_{OUT}
$\frac{ \Delta V_{OUT}(\Delta I_{OUT}) }{V_{OUT(NOM)}}$	Load regulation	$T_J = 25^\circ\text{C}$, $1\text{ mA} \leq I_{OUT} \leq 200\text{ mA}$		0.04		% V_{OUT}
$ V_{DO} $	Dropout voltage	$V_{IN} = 95\% V_{OUT(nom)}$, $I_{OUT} = 100\text{ mA}$		216		mV
		$V_{IN} = 95\% V_{OUT(nom)}$, $I_{OUT} = 200\text{ mA}$		325	600	mV
I_{CL}	Current limit	$V_{OUT} = 90\% V_{OUT(nom)}$	220	330	500	mA
I_{GND}	Ground current	$I_{OUT} = 0\text{ mA}$		55	100	μA
		$I_{OUT} = 100\text{ mA}$		950		μA
$ I_{SHDN} $	Shutdown supply current	$V_{EN} = 0.4\text{ V}$		1	3	μA
		$V_{EN} = -0.4\text{ V}$		1	3	μA
I_{FB}	Feedback current ⁽⁴⁾			14	100	nA
$ I_{EN} $	Enable current	$V_{EN} = V_{IN} = V_{OUT(nom)} + 1\text{ V}$		0.48	1	μA
		$V_{IN} = V_{EN} = -35\text{ V}$		0.51	1	μA
		$V_{IN} = -21\text{ V}$, $V_{EN} = 15\text{ V}$		0.5	1	μA
$V_{EN(+HI)}$	Positive enable high-level voltage	$T_J = -40^\circ\text{C}$ to 125°C	2		15	V
		$T_J = -40^\circ\text{C}$ to 85°C	1.8		15	V
$V_{EN(+LO)}$	Positive enable low-level voltage		0		0.4	V
$V_{EN(-HI)}$	Negative enable high-level voltage		V_{IN}		-2	V
$V_{EN(-LO)}$	Negative enable low-level voltage		-0.4		0	V
V_n	Output noise voltage	$V_{IN} = -3\text{ V}$, $V_{OUT(nom)} = V_{REF}$, $C_{OUT} = 10\text{ }\mu\text{F}$, $C_{NR/SS} = 10\text{ nF}$, $BW = 10\text{ Hz}$ to 100 kHz		15.1		μV_{RMS}
		$V_{IN} = -6.2\text{ V}$, $V_{OUT(nom)} = -5\text{ V}$, $C_{OUT} = 10\text{ }\mu\text{F}$, $C_{NR/SS} = C_{FF}^{(5)} = 10\text{ nF}$, $BW = 10\text{ Hz}$ to 100 kHz		17.5		μV_{RMS}
PSRR	Power-supply rejection ratio	$V_{IN} = -6.2\text{ V}$, $V_{OUT(nom)} = -5\text{ V}$, $C_{OUT} = 10\text{ }\mu\text{F}$, $C_{NR/SS} = C_{FF}^{(5)} = 10\text{ nF}$, $f = 120\text{ Hz}$		72		dB
T_{SD}	Thermal shutdown temperature	Shutdown, temperature increasing		170		$^\circ\text{C}$
		Reset, temperature decreasing		150		$^\circ\text{C}$
T_J	Operating junction temperature range		-40		125	$^\circ\text{C}$

(1) At operating conditions, $V_{IN} \leq 0\text{ V}$, $V_{OUT(nom)} \leq V_{REF} \leq 0\text{ V}$. At regulation, $V_{IN} \leq V_{OUT(nom)} - |V_{DO}|$. $I_{OUT} > 0\text{ V}$ flows from OUT to IN.

(2) V_{REF} is measured at the NR/SS pin.

(3) To ensure stability at no load conditions, a current from the feedback resistive network equal to or greater than $5\text{ }\mu\text{A}$ is required.

(4) $I_{FB} > 0\text{ V}$ flows into the device.

(5) C_{FF} refers to a feed-forward capacitor connected to the FB and OUT pins.

6.6 Typical Characteristics

At $T_J = -40^\circ\text{C}$ to 125°C , $|V_{IN}| = |V_{OUT(nom)}| + 1\text{ V}$ or $|V_{IN}| = 3\text{ V}$ (whichever is greater), $V_{EN} = V_{IN}$, $I_{OUT} = 1\text{ mA}$, $C_{IN} = 2.2\ \mu\text{F}$, $C_{OUT} = 2.2\ \mu\text{F}$, $C_{NR/SS} = 0\text{ nF}$, and $V_{OUT} = V_{FB}$, unless otherwise noted. Typical values are at $T_A = 25^\circ\text{C}$.

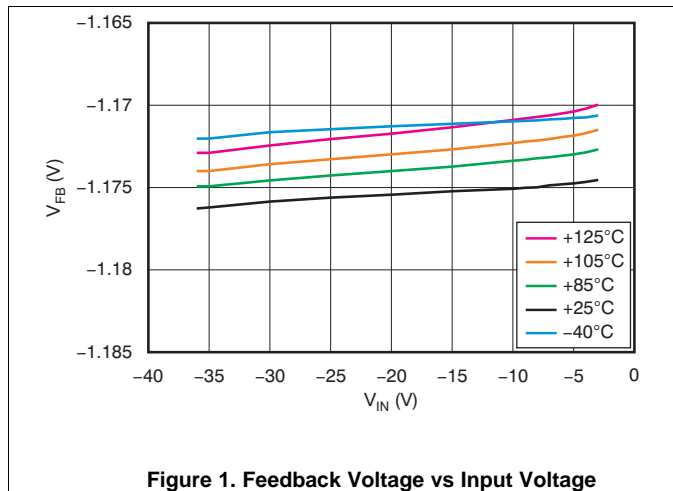

Figure 1. Feedback Voltage vs Input Voltage

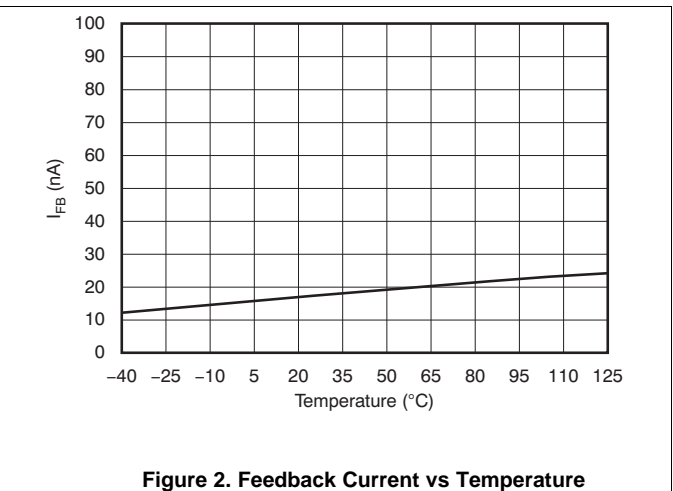

Figure 2. Feedback Current vs Temperature

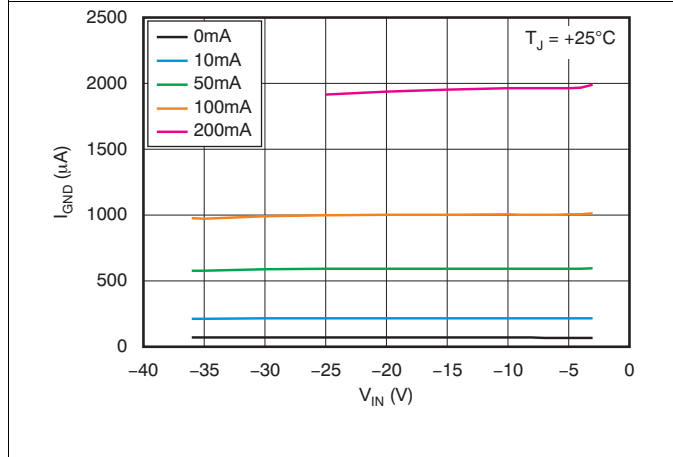

Figure 3. Ground Current vs Input Voltage

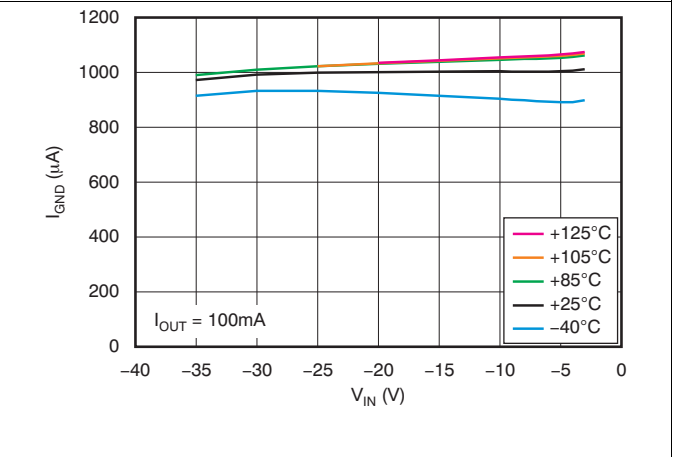

Figure 4. Ground Current vs Input Voltage

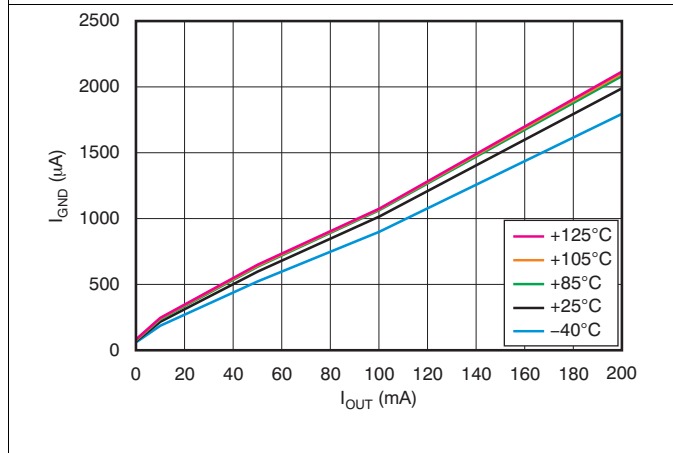

Figure 5. Ground Current vs Output Current

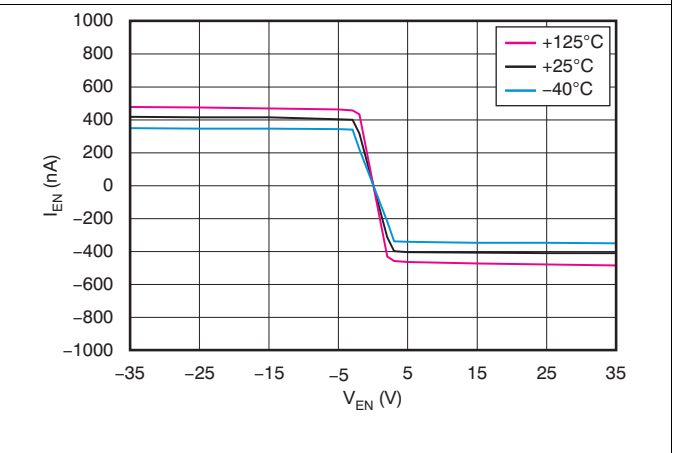

Figure 6. Enable Current vs Enable Voltage

Typical Characteristics (continued)

At $T_J = -40^\circ\text{C}$ to 125°C , $|V_{IN}| = |V_{OUT(nom)}| + 1\text{ V}$ or $|V_{IN}| = 3\text{ V}$ (whichever is greater), $V_{EN} = V_{IN}$, $I_{OUT} = 1\text{ mA}$, $C_{IN} = 2.2\text{ }\mu\text{F}$, $C_{OUT} = 2.2\text{ }\mu\text{F}$, $C_{NR/SS} = 0\text{ nF}$, and $V_{OUT} = V_{FB}$, unless otherwise noted. Typical values are at $T_A = 25^\circ\text{C}$.

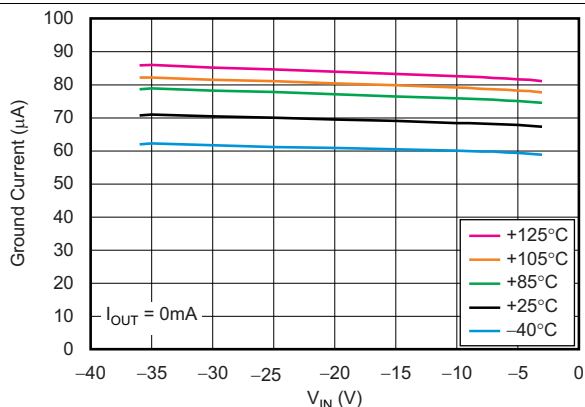

Figure 7. Ground Current vs Input Voltage

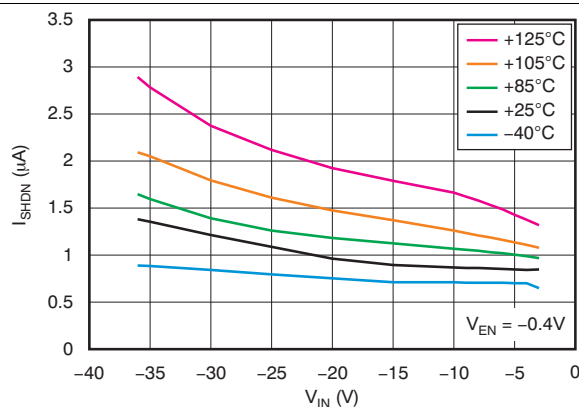

Figure 8. Shutdown Current vs Input Voltage

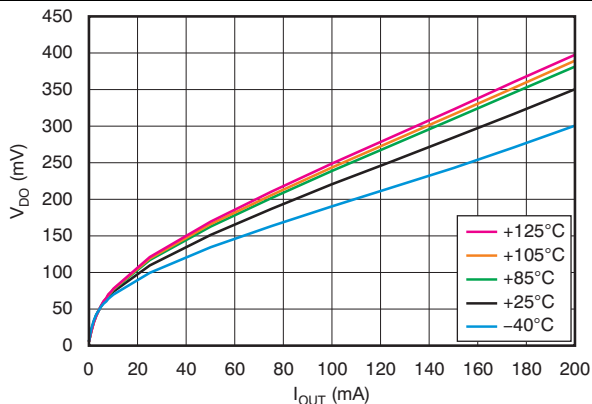

Figure 9. Dropout Voltage vs Output Current

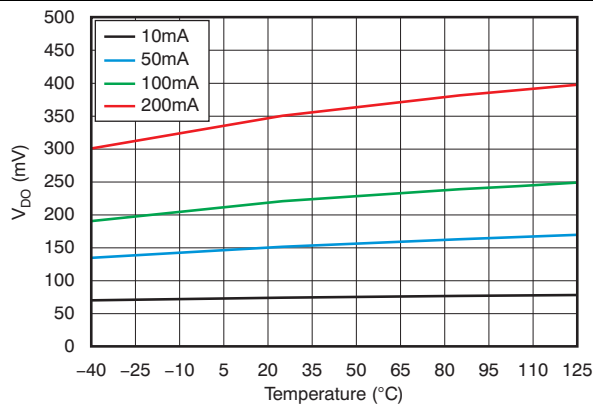

Figure 10. Dropout Voltage vs Temperature

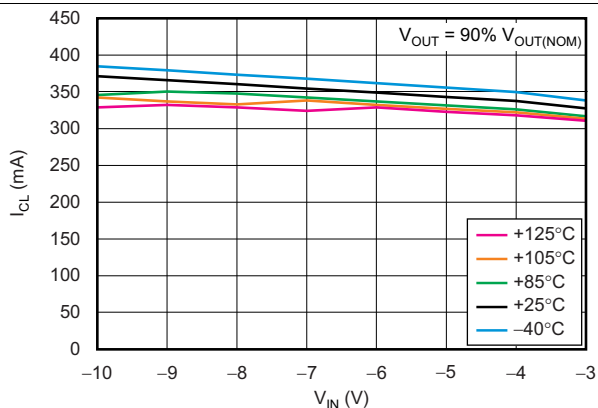

Figure 11. Current Limit vs Input Voltage

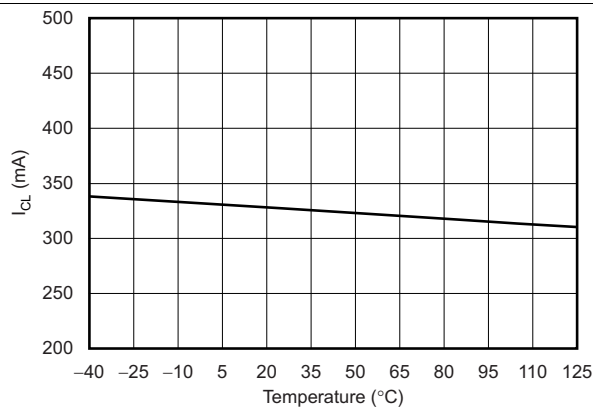

Figure 12. Current Limit vs Temperature

Typical Characteristics (continued)

At $T_J = -40^\circ\text{C}$ to 125°C , $|V_{IN}| = |V_{OUT(nom)}| + 1\text{ V}$ or $|V_{IN}| = 3\text{ V}$ (whichever is greater), $V_{EN} = V_{IN}$, $I_{OUT} = 1\text{ mA}$, $C_{IN} = 2.2\ \mu\text{F}$, $C_{OUT} = 2.2\ \mu\text{F}$, $C_{NR/SS} = 0\text{ nF}$, and $V_{OUT} = V_{FB}$, unless otherwise noted. Typical values are at $T_A = 25^\circ\text{C}$.

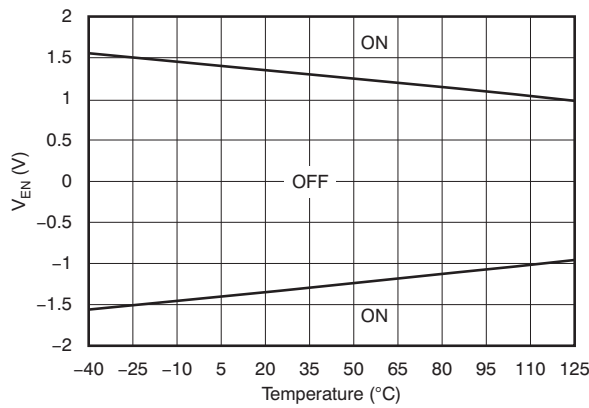

Figure 13. Enable Threshold Voltage vs Temperature

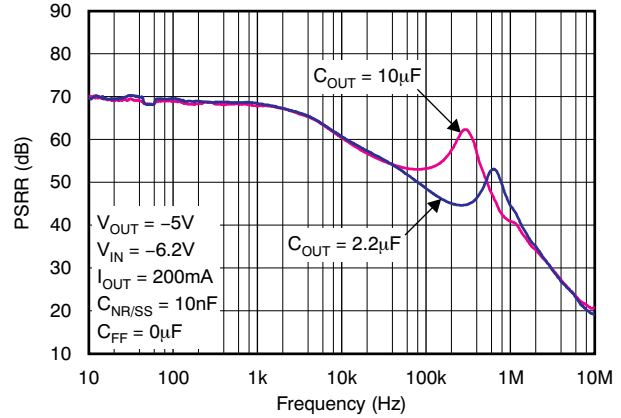

Figure 14. Power-Supply Rejection Ratio vs C_{OUT}

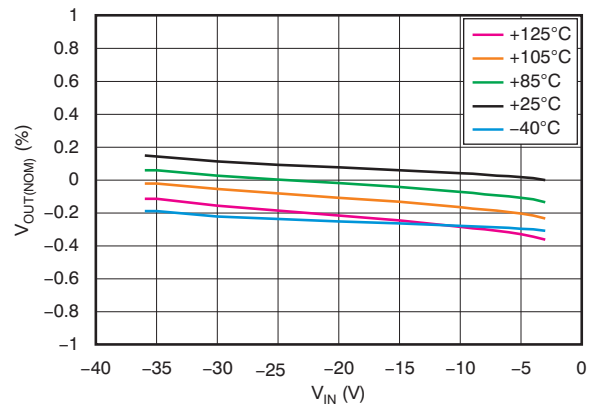

Figure 15. Line Regulation

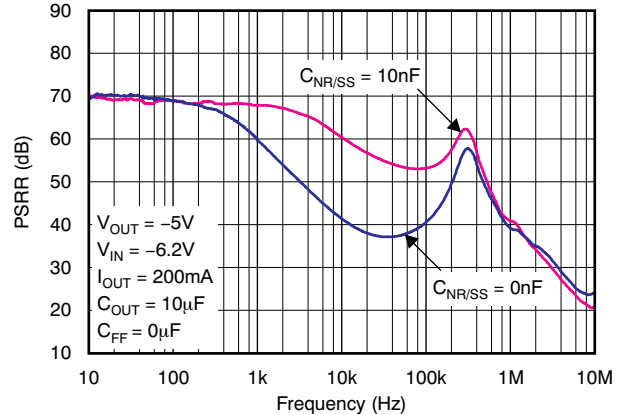

Figure 16. Power-Supply Rejection Ratio vs $C_{NR/SS}$

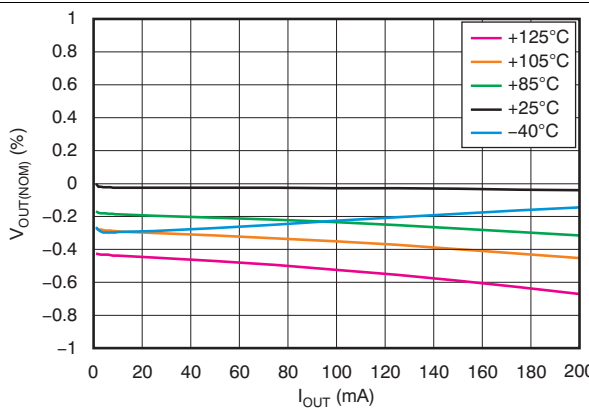

Figure 17. Load Regulation

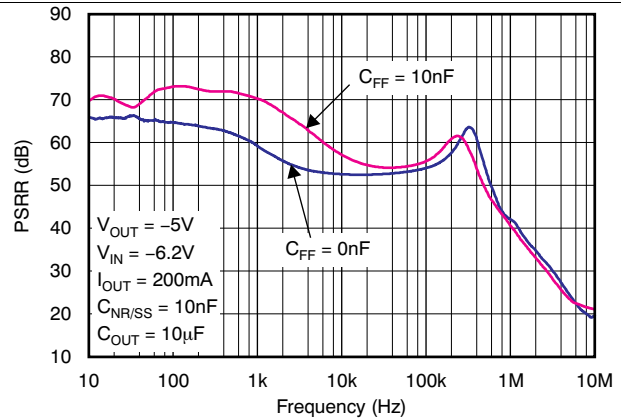

Figure 18. Power-Supply Rejection Ratio vs C_{FF}

Typical Characteristics (continued)

At $T_J = -40^\circ\text{C}$ to 125°C , $|V_{IN}| = |V_{OUT(nom)}| + 1\text{ V}$ or $|V_{IN}| = 3\text{ V}$ (whichever is greater), $V_{EN} = V_{IN}$, $I_{OUT} = 1\text{ mA}$, $C_{IN} = 2.2\ \mu\text{F}$, $C_{OUT} = 2.2\ \mu\text{F}$, $C_{NR/SS} = 0\text{ nF}$, and $V_{OUT} = V_{FB}$, unless otherwise noted. Typical values are at $T_A = 25^\circ\text{C}$.

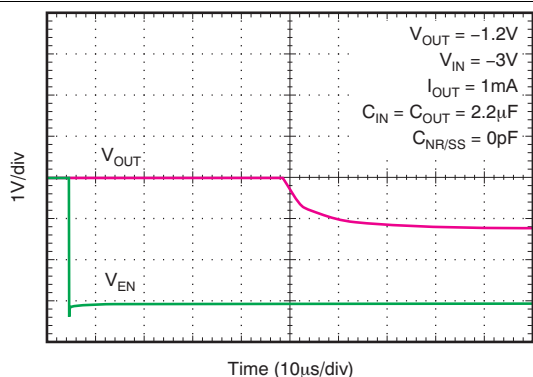

Figure 19. Capacitor-Programmable Soft-Start

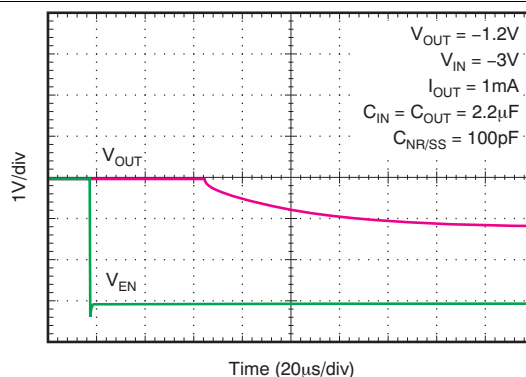

Figure 20. Capacitor-Programmable Soft-Start

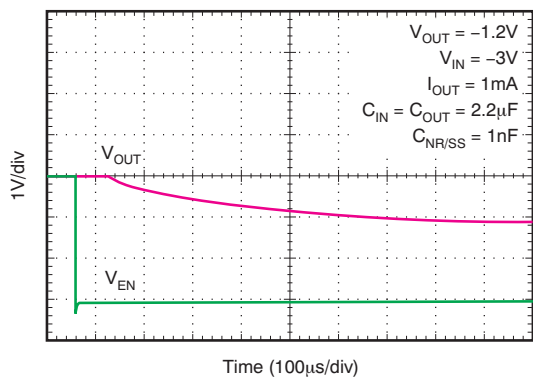

Figure 21. Capacitor-Programmable Soft-Start

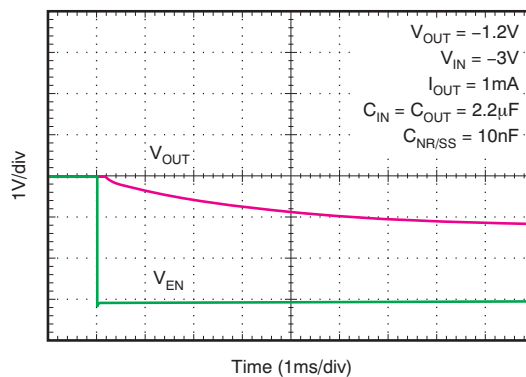

Figure 22. Capacitor-Programmable Soft-Start

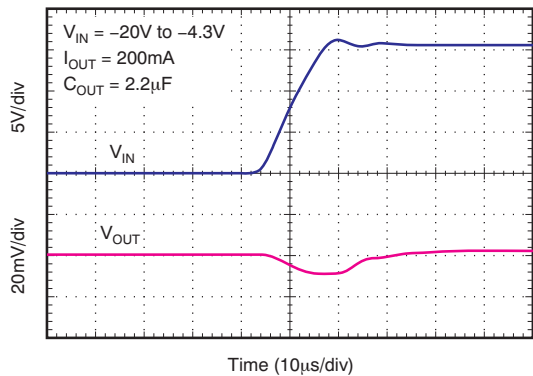

Figure 23. Line Transient Response

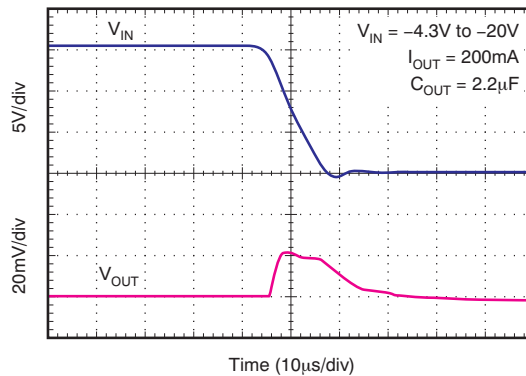

Figure 24. Line Transient Response

Typical Characteristics (continued)

At $T_J = -40^{\circ}\text{C}$ to 125°C , $|V_{IN}| = |V_{OUT(nom)}| + 1\text{ V}$ or $|V_{IN}| = 3\text{ V}$ (whichever is greater), $V_{EN} = V_{IN}$, $I_{OUT} = 1\text{ mA}$, $C_{IN} = 2.2\text{ }\mu\text{F}$, $C_{OUT} = 2.2\text{ }\mu\text{F}$, $C_{NR/SS} = 0\text{ nF}$, and $V_{OUT} = V_{FB}$, unless otherwise noted. Typical values are at $T_A = 25^{\circ}\text{C}$.

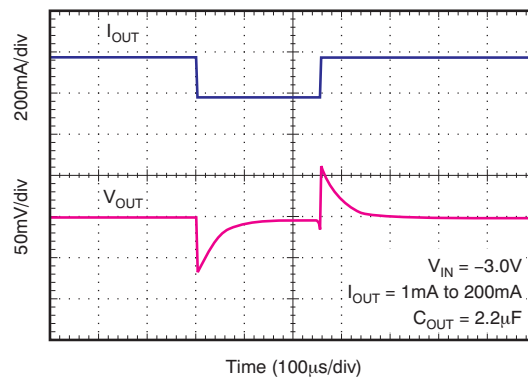
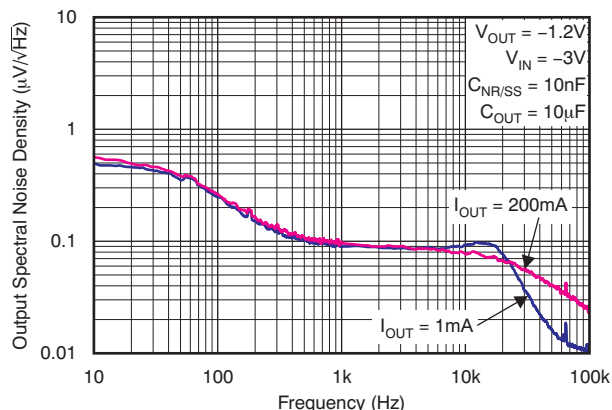

Figure 25. Load Transient Response

7 Parameter Measurement Information



I_{OUT}	RMS NOISE	
	10Hz to 100kHz	100Hz to 100kHz
1mA	15.13	14.73
200mA	17.13	16.71

Figure 26. Output Spectral Noise Density vs Output Current

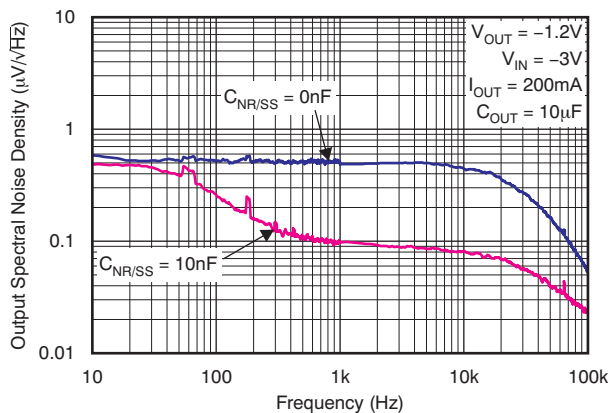

$C_{NR/SS}$	RMS NOISE	
	10Hz to 100kHz	100Hz to 100kHz
0nF	80.00	79.83
10nF	17.29	16.81

Figure 27. Output Spectral Noise Density vs $C_{NR/SS}$

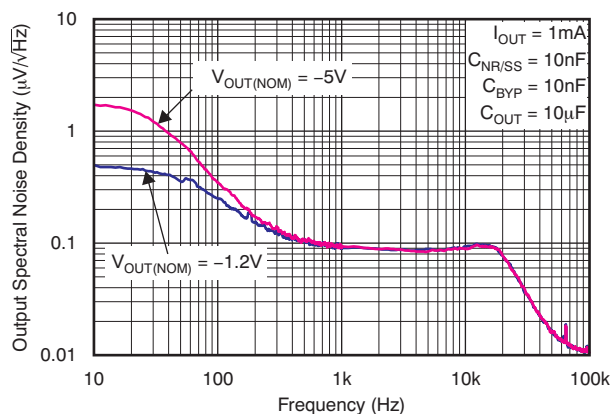

$V_{OUT(NOM)}$	RMS NOISE	
	10Hz to 100kHz	100Hz to 100kHz
-5V	17.50	15.04
-1.2V	15.13	14.73

Figure 28. Output Spectral Noise Density vs $V_{OUT(nom)}$

8 Detailed Description

8.1 Overview

The TPS7A30 family of devices are wide V_{IN} , low-noise, 150-mA linear regulators (LDOs). These devices feature an enable pin, programmable soft-start, current limiting, and thermal protection circuitry that allow the device to be used in a wide variety of applications. As bipolar-based devices, the TPS7A30 devices are ideal for high-accuracy, high-precision applications at higher voltages.

8.2 Functional Block Diagram

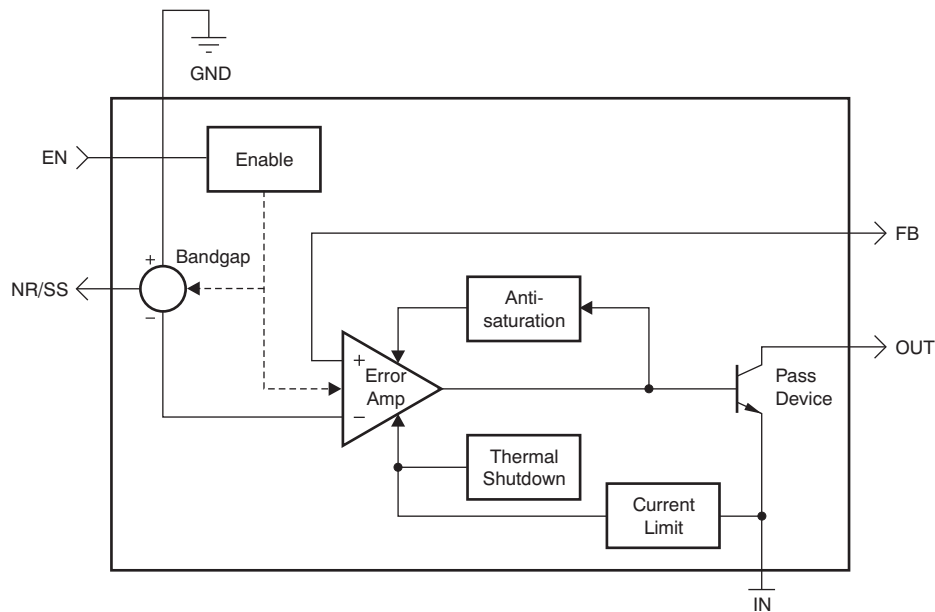

8.3 Feature Description

8.3.1 Internal Current Limit

The fixed internal current limit of the TPS7A30 family helps protect the regulator during fault conditions. The maximum amount of current the device can source is the current limit (330 mA, typical), and is largely independent of the output voltage. For reliable operation, do not operate the device in current limit for extended periods of time.

8.3.2 Programmable Soft-Start

The NR/SS capacitor also functions as a soft-start capacitor to slow down the rise time of the output. The rise time of the output when using an NR/SS capacitor is governed by Equation 1. In Equation 1, t_{SS} is the soft-start time in milliseconds and $C_{NR/SS}$ is the capacitance at the NR pin in nanofarads. Figure 29 shows the relationship between the $C_{NR/SS}$ size and the start-up time without a C_{FF} .

$$t_{SS} \text{ (ms)} = 0.9 \times C_{NR/SS} \text{ (nF)} \tag{1}$$

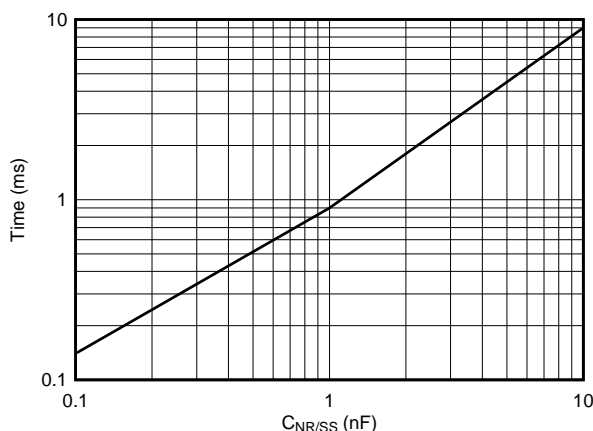

Figure 29. Soft-Start Time vs C_{NR/SS}

8.3.3 Enable Pin Operation

The TPS7A30 provides a dual-polarity enable pin (EN) that turns on the regulator when $|V_{EN}| > 2$ V, whether the voltage is positive or negative, as shown in Figure 30.

This functionality allows for different system power management topologies:

- Connecting the EN pin directly to a negative voltage (such as V_{IN}).
- Connecting the EN pin directly to a positive voltage, such as the output of digital logic circuitry.

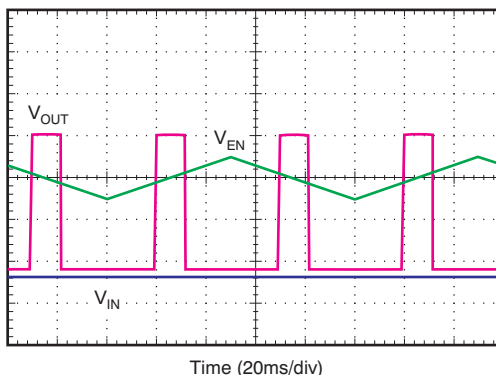

Figure 30. Enable Pin Positive and Negative Threshold

8.4 Device Functional Modes

8.4.1 Normal Operation

The device regulates to the nominal output voltage under the following conditions:

- The input voltage is at least as high as the $|V_{IN(min)}|$.
- The input voltage magnitude is greater than the nominal output voltage magnitude added to the dropout voltage.
- $|V_{EN}| > |V_{(HI)}|$.
- The output current is less than the current limit.
- The device junction temperature is less than the maximum specified junction temperature.

8.4.2 Dropout Operation

If the input voltage magnitude is lower than the nominal output voltage magnitude plus the specified dropout voltage magnitude, but all other conditions are met for normal operation, the device operates in dropout mode. In this mode of operation, the output voltage magnitude is the same as the input voltage magnitude minus the dropout voltage magnitude. The transient performance of the device is significantly degraded because the pass device (such as a bipolar junction transistor, or BJT) is in saturation and no longer controls the current through the LDO. Line or load transients in dropout can result in large output voltage deviations.

8.4.3 Disabled

The device is disabled under the following conditions:

- $|V_{EN}| < |V_{(HI)}|$.
- The device junction temperature is greater than the thermal shutdown temperature.

[Table 1](#) shows the conditions that lead to the different modes of operation.

Table 1. Device Functional Mode Comparison

OPERATING MODE	PARAMETER			
	V_{IN}	V_{EN}	I_{OUT}	T_J
Normal mode	$ V_{IN} > \{ V_{OUT(nom)} + V_{DO} , V_{IN(min)} \}$	$ V_{EN} > V_{(HI)} $	$I_{OUT} < I_{CL}$	$T_J < 125^\circ\text{C}$
Dropout mode	$ V_{IN(min)} < V_{IN} < V_{OUT(nom)} + V_{DO} $	$ V_{EN} > V_{(HI)} $	—	$T_J < 125^\circ\text{C}$
Disabled mode (any true condition disables the device)	—	$ V_{EN} < V_{(LO)} $	—	$T_J > 170^\circ\text{C}$

9 Application and Implementation

NOTE

Information in the following applications sections is not part of the TI component specification, and TI does not warrant its accuracy or completeness. TI's customers are responsible for determining suitability of components for their purposes. Customers should validate and test their design implementation to confirm system functionality.

9.1 Application Information

The TPS7A30 belongs to a family of linear regulators that use an innovative bipolar process to achieve ultralow-noise. The TPS7A30 are bipolar-based devices and are therefore ideal for high-accuracy, high-performance analog applications at higher voltages.

9.1.1 Adjustable Operation

The TPS7A3001 has an output voltage range of -1.174 V to -33 V . The nominal output voltage of the device is set by two external resistors; see [Figure 32](#).

R_1 and R_2 can be calculated for any output voltage range using the formula shown in [Equation 2](#). To ensure stability under no load conditions, this resistive network must provide a current equal to or greater than $5\text{ }\mu\text{A}$.

$$R_1 = R_2 \left(\frac{V_{\text{OUT}}}{V_{\text{FB(nom)}}} - 1 \right), \text{ where } \frac{|V_{\text{FB(nom)}}|}{R_2} > 5\text{ }\mu\text{A} \quad (2)$$

If greater voltage accuracy is required, take into account the output voltage offset contributions resulting from the feedback pin current and use 0.1% tolerance resistors. [Table 2](#) shows the 1% resistor values for several different standard output voltages.

Table 2. Standard 1% Resistor Values for Various Output Voltages

$V_{\text{OUT}}\text{ (V)}$	$R_1\text{ (k}\Omega\text{)}$	$R_2\text{ (k}\Omega\text{)}$
-2.5	11.3	10
-5	32.4	10
-12	93.1	10
-15	118	10
-18	143	10

9.1.2 Capacitor Recommendations

Use low-equivalent series resistance (ESR) capacitors for the input, output, noise reduction, and feed-forward capacitors. Ceramic capacitors with X7R and X5R dielectrics are preferred. Ceramic X7R capacitors offer improved overtemperature performance, whereas ceramic X5R capacitors are the most cost-effective and are available in higher values.

NOTE

High-ESR capacitors can degrade PSRR.

9.1.2.1 Input and Output Capacitor Requirements

The TPS7A30 family of negative, high-voltage linear regulators achieve stability with a minimum input and output capacitance of 2.2 μF ; however, TI highly recommends using a 10- μF capacitor to maximize ac performance.

9.1.2.2 Noise-Reduction and Feed-Forward Capacitor Requirements

Although noise-reduction and feed-forward capacitors ($C_{\text{NR/SS}}$ and C_{FF} , respectively) are not needed to achieve stability, TI highly recommends using 10-nF capacitors to minimize noise and maximize ac performance.

For more information on C_{FF} , refer to application report, *Pros and Cons of Using a Feedforward Capacitor with a Low-Dropout Regulator* (SBVA042). This application report explains the advantages of using C_{FF} (also known as C_{BYP}), and the problems that can occur when using this capacitor.

9.1.3 Maximum AC Performance

To maximize noise and PSRR performance, TI recommends including a 10- μF or higher input and output capacitors, and 10-nF noise-reduction and bypass capacitors; see Figure 32. The solution illustrated in Figure 32 delivers minimum noise levels of 15.1 μV_{RMS} and power-supply rejection levels above 55 dB from 10 Hz to 700 kHz; see Figure 18 and Figure 26.

9.1.4 Output Noise

The TPS7A30 provides low output noise when a noise-reduction capacitor ($C_{\text{NR/SS}}$) is used.

The noise-reduction capacitor serves as a filter for the internal reference. By using a 10-nF noise reduction capacitor, the output noise is reduced by approximately 80% (from 80 μV_{RMS} to 17 μV_{RMS}); see Figure 27.

The TPS7A30 low output voltage noise makes the device an ideal solution for powering noise-sensitive circuitry.

9.1.5 Power-Supply Rejection

The 10-nF noise-reduction capacitor greatly improves TPS7A30 power-supply rejection, achieving up to 20 dB of additional power-supply rejection for frequencies between 110 Hz and 400 kHz.

Additionally, ac performance can be maximized by adding a 10-nF bypass capacitor (C_{FF}) from the FB pin to the OUT pin. This capacitor greatly improves power-supply rejection at lower frequencies, for the band from 10 Hz to 200 kHz; see Figure 18.

The very high power-supply rejection of the TPS7A30 makes the device a good choice for powering high-performance analog circuitry (such as operational amplifiers, ADCs, DACs, and audio amplifiers).

9.1.6 Transient Response

As with any regulator, increasing the size of the output capacitor reduces overshoot and undershoot magnitude but increases duration of the transient response.

9.1.7 Post DC-DC Converter Filtering

Most of the time, the voltage rails available in a system do not match the voltage requirements for the system. These rails must be stepped up or down, depending on specific voltage requirements.

DC-DC converters are the preferred solution to step up or down a voltage rail when current consumption is not negligible. These converters offer high efficiency with minimum heat generation, but have one primary disadvantage: these converters introduce a high-frequency component (and the associated harmonics) in addition to the dc output signal.

This high-frequency component, if not filtered properly, degrades analog circuitry performance, reducing overall system accuracy and precision.

The TPS7A30 offers a wide-bandwidth, very-high power-supply rejection ratio. This specification makes the device ideal for post dc-dc converter filtering; see Figure 31. TI highly recommends using the maximum performance schematic illustrated in Figure 32. Also, verify that the fundamental frequency (and its first harmonic, if possible) is within the bandwidth of the regulator PSRR; see Figure 18.

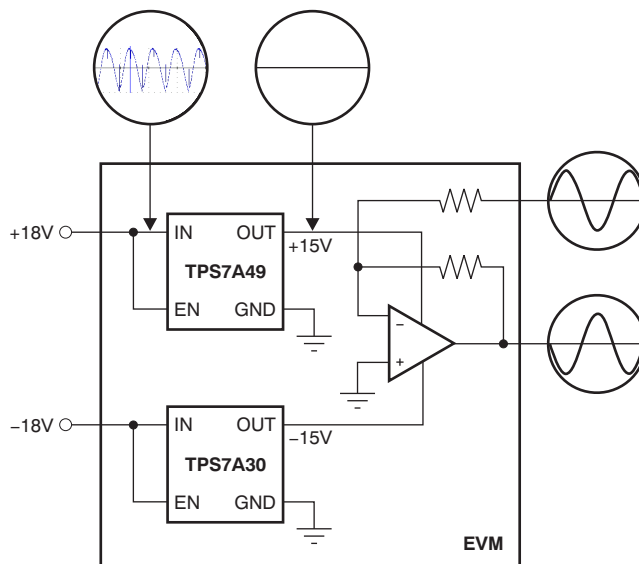

Figure 31. Post DC-DC Converter Regulation to High-Performance Analog Circuitry

9.1.8 Audio Applications

Audio applications are extremely sensitive to any distortion and noise in the audio band from 20 Hz to 20 kHz. This stringent requirement demands clean voltage rails to power critical high-performance audio systems.

The very-high power-supply rejection ratio (> 55 dB) and low noise at the audio band of the TPS7A30 maximize performance for audio applications; see [Figure 18](#).

9.1.9 Power for Precision Analog

One of the primary TPS7A30 applications is to provide ultralow noise voltage rails to high-performance analog circuitry in order to maximize system accuracy and precision.

In conjunction with its positive counterpart, the [TPS7A49xx](#) family of positive high-voltage linear regulators, the TPS7A30 family of negative high voltage linear regulators provides ultralow noise positive and negative voltage rails to high-performance analog circuitry (such as operational amplifiers, ADCs, DACs, and audio amplifiers).

The low noise levels at high voltages, such as ± 15 V, enables clean power rails for precision analog circuitry. This characteristic allows for high-performance analog solutions to optimize the voltage range, thus maximizing system accuracy.

9.2 Typical Application

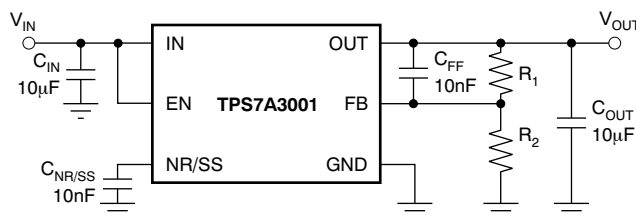

Figure 32. Adjustable Operation for Maximum AC Performance

9.2.1 Design Requirements

The design goals are $V_{IN} = -3\text{ V}$, $V_{OUT} = -1.2\text{ V}$, and $I_{OUT} = 150\text{ mA}$, maximum. The design must optimize transient response and meet a start-up time of 14 ms. The input supply comes from a supply on the same printed circuit board (PCB). The design circuit is shown in [Figure 32](#).

The design space consists of C_{IN} , C_{OUT} , $C_{NR/SS}$, R_1 , and R_2 , at $T_{A(max)} = 75^\circ\text{C}$.

9.2.2 Detailed Design Procedure

The first step when designing with a linear regulator is to examine the maximum load current, along with the input and output voltage requirements, to determine if the device thermal and dropout voltage requirements can be met. At 150 mA, the input dropout voltage of the TPS7A30 family is a maximum of 600 mV overtemperature; therefore, the dropout headroom of 1.8 V is sufficient for operation over both input and output voltage accuracy. Dropout headroom is calculated as $V_{IN} - V_{OUT} - V_{DO(max)}$, and must be greater than 0 V for reliable operation. $V_{DO(max)}$ is the maximum dropout allowed, given worst-case load conditions.

The maximum power dissipated in the linear regulator is the maximum voltage dropped across the pass element from the input to the output, multiplied by the maximum load current. In this example, the maximum voltage drop across in the pass element is $|3\text{ V} - 1.2\text{ V}|$, resulting in $V_{IN} - V_{OUT} = 1.8\text{ V}$. The power dissipated in the pass element is calculated by taking this voltage drop multiplied by the maximum load current. For this example, the maximum power dissipated in the linear regulator is 0.273 W, and is calculated as [Equation 3](#):

$$P_D = (V_{IN} - V_{OUT}) (I_{MAX}) + (V_{IN}) (I_Q) \quad (3)$$

When the power dissipated in the linear regulator is known, the corresponding junction temperature rise can be calculated. To calculate the junction temperature rise above ambient, the power dissipated must be multiplied by the junction-to-ambient thermal resistance. This calculation gives the worst-case junction temperature; good thermal design can significantly reduce this number. For thermal resistance information, refer to the [Thermal Information](#) table. For this example, using the DGN package, the maximum junction temperature rise is calculated to be 17.3°C . The maximum junction temperature rise is calculated by adding the junction temperature rise to the maximum ambient temperature, which is 75°C for this example. For this example, calculate the maximum junction temperature as 92.3°C . Keep in mind that the maximum junction temperature must be below 125°C for reliable device operation. Additional ground planes, added thermal vias, and air flow all help to lower the maximum junction temperature.

Use the following equations to select the rest of the components:

To ensure stability under no-load conditions, the current through the resistor network must be greater than $5\text{ }\mu\text{A}$, as shown in [Equation 4](#).

$$\frac{V_{FB}}{R_2} > 5\text{ }\mu\text{A} \rightarrow R_2 < 242.4\text{ k}\Omega \quad (4)$$

To set $R_2 = 100\text{ k}\Omega$ for a standard 1% value resistor, calculate R_1 as shown in [Equation 5](#).

$$R_1 = R_2 \left(\frac{V_{OUT}}{V_{REF(nom)}} - 1 \right) = 100\text{ k}\Omega \left(\frac{1.2\text{ V}}{1.176\text{ V}} - 1 \right) = 2.04\text{ k}\Omega \quad (5)$$

Use a standard, 1%, 2.05-k Ω resistor for R_1 .

Typical Application (continued)

Equation 6 calculates the start-up time, t_{SS} .

$$t_{SS} \text{ (ms)} = 0.9 \times C_{NR/SS} = 14 \text{ ms}$$

$$C_{SS} = 15 \text{ nF} \tag{6}$$

For the soft-start to dominate the start-up conditions, ideally place the start-up time as a result of the current limit at two decades below the soft-start time (at 140 μs). C_{OUT} must be at least 2.2 μF for stability, as shown in Equation 7 and Equation 8.

$$t_{SS(CL)} = V_{OUT} \left(\frac{C_{OUT}}{I_{CL(max)}} \right) \tag{7}$$

$$C_{OUT(max)} = t_{SS(CL)} \left(\frac{I_{CL(min)}}{V_{OUT}} \right) = 140 \mu\text{s} \times \frac{220 \text{ mA}}{2 \text{ V}} = 15.4 \mu\text{F} \tag{8}$$

For C_{IN} , assume that the -3-V supply has some inductance and is placed several inches away from the PCB. For this case, select a 2.2- μF ceramic input capacitor to ensure that the input impedance is negligible to the LDO control loop and to keep the physical size and cost of the capacitor low; this component is a common-value capacitor.

For better PSRR for this design, use a 10- μF input and output capacitor. To reduce the peaks from transients but slow down the recovery time, increase the output capacitor size or add additional output capacitors.

Typical Application (continued)

9.2.3 Application Curves

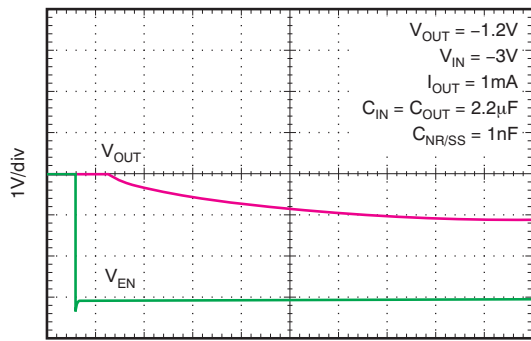

Time (100µs/div)

Figure 33. Capacitor-Programmable Soft-Start

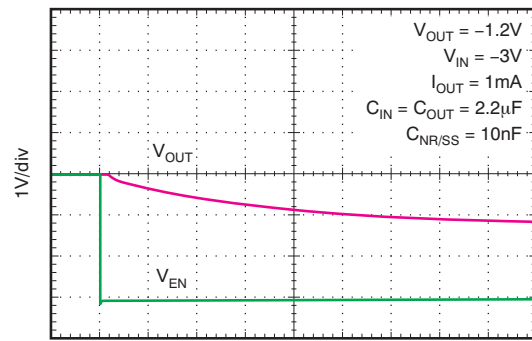

Time (1ms/div)

Figure 34. Capacitor-Programmable Soft-Start

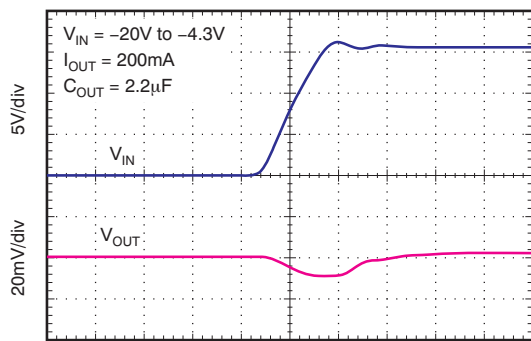

Time (10µs/div)

Figure 35. Line Transient Response

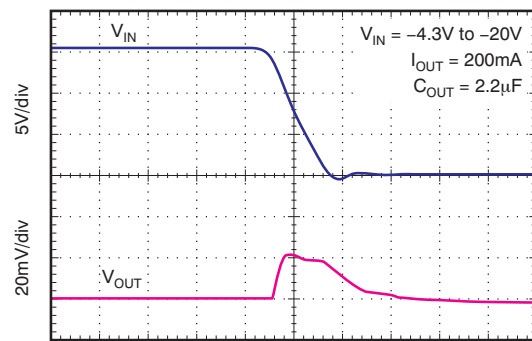

Time (10µs/div)

Figure 36. Line Transient Response

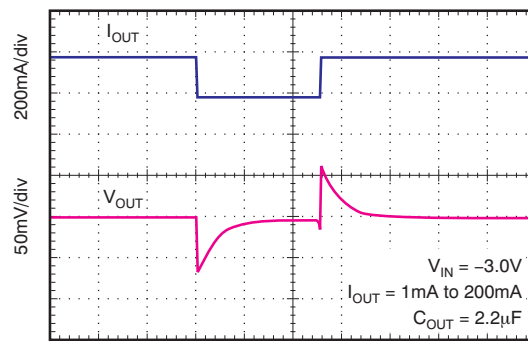

Time (100µs/div)

Figure 37. Load Transient Response

9.3 Do's and Don'ts

Place at least one low-ESR, 2.2- μ F capacitor as close as possible to both the IN and OUT pins of the regulator to the GND pin.

Provide adequate thermal paths away from the device.

Do not place the input or output capacitor more than 10 mm away from the regulator.

Do not exceed the absolute maximum ratings.

Do not float the enable (EN) pin.

Do not resistively or inductively load the NR/SS pin.

10 Power Supply Recommendations

The input supply for the LDO must be within the recommended operating conditions (that is, between -3 V and -35 V). The input voltage must provide adequate headroom in order for the device to have a regulated output. If the input supply is noisy, additional input capacitors with low ESR can help improve the output noise performance.

The input and output supplies must also be bypassed with at least a 2.2- μ F capacitor located near the input and output pins. There must be no other components located between these capacitors and the pins.

11 Layout

11.1 Layout Guidelines

Layout is a critical part of good power-supply design. There are several signal paths that conduct fast-changing currents or voltages that can interact with stray inductance or parasitic capacitance to generate noise or degrade the power-supply performance. To help eliminate these problems, the IN pin must be bypassed to ground with a low ESR ceramic bypass capacitor with an X5R or X7R dielectric.

The GND pin must be tied directly to the PowerPAD under the device. The PowerPAD must be connected to any internal PCB ground planes using multiple vias directly under the device.

Equivalent series inductance (ESL) and equivalent series resistance (ESR) must be minimized to maximize performance and ensure stability. Every capacitor (C_{IN} , C_{OUT} , $C_{NR/SS}$, and C_{FF}) must be placed as close as possible to the device and on the same side of the PCB as the regulator itself.

Do not place any of the capacitors on the opposite side of the PCB from where the regulator is installed. The use of vias and long traces is strongly discouraged because these circuits can negatively affect system performance, and can even cause instability.

11.1.1 Board Layout Recommendations to Improve PSRR and Noise Performance

To improve ac performance (such as PSRR, output noise, and transient response), TI recommends designing the board with separate ground planes for V_{IN} and V_{OUT} , with each ground plane star-connected only at the GND pin of the device. In addition, the ground connection for the bypass capacitor must connect directly to the GND pin of the device.

11.2 Layout Examples

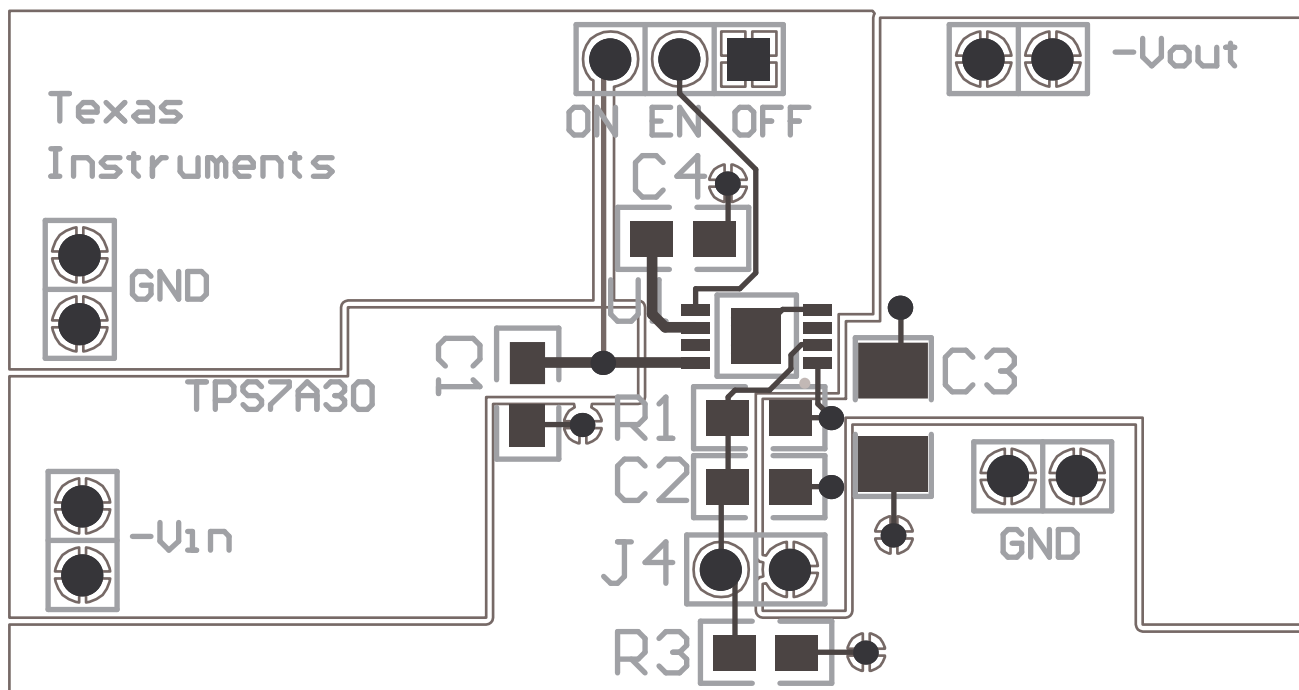

Figure 38. PCB Layout Example

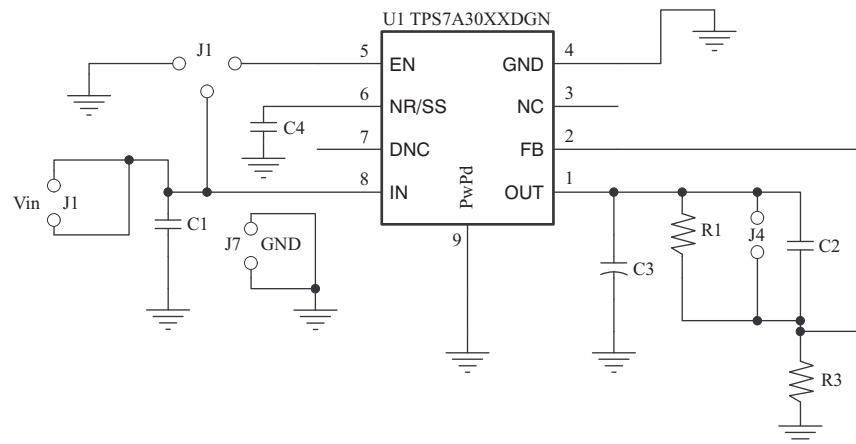
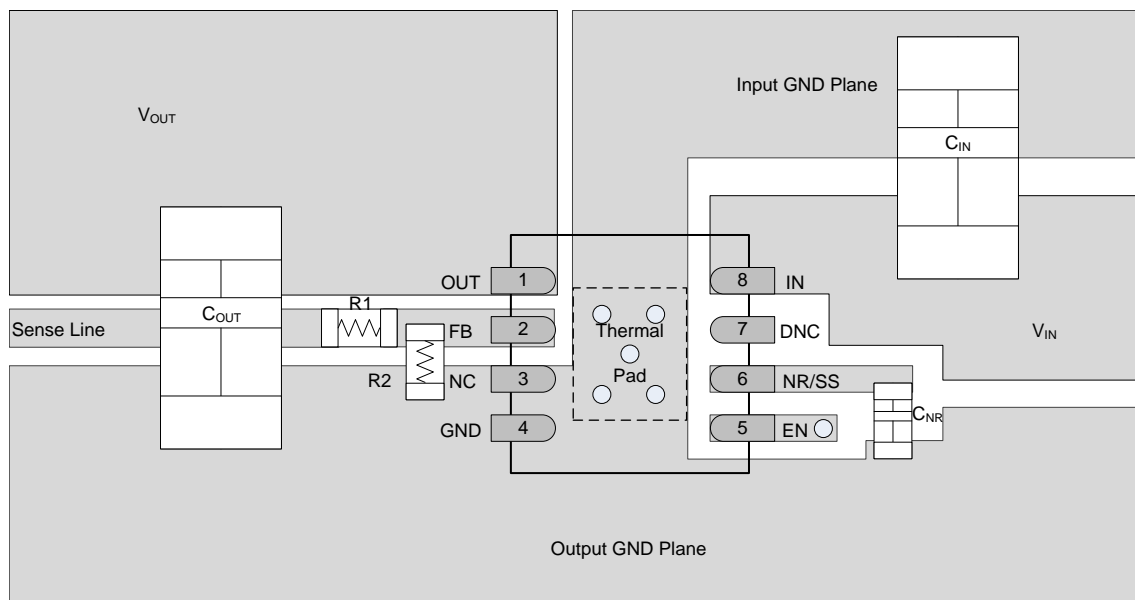

Figure 39. PCB Layout Example Schematic



NOTE: C_{IN} and C_{OUT} are size 1206 capacitors, and C_{NR} , R_1 , and R_2 are size 0402.

Figure 40. PCB Layout Example

11.3 Thermal Considerations

Thermal protection disables the output when the junction temperature rises to approximately 170°C, allowing the device to cool. When the junction temperature cools to approximately 150°C, the output circuitry is enabled. Depending on power dissipation, thermal resistance, and ambient temperature, the thermal protection circuit can cycle on and off. This cycling limits the dissipation of the regulator, protecting it from damage as a result of overheating.

Any tendency to activate the thermal protection circuit indicates excessive power dissipation or an inadequate heatsink. For reliable operation, junction temperature must be limited to a maximum of 125°C. To estimate the margin of safety in a complete design (including heatsink), increase the ambient temperature until the thermal protection is triggered; use worst-case loads and signal conditions. For good reliability, thermal protection must trigger at least 45°C above the maximum expected ambient condition of any particular application. This configuration produces a worst-case junction temperature of 125°C at the highest expected ambient temperature and worst-case load.

The internal protection circuitry of the TPS7A30 is designed to protect against overload conditions. This circuitry is not intended to replace proper heatsinking. Continuously running the TPS7A30 into thermal shutdown degrades device reliability.

11.4 Power Dissipation

The ability to remove heat from the die is different for each package type, presenting different considerations in the PCB layout. The PCB area around the device that is free of other components moves the heat from the device to the ambient air. Performance data or JEDEC low- and high-K boards are provided in the [Thermal Information](#) table. Using heavier copper increases the effectiveness in removing heat from the device. The addition of plated through-holes to heat dissipating layers also improves the heatsink effectiveness.

Power dissipation depends on input voltage and load conditions. Power dissipation (P_D) can be approximated by the product of the output current times the voltage drop across the output pass element, as shown in [Equation 9](#).

$$P_D = (V_{IN} - V_{OUT}) I_{OUT} \quad (9)$$

Power Dissipation (continued)

Estimating the junction temperature can be done by using the thermal metrics Ψ_{JT} and Ψ_{JB} , as discussed in the [Thermal Information](#) table. These metrics are a more accurate representation of the heat transfer characteristics of the die and the package than $R_{\theta JA}$. The junction temperature can be estimated with [Equation 10](#).

$$\Psi_{JT}: T_J = T_T + \Psi_{JT} \cdot P_D$$

$$\Psi_{JB}: T_J = T_B + \Psi_{JB} \cdot P_D$$

where

- P_D is the power dissipation given by [Equation 9](#),
 - T_T is the temperature at the center-top of the device package, and
 - T_B is the PCB temperature measured 1 mm away from the device package on the PCB surface. (10)
-

NOTE

Both T_T and T_B can be measured on actual application boards using a thermo-gun (an infrared thermometer).

For more information about measuring T_T and T_B , see the application note *Using New Thermal Metrics* ([SBVA025](#)), available for download at www.ti.com.

12 Device and Documentation Support

12.1 Device Support

12.1.1 Development Support

12.1.1.1 Evaluation Modules

An evaluation module (EVM) is available to assist in the initial circuit performance evaluation using the TPS7A30. The [TPS7A30-49EVM-567 evaluation module](#) (and [related user's guide](#)) can be requested at the TI website through the product folders or purchased directly from the [TI eStore](#).

12.1.1.2 Spice Models

Computer simulation of circuit performance using SPICE is often useful when analyzing the performance of analog circuits and systems. A SPICE model for the TPS7A30 is available through the product folders under the *Tools & Software* tab.

12.1.2 Device Nomenclature

Table 3. Ordering Information⁽¹⁾

PRODUCT	V _{OUT}
TPS7A30xx yyy z	XX is nominal output voltage (01 = Adjustable). ⁽²⁾ YYY is package designator. Z is package quantity.

(1) For the most current package and ordering information see the Package Option Addendum at the end of this document, or visit the device product folder on www.ti.com.

(2) For fixed –1.2-V operation, tie FB to OUT.

12.2 Documentation Support

12.2.1 Related Documentation

For related documentation see the following:

- *Pros and Cons of Using a Feedforward Capacitor with a Low-Dropout Regulator*, [SBVA042](#).
- *Using New Thermal Metrics*, [SBVA025](#)
- *TPS7A30-49EVM-567 Evaluation Module User's Guide*, [SLVU405](#)

12.3 Community Resources

The following links connect to TI community resources. Linked contents are provided "AS IS" by the respective contributors. They do not constitute TI specifications and do not necessarily reflect TI's views; see TI's [Terms of Use](#).

TI E2E™ Online Community *TI's Engineer-to-Engineer (E2E) Community*. Created to foster collaboration among engineers. At e2e.ti.com, you can ask questions, share knowledge, explore ideas and help solve problems with fellow engineers.

Design Support *TI's Design Support* Quickly find helpful E2E forums along with design support tools and contact information for technical support.

12.4 Trademarks

PowerPAD, E2E are trademarks of Texas Instruments.
All other trademarks are the property of their respective owners.

12.5 Electrostatic Discharge Caution



These devices have limited built-in ESD protection. The leads should be shorted together or the device placed in conductive foam during storage or handling to prevent electrostatic damage to the MOS gates.

12.6 Glossary

[SLYZ022](#) — *TI Glossary*.

This glossary lists and explains terms, acronyms, and definitions.

13 Mechanical, Packaging, and Orderable Information

The following pages include mechanical, packaging, and orderable information. This information is the most current data available for the designated devices. This data is subject to change without notice and revision of this document. For browser-based versions of this data sheet, refer to the left-hand navigation.

PACKAGING INFORMATION

Orderable Device	Status (1)	Package Type	Package Drawing	Pins	Package Qty	Eco Plan (2)	Lead finish/ Ball material (6)	MSL Peak Temp (3)	Op Temp (°C)	Device Marking (4/5)	Samples
TPS7A3001DGNR	ACTIVE	HVSSOP	DGN	8	2500	RoHS & Green	NIPDAU	Level-2-260C-1 YEAR	-40 to 125	PSZQ	Samples
TPS7A3001DGNT	ACTIVE	HVSSOP	DGN	8	250	RoHS & Green	NIPDAU	Level-2-260C-1 YEAR	-40 to 125	PSZQ	Samples
TPS7A3001DRBR	ACTIVE	SON	DRB	8	3000	RoHS & Green	NIPDAU	Level-2-260C-1 YEAR	-40 to 125	PSZQ	Samples
TPS7A3001DRBT	ACTIVE	SON	DRB	8	250	RoHS & Green	NIPDAU	Level-2-260C-1 YEAR	-40 to 125	PSZQ	Samples

(1) The marketing status values are defined as follows:

ACTIVE: Product device recommended for new designs.

LIFEBUY: TI has announced that the device will be discontinued, and a lifetime-buy period is in effect.

NRND: Not recommended for new designs. Device is in production to support existing customers, but TI does not recommend using this part in a new design.

PREVIEW: Device has been announced but is not in production. Samples may or may not be available.

OBSOLETE: TI has discontinued the production of the device.

(2) **RoHS:** TI defines "RoHS" to mean semiconductor products that are compliant with the current EU RoHS requirements for all 10 RoHS substances, including the requirement that RoHS substance do not exceed 0.1% by weight in homogeneous materials. Where designed to be soldered at high temperatures, "RoHS" products are suitable for use in specified lead-free processes. TI may reference these types of products as "Pb-Free".

RoHS Exempt: TI defines "RoHS Exempt" to mean products that contain lead but are compliant with EU RoHS pursuant to a specific EU RoHS exemption.

Green: TI defines "Green" to mean the content of Chlorine (Cl) and Bromine (Br) based flame retardants meet JS709B low halogen requirements of <=1000ppm threshold. Antimony trioxide based flame retardants must also meet the <=1000ppm threshold requirement.

(3) **MSL, Peak Temp.** - The Moisture Sensitivity Level rating according to the JEDEC industry standard classifications, and peak solder temperature.

(4) There may be additional marking, which relates to the logo, the lot trace code information, or the environmental category on the device.

(5) Multiple Device Markings will be inside parentheses. Only one Device Marking contained in parentheses and separated by a "-" will appear on a device. If a line is indented then it is a continuation of the previous line and the two combined represent the entire Device Marking for that device.

(6) **Lead finish/Ball material** - Orderable Devices may have multiple material finish options. Finish options are separated by a vertical ruled line. Lead finish/Ball material values may wrap to two lines if the finish value exceeds the maximum column width.

Important Information and Disclaimer: The information provided on this page represents TI's knowledge and belief as of the date that it is provided. TI bases its knowledge and belief on information provided by third parties, and makes no representation or warranty as to the accuracy of such information. Efforts are underway to better integrate information from third parties. TI has taken and

continues to take reasonable steps to provide representative and accurate information but may not have conducted destructive testing or chemical analysis on incoming materials and chemicals. TI and TI suppliers consider certain information to be proprietary, and thus CAS numbers and other limited information may not be available for release.

In no event shall TI's liability arising out of such information exceed the total purchase price of the TI part(s) at issue in this document sold by TI to Customer on an annual basis.

TAPE AND REEL INFORMATION

QUADRANT ASSIGNMENTS FOR PIN 1 ORIENTATION IN TAPE

*All dimensions are nominal

Device	Package Type	Package Drawing	Pins	SPQ	Reel Diameter (mm)	Reel Width W1 (mm)	A0 (mm)	B0 (mm)	K0 (mm)	P1 (mm)	W (mm)	Pin1 Quadrant
TPS7A3001DGNR	HVSSOP	DGN	8	2500	330.0	12.4	5.3	3.4	1.4	8.0	12.0	Q1
TPS7A3001DGNT	HVSSOP	DGN	8	250	180.0	12.4	5.3	3.4	1.4	8.0	12.0	Q1
TPS7A3001DRBR	SON	DRB	8	3000	330.0	12.4	3.3	3.3	1.1	8.0	12.0	Q2
TPS7A3001DRBT	SON	DRB	8	250	180.0	12.4	3.3	3.3	1.1	8.0	12.0	Q2

TAPE AND REEL BOX DIMENSIONS

*All dimensions are nominal

Device	Package Type	Package Drawing	Pins	SPQ	Length (mm)	Width (mm)	Height (mm)
TPS7A3001DGNR	HVSSOP	DGN	8	2500	853.0	449.0	35.0
TPS7A3001DGNT	HVSSOP	DGN	8	250	210.0	185.0	35.0
TPS7A3001DRBR	SON	DRB	8	3000	367.0	367.0	35.0
TPS7A3001DRBT	SON	DRB	8	250	210.0	185.0	35.0

DRB 8

GENERIC PACKAGE VIEW

VSON - 1 mm max height

PLASTIC SMALL OUTLINE - NO LEAD



Images above are just a representation of the package family, actual package may vary.
Refer to the product data sheet for package details.

4203482/L

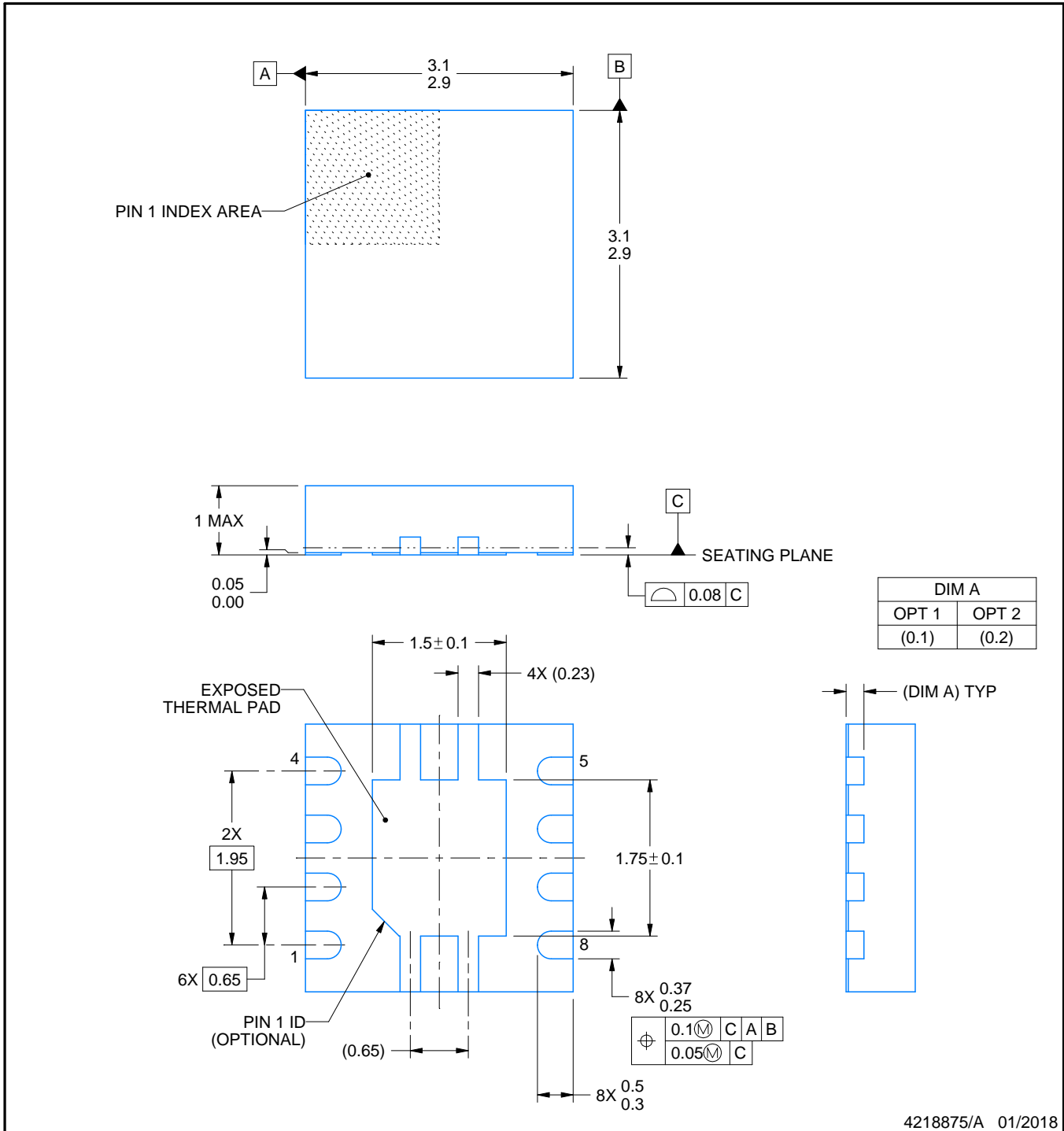

4218875/A 01/2018

NOTES:

1. All linear dimensions are in millimeters. Any dimensions in parenthesis are for reference only. Dimensioning and tolerancing per ASME Y14.5M.
2. This drawing is subject to change without notice.
3. The package thermal pad must be soldered to the printed circuit board for thermal and mechanical performance.

EXAMPLE BOARD LAYOUT

DRB0008A

VSON - 1 mm max height

PLASTIC SMALL OUTLINE - NO LEAD



LAND PATTERN EXAMPLE
EXPOSED METAL SHOWN
SCALE:20X

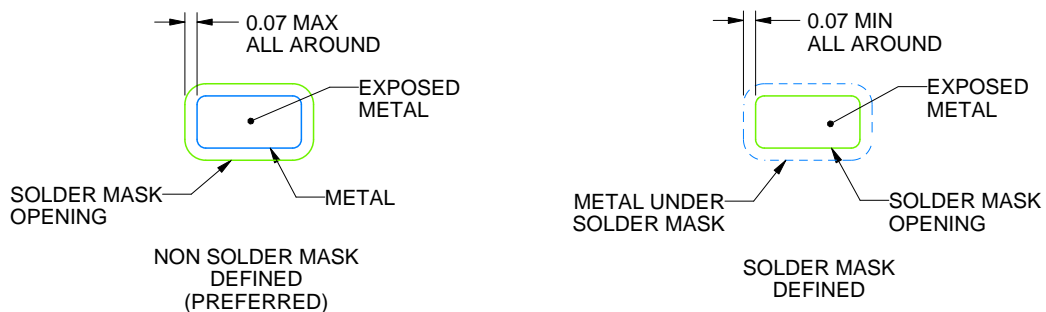

SOLDER MASK DETAILS

4218875/A 01/2018

NOTES: (continued)

4. This package is designed to be soldered to a thermal pad on the board. For more information, see Texas Instruments literature number SLUA271 (www.ti.com/lit/slua271).
5. Vias are optional depending on application, refer to device data sheet. If any vias are implemented, refer to their locations shown on this view. It is recommended that vias under paste be filled, plugged or tented.

EXAMPLE STENCIL DESIGN

DRB0008A

VSON - 1 mm max height

PLASTIC SMALL OUTLINE - NO LEAD



SOLDER PASTE EXAMPLE
BASED ON 0.125 mm THICK STENCIL

EXPOSED PAD
84% PRINTED SOLDER COVERAGE BY AREA
SCALE:25X

4218875/A 01/2018

NOTES: (continued)

6. Laser cutting apertures with trapezoidal walls and rounded corners may offer better paste release. IPC-7525 may have alternate design recommendations.

GENERIC PACKAGE VIEW

DGN 8

PowerPAD VSSOP - 1.1 mm max height

3 x 3, 0.65 mm pitch

SMALL OUTLINE PACKAGE

This image is a representation of the package family, actual package may vary.
Refer to the product data sheet for package details.

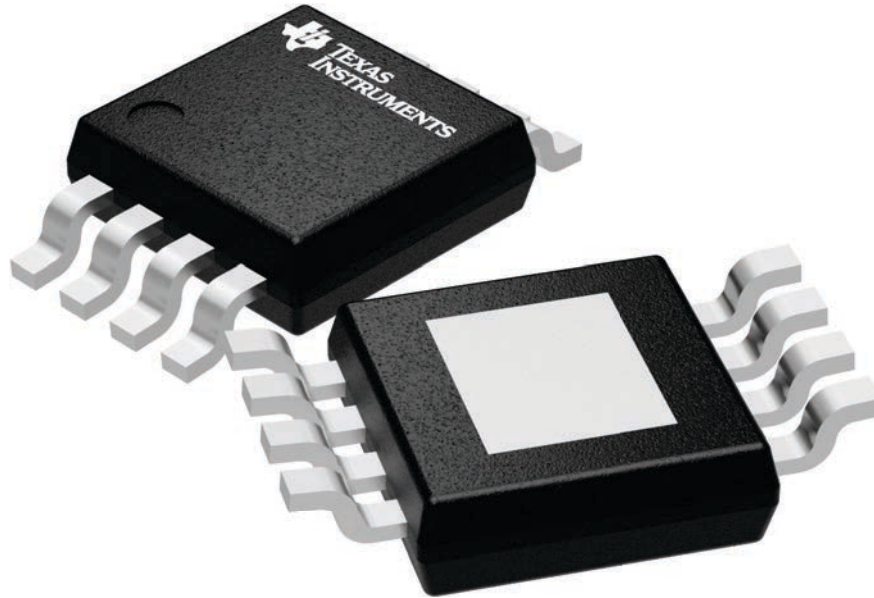

4225482/A

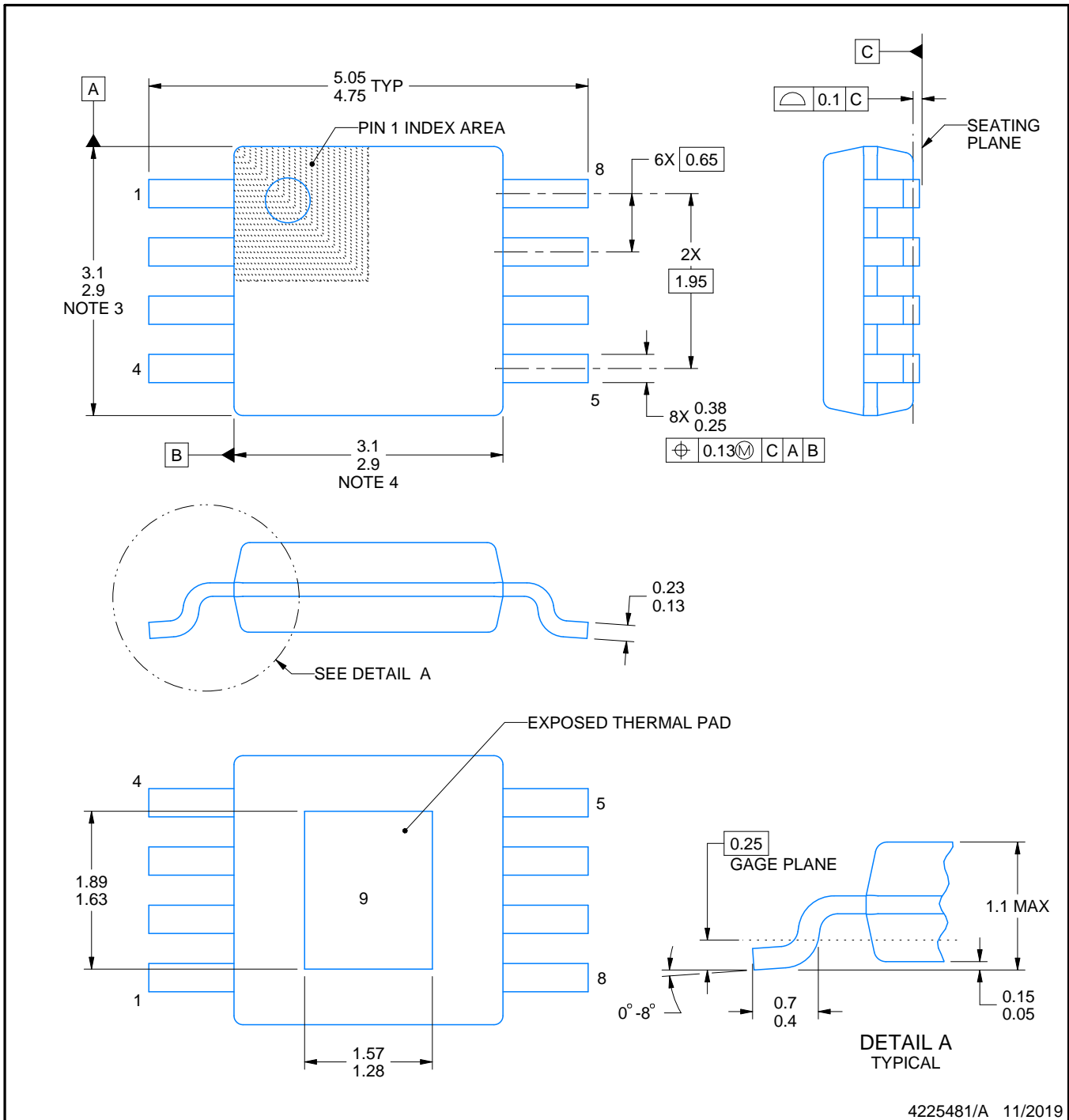
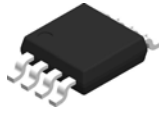

4225481/A 11/2019

NOTES:

PowerPAD is a trademark of Texas Instruments.

1. All linear dimensions are in millimeters. Any dimensions in parenthesis are for reference only. Dimensioning and tolerancing per ASME Y14.5M.
2. This drawing is subject to change without notice.
3. This dimension does not include mold flash, protrusions, or gate burrs. Mold flash, protrusions, or gate burrs shall not exceed 0.15 mm per side.
4. This dimension does not include interlead flash. Interlead flash shall not exceed 0.25 mm per side.
5. Reference JEDEC registration MO-187.

EXAMPLE BOARD LAYOUT

DGN0008D

PowerPAD™ VSSOP - 1.1 mm max height

SMALL OUTLINE PACKAGE

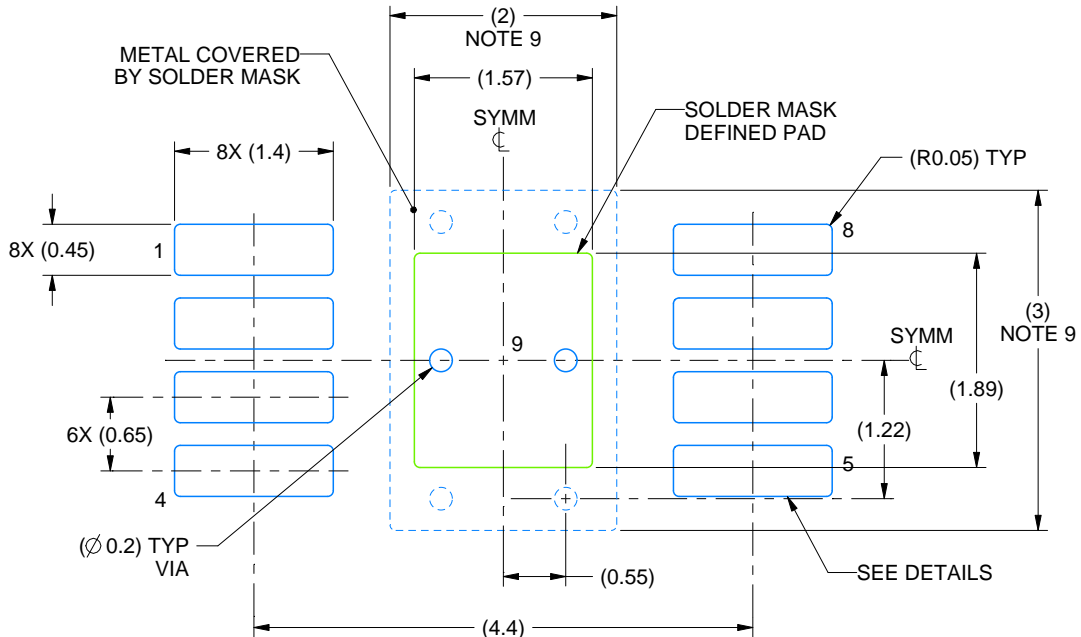

LAND PATTERN EXAMPLE
EXPOSED METAL SHOWN
SCALE: 15X

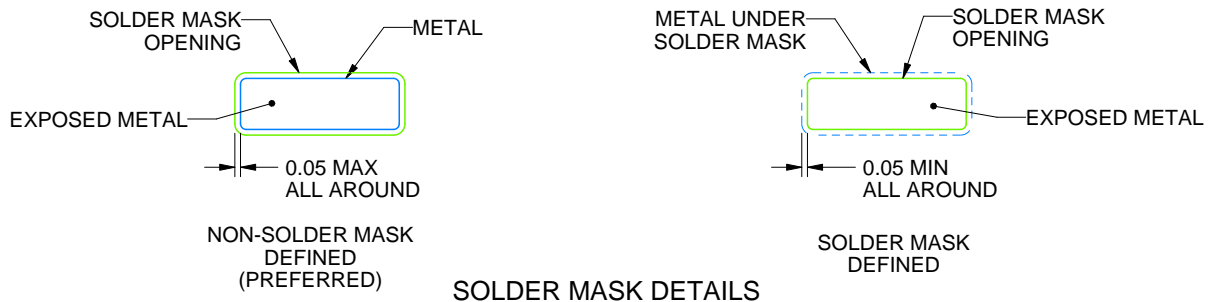

SOLDER MASK DETAILS

4225481/A 11/2019

NOTES: (continued)

6. Publication IPC-7351 may have alternate designs.
7. Solder mask tolerances between and around signal pads can vary based on board fabrication site.
8. Vias are optional depending on application, refer to device data sheet. If any vias are implemented, refer to their locations shown on this view. It is recommended that vias under paste be filled, plugged or tented.
9. Size of metal pad may vary due to creepage requirement.

EXAMPLE STENCIL DESIGN

DGN0008D

PowerPAD™ VSSOP - 1.1 mm max height

SMALL OUTLINE PACKAGE

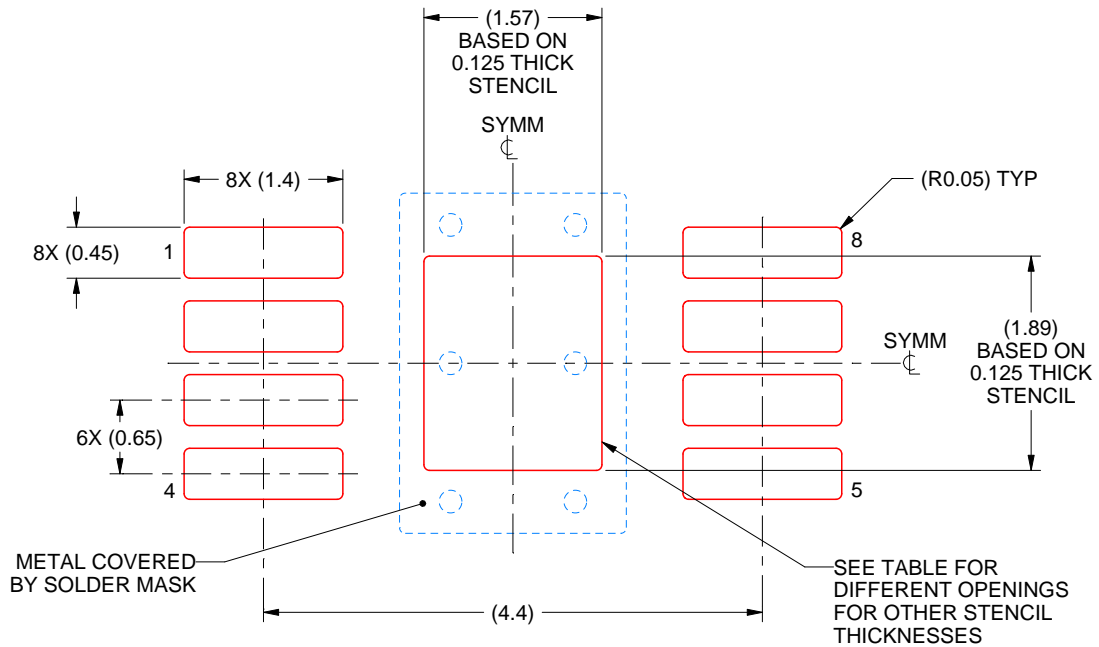

SOLDER PASTE EXAMPLE
 EXPOSED PAD 9:
 100% PRINTED SOLDER COVERAGE BY AREA
 SCALE: 15X

STENCIL THICKNESS	SOLDER STENCIL OPENING
0.1	1.76 X 2.11
0.125	1.57 X 1.89 (SHOWN)
0.15	1.43 X 1.73
0.175	1.33 X 1.60

4225481/A 11/2019

NOTES: (continued)

10. Laser cutting apertures with trapezoidal walls and rounded corners may offer better paste release. IPC-7525 may have alternate design recommendations.
11. Board assembly site may have different recommendations for stencil design.

IMPORTANT NOTICE AND DISCLAIMER

TI PROVIDES TECHNICAL AND RELIABILITY DATA (INCLUDING DATASHEETS), DESIGN RESOURCES (INCLUDING REFERENCE DESIGNS), APPLICATION OR OTHER DESIGN ADVICE, WEB TOOLS, SAFETY INFORMATION, AND OTHER RESOURCES "AS IS" AND WITH ALL FAULTS, AND DISCLAIMS ALL WARRANTIES, EXPRESS AND IMPLIED, INCLUDING WITHOUT LIMITATION ANY IMPLIED WARRANTIES OF MERCHANTABILITY, FITNESS FOR A PARTICULAR PURPOSE OR NON-INFRINGEMENT OF THIRD PARTY INTELLECTUAL PROPERTY RIGHTS.

These resources are intended for skilled developers designing with TI products. You are solely responsible for (1) selecting the appropriate TI products for your application, (2) designing, validating and testing your application, and (3) ensuring your application meets applicable standards, and any other safety, security, or other requirements. These resources are subject to change without notice. TI grants you permission to use these resources only for development of an application that uses the TI products described in the resource. Other reproduction and display of these resources is prohibited. No license is granted to any other TI intellectual property right or to any third party intellectual property right. TI disclaims responsibility for, and you will fully indemnify TI and its representatives against, any claims, damages, costs, losses, and liabilities arising out of your use of these resources.

TI's products are provided subject to TI's Terms of Sale (www.ti.com/legal/termsofsale.html) or other applicable terms available either on ti.com or provided in conjunction with such TI products. TI's provision of these resources does not expand or otherwise alter TI's applicable warranties or warranty disclaimers for TI products.

Mailing Address: Texas Instruments, Post Office Box 655303, Dallas, Texas 75265
Copyright © 2020, Texas Instruments Incorporated