

Excilibur™ LOW-NOISE HIGH-SPEED PRECISION OPERATIONAL AMPLIFIER

FEATURES

- **Controlled Baseline**
 - One Assembly Site
 - One Test Site
 - One Fabrication Site
 - **Extended Temperature Performance of –55°C to 125°C**
 - **Enhanced Diminishing Manufacturing Sources (DMS) Support**
 - **Enhanced Product-Change Notification**
 - **Qualification Pedigree⁽¹⁾**
- (1) Component qualification in accordance with JEDEC and industry standards to ensure reliable operation over an extended temperature range. This includes, but is not limited to, Highly Accelerated Stress Test (HAST) or biased 85/85, temperature cycle, autoclave or unbiased HAST, electromigration, bond intermetallic life, and mold compound life. Such qualification testing should not be viewed as justifying use of this component beyond specified performance and environmental limits.
- **Low Noise**
 - 10 Hz...15 nV/√Hz
 - 1 kHz...10.5 nV/√Hz
 - **10 000-pF Load Capability**
 - **20-mA (Min) Short-Circuit Output Current**
 - **27-V/μs Slew Rate (Min)**
 - **High Gain-Bandwidth Product...5.9 MHz**
 - **Low V_{IO} ...900 μV (Max) at 25°C**
 - **Single or Split Supply...4 V to 44 V**
 - **Fast Settling Time**
 - 340 ns to 0.1%
 - 400 ns to 0.01%
 - **Saturation Recovery...150 ns**
 - **Large Output Swing...
 $V_{CC-} + 0.1 V$ to $V_{CC+} - 1 V$**

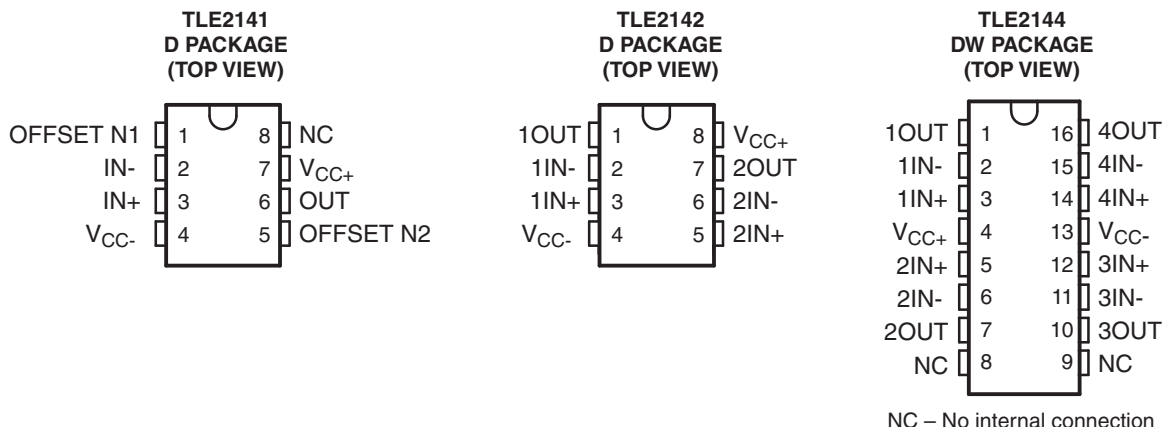

DESCRIPTION

The TLE214x devices are high-performance, internally compensated operational amplifiers built using the Texas Instruments complementary bipolar Excilibur™ process. They are pin-compatible upgrades to standard industry products.

The design incorporates an input stage that simultaneously achieves low audio-band noise of 10.5 nV/√Hz with a 10-Hz 1/f corner and symmetrical 40-V/μs slew rate typically with loads up to 800 pF. The resulting low distortion and high power bandwidth are important in high-fidelity audio applications. A fast settling time of 340 ns to 0.1% of a 10-V step with a 2-kΩ/100-pF load is useful in fast actuator/positioning drivers. Under similar test conditions, settling time to 0.01% is 400 ns.



Please be aware that an important notice concerning availability, standard warranty, and use in critical applications of Texas Instruments semiconductor products and disclaimers thereto appears at the end of this data sheet.

Excilibur is a trademark of Texas Instruments.

The devices are stable with capacitive loads up to 10 nF, although the 6-MHz bandwidth decreases to 1.8 MHz at this high loading level. As such, the TLE214x are useful for low-droop sample-and-holds and direct buffering of long cables, including 4-mA to 20-mA current loops.

The special design also exhibits an improved insensitivity to inherent integrated circuit component mismatches as is evidenced by a 900- μ V maximum offset voltage and 1.7- μ V/ $^{\circ}$ C typical drift. Minimum common-mode rejection ratio and supply-voltage rejection ratio are 85 dB and 90 dB, respectively.

Device performance is relatively independent of supply voltage over the ± 2 -V to ± 22 -V range. Inputs can operate between $V_{CC-} - 0.3$ V to $V_{CC+} - 1.8$ V without inducing phase reversal, although excessive input current may flow out of each input exceeding the lower common-mode input range. The all-npn output stage provides a nearly rail-to-rail output swing of $V_{CC-} - 0.1$ V to $V_{CC+} - 1$ V under light current-loading conditions. The device can sustain shorts to either supply since output current is internally limited, but care must be taken to ensure that maximum package power dissipation is not exceeded.

Both versions can also be used as comparators. Differential inputs of $V_{CC\pm}$ can be maintained without damage to the device. Open-loop propagation delay with TTL supply levels is typically 200 ns. This gives a good indication as to output stage saturation recovery when the device is driven beyond the limits of recommended output swing.

The TLE214x devices are available in industry-standard 8-pin and 16-pin small-outline packages. The devices are characterized for operation from -55° C to 125° C.

ORDERING INFORMATION⁽¹⁾

T_A	PACKAGE ⁽²⁾			ORDERABLE PART NUMBER	TOP-SIDE MARKING
-55° C to 125° C	Single	SOIC – D (8 pin)	Reel of 2500	TLE2141MDREP	2141EP
	Dual	SOIC – D (8 pin)	Reel of 2500	TLE2142MDREP ⁽³⁾	TBD
	Quad	SOIC – DW (16 pin)	Reel of 2000	TLE2144MDWREP ⁽³⁾	TBD

- (1) For the most current package and ordering information, see the Package Option Addendum at the end of this document, or see the TI web site at www.ti.com.
 (2) Package drawings, thermal data, and symbolization are available at www.ti.com/packaging.
 (3) Product Preview. Contact your TI sales representative for availability.

SYMBOL

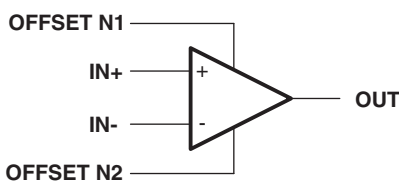

- A. OFFSET N1 and OFFSET N2 are available only on the TLE2141.

EQUIVALENT SCHEMATIC

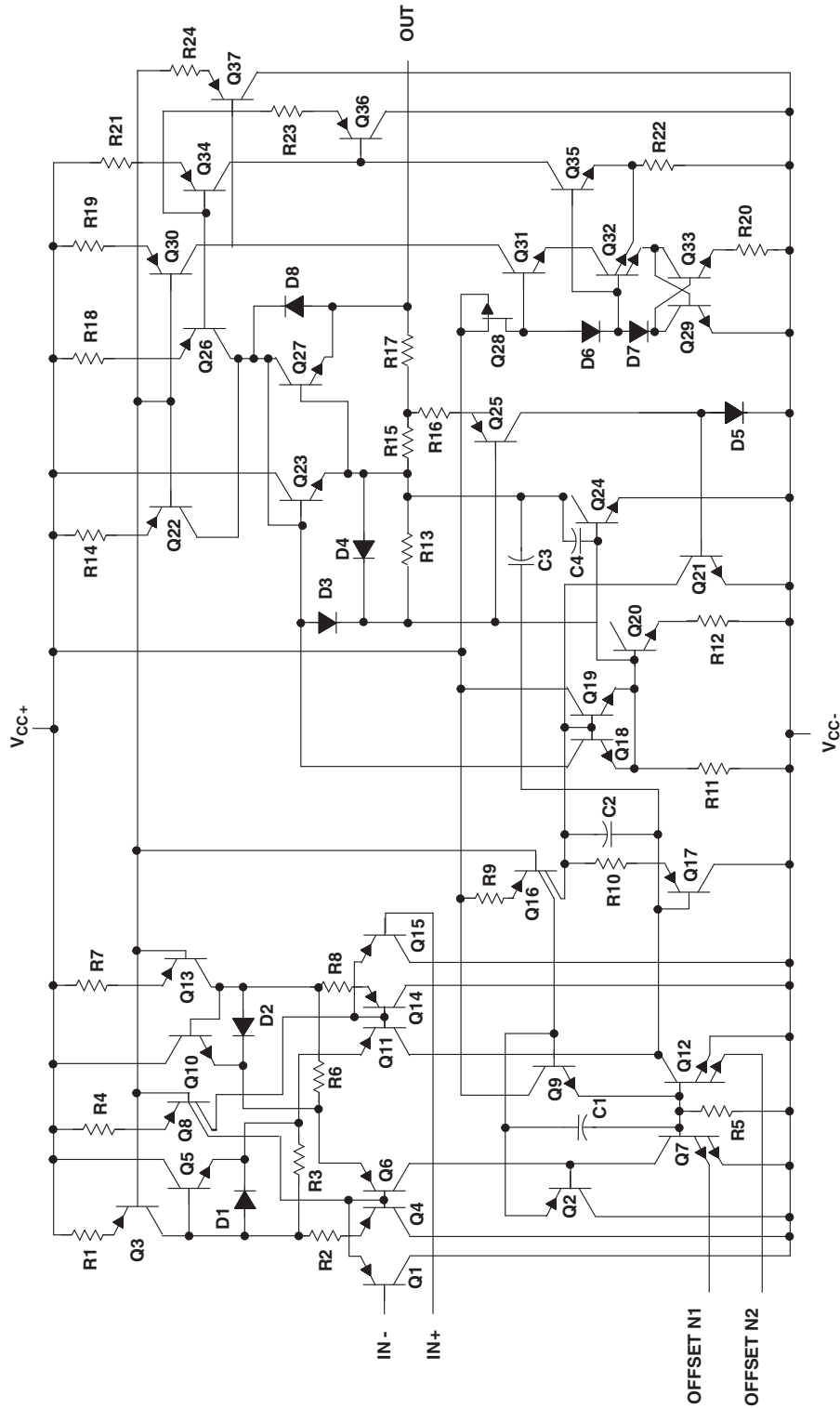

DEVICE COMPONENT COUNT

COMPONENT	TLE2141	TLE2142	TLE2144
Transistors	46	65	130
Resistors	24	43	86
Diodes	8	14	28
Capacitors	4	8	16
Epi-FET	1	1	2

A. OFFSET N1 and OFFSET N2 are available only on the TLE2141.

ABSOLUTE MAXIMUM RATINGS⁽¹⁾

over operating free-air temperature range (unless otherwise noted)

V_{CC+}	Supply voltage ⁽²⁾		22 V
V_{CC-}	Supply voltage		–22 V
V_{ID}	Differential input voltage ⁽³⁾		±44 V
V_I	Input voltage range (any input)		V_{CC+} V to $(V_{CC-} - 0.3)$ V
I_I	Input current (each input)		±1 mA
I_O	Output current		±80 mA
	Total current into V_{CC+}		80 mA
	Total current out of V_{CC-}		80 mA
	Duration of short-circuit current at (or below) 25°C ⁽⁴⁾		Unlimited
θ_{JA}	Package thermal impedance ⁽⁵⁾⁽⁶⁾	D package	97.1°C/W
		DW package	57.3°C/W
T_A	Operating free-air temperature range		–55°C to 125 °C
T_{stg}	Storage temperature range ⁽⁷⁾		–65°C to 150 °C
	Lead temperature 1,6 mm (1/16 inch) from case for 10 seconds		260°C

- (1) Stresses beyond those listed under *absolute maximum ratings* may cause permanent damage to the device. These are stress ratings only, and functional operation of the device at these or any other conditions beyond those indicated under *recommended operating conditions* is not implied. Exposure to absolute-maximum-rated conditions for extended periods may affect device reliability.
- (2) All voltage values, except differential voltages, are with respect to the midpoint between V_{CC+} and V_{CC-} .
- (3) Differential voltages are at IN+ with respect to IN–. Excessive current flows, if input, are brought below $V_{CC-} - 0.3$ V.
- (4) The output may be shorted to either supply. Temperature and/or supply voltages must be limited to ensure that the maximum dissipation rating is not exceeded.
- (5) Maximum power dissipation is a function of $T_J(\text{max})$, θ_{JA} , and T_A . The maximum allowable power dissipation at any allowable ambient temperature is $P_D = (T_J(\text{max}) - T_A)/\theta_{JA}$. Operating at the absolute maximum T_J of 150°C can affect reliability.
- (6) The package thermal impedance is calculated in accordance with JESD 51-7.
- (7) Long-term high temperature storage and/or extended use at maximum recommended operating conditions may result in a reduction of overall device life. See http://www.ti.com/ep_quality for additional information on enhanced product packaging.

RECOMMENDED OPERATING CONDITIONS

		MIN	MAX	UNIT	
$V_{CC\pm}$	Supply voltage	±2	±22	V	
V_{IC}	Common-mode input voltage	$V_{CC} = 5$ V	0	2.7	V
		$V_{CC\pm} = \pm 15$ V	–15	12.7	
T_A	Operating free-air temperature	–55	125	°C	

TLE2141 ELECTRICAL CHARACTERISTICS

 $V_{CC} = 5\text{ V}$, at specified free-air temperature (unless otherwise noted)

PARAMETER	TEST CONDITIONS	T_A ⁽¹⁾	TLE2141			UNIT
			MIN	TYP	MAX	
V_{IO} Input offset voltage	$V_O = 2.5\text{ V}$, $R_S = 50\ \Omega$, $V_{IC} = 2.5\text{ V}$	25°C		225	1400	μV
		Full range			2100	
α_{VIO} Temperature coefficient of input offset voltage	$V_O = 2.5\text{ V}$, $R_S = 50\ \Omega$, $V_{IC} = 2.5\text{ V}$	Full range		1.7		$\mu\text{V}/^\circ\text{C}$
I_{IO} Input offset current	$V_O = 2.5\text{ V}$, $R_S = 50\ \Omega$, $V_{IC} = 2.5\text{ V}$	25°C		8	100	nA
		Full range			250	
I_{IB} Input bias current	$V_O = 2.5\text{ V}$, $R_S = 50\ \Omega$, $V_{IC} = 2.5\text{ V}$	25°C		-0.8	-2	μA
		Full range			-2.3	
V_{ICR} Common-mode input voltage range	$R_S = 50\ \Omega$	25°C	0 to 3	-0.3 to 3.2		V
		Full range	0 to 2.7	-0.3 to 2.9		
V_{OH} High-level output voltage	$I_{OH} = -150\ \mu\text{A}$ $I_{OH} = -1.5\text{ mA}$ $I_{OH} = -15\text{ mA}$ $I_{OH} = -100\ \mu\text{A}$ $I_{OH} = -1\text{ mA}$ $I_{OH} = -10\text{ mA}$	25°C		3.9	4.1	V
				3.8	4	
				3.2	3.7	
		Full range		3.75		
				3.65		
				3.25		
V_{OL} Low-level output voltage	$I_{OL} = 150\ \mu\text{A}$ $I_{OL} = 1.5\text{ mA}$ $I_{OL} = 15\text{ mA}$ $I_{OL} = 100\ \mu\text{A}$ $I_{OL} = 1\text{ mA}$ $I_{OL} = 10\text{ mA}$	25°C		75	125	mV
				150	225	
				1.2	1.6	
		Full range		200		
				250		
				1.25		
A_{VD} Large-signal differential voltage amplification	$V_{IC} = 2.5\text{ V}$, $R_L = 2\text{ k}\Omega$, $V_O = 1\text{ V}$ to -1.5 V	25°C	50	220	V/mV	
		Full range	5			
r_i Input resistance		25°C		70	M Ω	
c_i Input capacitance		25°C		2.5	pF	
z_o Open-loop output impedance	$f = 1\text{ MHz}$	25°C		30	Ω	
CMRR Common-mode rejection ratio	$V_{IC} = V_{ICR}(\text{min})$, $R_S = 50\ \Omega$	25°C	85	118	dB	
		Full range	80			
k_{SVR} Supply-voltage rejection ratio ($\Delta V_{CC\pm}/\Delta V_{IO}$)	$V_{CC\pm} = \pm 2.5\text{ V}$ to $\pm 15\text{ V}$, $R_S = 50\ \Omega$	25°C	90	106	dB	
		Full range	85			
I_{CC} Supply current	$V_O = 2.5\text{ V}$, No load, $V_{IC} = 2.5\text{ V}$	25°C		3.4	4.4	mA
		Full range			4.6	

 (1) Full range is -55°C to 125°C .

TLE2141 OPERATING CHARACTERISTICS

$V_{CC} = 5\text{ V}$, $T_A = 25^\circ\text{C}$ (unless otherwise noted)

PARAMETER		TEST CONDITIONS		TLE2141			UNIT
				MIN	TYP	MAX	
SR+	Positive slew rate	$A_{VD} = -1$, $R_L = 2\text{ k}\Omega^{(1)}$, $C_L = 500\text{ pF}$			45		V/ μs
SR-	Negative slew rate	$A_{VD} = -1$, $R_L = 2\text{ k}\Omega^{(1)}$, $C_L = 500\text{ pF}$			42		V/ μs
t_s	Settling time	$A_{VD} = -1$, 2.5-V step	To 0.1%		0.16		μs
			To 0.01%		0.22		
V_n	Equivalent input noise voltage	$R_S = 20\ \Omega$	f = 10 Hz		15		nV/ $\sqrt{\text{Hz}}$
			f = 1 kHz		10.5		
$V_{N(PP)}$	Peak-to-peak equivalent input noise voltage	f = 0.1 Hz to 1 Hz			0.48		μV
		f = 0.1 Hz to 10 Hz			0.51		
I_n	Equivalent input noise current	f = 10 Hz			1.92		$\text{pA}/\sqrt{\text{Hz}}$
		f = 1 kHz			0.5		
THD+N	Total harmonic distortion plus noise	$V_O = 1\text{ V to }3\text{ V}$, $R_L = 2\text{ k}\Omega^{(1)}$, $A_{VD} = 2$, f = 10 kHz			0.0052		%
B_1	Unity-gain bandwidth	$R_L = 2\text{ k}\Omega^{(1)}$, $C_L = 100\text{ pF}^{(1)}$			5.9		MHz
	Gain-bandwidth product	$R_L = 2\text{ k}\Omega^{(1)}$, $C_L = 100\text{ pF}^{(1)}$, f = 100 kHz			5.8		MHz
B_{OM}	Maximum output-swing bandwidth	$V_{O(PP)} = 2\text{ V}$, $R_L = 2\text{ k}\Omega^{(1)}$, $A_{VD} = 1$			660		kHz
ϕ_m	Phase margin at unity gain	$R_L = 2\text{ k}\Omega^{(1)}$, $C_L = 100\text{ pF}^{(1)}$			57		$^\circ$

(1) R_L and C_L terminated to 2.5 V.

TLE2141 ELECTRICAL CHARACTERISTICS

 $V_{CC} = \pm 15\text{ V}$, at specified free-air temperature (unless otherwise noted)

PARAMETER	TEST CONDITIONS	$T_A^{(1)}$	TLE2141			UNIT
			MIN	TYP	MAX	
V_{IO} Input offset voltage	$V_{IC} = 0, R_S = 50\ \Omega$	25°C		200	900	μV
		Full range			1700	
α_{VIO} Temperature coefficient of input offset voltage	$V_{IC} = 0, R_S = 50\ \Omega$	Full range		1.7		$\mu\text{V}/^\circ\text{C}$
I_{IO} Input offset current	$V_{IC} = 0, R_S = 50\ \Omega$	25°C		7	100	nA
		Full range			250	
I_{IB} Input bias current	$V_{IC} = 0, R_S = 50\ \Omega$	25°C		-0.7	-1.5	μA
		Full range			-1.8	
V_{ICR} Common-mode input voltage range	$R_S = 50\ \Omega$	25°C	-15 to 13	-15.3 to 13.2		V
		Full range	-15 to 12.7	-15.3 to 12.9		
V_{OM+} Maximum positive peak output voltage swing	$I_O = -150\ \mu\text{A}$ $I_O = -1.5\ \text{mA}$ $I_O = -15\ \text{mA}$ $I_O = -100\ \mu\text{A}$ $I_O = -1\ \text{mA}$ $I_O = -10\ \text{mA}$	25°C		13.8	14.1	V
				13.7	14	
				13.1	13.7	
		Full range		13.7		
				13.6		
				13.1		
V_{OM-} Maximum negative peak output voltage swing	$I_O = 150\ \mu\text{A}$ $I_O = 1.5\ \text{mA}$ $I_O = 15\ \text{mA}$ $I_O = 100\ \mu\text{A}$ $I_O = 1\ \text{mA}$ $I_O = 10\ \text{mA}$	25°C		-14.7	-14.9	V
				-14.5	-14.8	
				-13.4	-13.8	
		Full range		-14.6		
				-14.5		
				-13.4		
A_{VD} Large-signal differential voltage amplification	$V_O = \pm 10\ \text{V}, R_L = 2\ \text{k}\Omega$	25°C	100	450	V/mV	
		Full range	20			
r_i Input resistance		25°C		65	$\text{M}\Omega$	
c_i Input capacitance		25°C		2.5	pF	
z_o Open-loop output impedance	$f = 1\ \text{MHz}$	25°C		30	Ω	
CMRR Common-mode rejection ratio	$V_{IC} = V_{ICR}(\text{min}), R_S = 50\ \Omega$	25°C	85	108	dB	
		Full range	80			
k_{SVR} Supply-voltage rejection ratio ($\Delta V_{CC\pm}/\Delta V_{IO}$)	$V_{CC\pm} = \pm 2.5\ \text{V to } \pm 15\ \text{V}, R_S = 50\ \Omega$	25°C	90	106	dB	
		Full range	85			
I_{OS} Short-circuit output current	$V_O = 0$	25°C	$V_{ID} = 1\ \text{V}$	-25	-50	mA
			$V_{ID} = -1\ \text{V}$	20	31	
I_{CC} Supply current	$V_O = 0, \text{ No load}, V_{IC} = 2.5\ \text{V}$	25°C		3.5	4.5	mA
		Full range			4.7	

 (1) Full range is -55°C to 125°C .

TLE2141 OPERATING CHARACTERISTICS

$V_{CC} = \pm 15\text{ V}$, $T_A = 25^\circ\text{C}$ (unless otherwise noted)

PARAMETER		TEST CONDITIONS		TLE2141			UNIT
				MIN	TYP	MAX	
SR+	Positive slew rate	$A_{VD} = -1$, $R_L = 2\text{ k}\Omega$, $C_L = 100\text{ pF}$		27	45		V/ μs
SR–	Negative slew rate	$A_{VD} = -1$, $R_L = 2\text{ k}\Omega$, $C_L = 100\text{ pF}$		27	42		V/ μs
t_s	Settling time	$A_{VD} = -1$, 10-V step	To 0.1%	0.34			μs
			To 0.01%	0.4			
V_n	Equivalent input noise voltage	$R_S = 20\ \Omega$	$f = 10\text{ Hz}$	15			$\text{nV}/\sqrt{\text{Hz}}$
			$f = 1\text{ kHz}$	10.5			
$V_{N(PP)}$	Peak-to-peak equivalent input noise voltage	$f = 0.1\text{ Hz to }1\text{ Hz}$		0.48			μV
		$f = 0.1\text{ Hz to }10\text{ Hz}$		0.51			
I_n	Equivalent input noise current	$f = 10\text{ Hz}$		1.89			$\text{pA}/\sqrt{\text{Hz}}$
		$f = 1\text{ kHz}$		0.47			
THD+N	Total harmonic distortion plus noise	$V_{O(PP)} = 20\text{ V}$, $R_L = 2\text{ k}\Omega$, $A_{VD} = 10$, $f = 10\text{ kHz}$		0.01			%
B_1	Unity-gain bandwidth	$R_L = 2\text{ k}\Omega$, $C_L = 100\text{ pF}$		6			MHz
	Gain-bandwidth product	$R_L = 2\text{ k}\Omega$, $C_L = 100\text{ pF}$, $f = 100\text{ kHz}$		5.9			MHz
B_{OM}	Maximum output-swing bandwidth	$V_{O(PP)} = 20\text{ V}$, $A_{VD} = 1$, $R_L = 2\text{ k}\Omega$, $C_L = 100\text{ pF}$		668			kHz
ϕ_m	Phase margin at unity gain	$R_L = 2\text{ k}\Omega$, $C_L = 100\text{ pF}$		58			$^\circ$

TLE2142 ELECTRICAL CHARACTERISTICS

 $V_{CC} = 5\text{ V}$, at specified free-air temperature (unless otherwise noted)

PARAMETER	TEST CONDITIONS	$T_A^{(1)}$	TLE2142			UNIT		
			MIN	TYP	MAX			
V_{IO} Input offset voltage	$V_O = 2.5\text{ V}$, $R_S = 50\ \Omega$, $V_{IC} = 2.5\text{ V}$	25°C		220	1900	μV		
		Full range			2600			
α_{VIO} Temperature coefficient of input offset voltage	$V_O = 2.5\text{ V}$, $R_S = 50\ \Omega$, $V_{IC} = 2.5\text{ V}$	Full range		1.7		$\mu\text{V}/^\circ\text{C}$		
I_{IO} Input offset current	$V_O = 2.5\text{ V}$, $R_S = 50\ \Omega$, $V_{IC} = 2.5\text{ V}$	25°C		8	100	nA		
		Full range			200			
I_{IB} Input bias current	$V_O = 2.5\text{ V}$, $R_S = 50\ \Omega$, $V_{IC} = 2.5\text{ V}$	25°C		-0.8	-2	μA		
		Full range			-2.3			
V_{ICR} Common-mode input voltage range	$R_S = 50\ \Omega$	25°C	0 to 3	-0.3 to 3.2		V		
		Full range	0 to 2.7	-0.3 to 2.9				
V_{OH} High-level output voltage	$I_{OH} = -150\ \mu\text{A}$ $I_{OH} = -1.5\text{ mA}$ $I_{OH} = -15\text{ mA}$ $I_{OH} = -100\ \mu\text{A}$ $I_{OH} = -1\text{ mA}$ $I_{OH} = -10\text{ mA}$	25°C		3.9	4.1	V		
				3.8	4			
				3.4	3.7			
		Full range		3.75				
				3.65				
				3.45				
V_{OL} Low-level output voltage	$I_{OL} = 150\ \mu\text{A}$ $I_{OL} = 1.5\text{ mA}$ $I_{OL} = 15\text{ mA}$ $I_{OL} = 100\ \mu\text{A}$ $I_{OL} = 1\text{ mA}$ $I_{OL} = 10\text{ mA}$	25°C			75	125	mV	
					150	225		
					1.2	1.4		
		Full range					200	mV
							250	
							1.25	
A_{VD} Large-signal differential voltage amplification	$V_{IC} = 2.5\text{ V}$, $R_L = 2\text{ k}\Omega$, $V_O = 1\text{ V to }1.5\text{ V}$	25°C	50	220		V/mV		
		Full range	5					
r_i Input resistance		25°C		70		M Ω		
c_i Input capacitance		25°C		2.5		pF		
z_o Open-loop output impedance	$f = 1\text{ MHz}$	25°C		30		Ω		
CMRR Common-mode rejection ratio	$V_{IC} = V_{ICR}(\text{min})$, $R_S = 50\ \Omega$	25°C	85	118		dB		
		Full range	80					
k_{SVR} Supply-voltage rejection ratio ($\Delta V_{CC\pm}/\Delta V_{IO}$)	$V_{CC\pm} = \pm 2.5\text{ V to } \pm 15\text{ V}$, $R_S = 50\ \Omega$	25°C	90	106		dB		
		Full range	85					
I_{CC} Supply current	$V_O = 2.5\text{ V}$, No load, $V_{IC} = 2.5\text{ V}$	25°C		6.6	8.8	mA		
		Full range			9.2			

 (1) Full range is -55°C to 125°C .

TLE2142 OPERATING CHARACTERISTICS

$V_{CC} = 5\text{ V}$, $T_A = 25^\circ\text{C}$ (unless otherwise noted)

PARAMETER		TEST CONDITIONS		TLE2142			UNIT
				MIN	TYP	MAX	
SR+	Positive slew rate	$A_{VD} = -1$, $R_L = 2\text{ k}\Omega^{(1)}$, $C_L = 500\text{ pF}$			45		V/ μs
SR–	Negative slew rate	$A_{VD} = -1$, $R_L = 2\text{ k}\Omega^{(1)}$, $C_L = 500\text{ pF}$			42		V/ μs
t_s	Settling time	$A_{VD} = -1$, 2.5-V step	To 0.1%		0.16		μs
			To 0.01%		0.22		
V_n	Equivalent input noise voltage	$R_S = 20\ \Omega$	$f = 10\text{ Hz}$		15		nV/ $\sqrt{\text{Hz}}$
			$f = 1\text{ kHz}$		10.5		
$V_{N(PP)}$	Peak-to-peak equivalent input noise voltage	$f = 0.1\text{ Hz to }1\text{ Hz}$			0.48		μV
		$f = 0.1\text{ Hz to }10\text{ Hz}$			0.51		
I_n	Equivalent input noise current	$f = 10\text{ Hz}$			1.92		$\text{pA}/\sqrt{\text{Hz}}$
		$f = 1\text{ kHz}$			0.5		
THD+N	Total harmonic distortion plus noise	$V_O = 1\text{ V to }3\text{ V}$, $R_L = 2\text{ k}\Omega^{(1)}$, $A_{VD} = 2$, $f = 10\text{ kHz}$			0.0052		%
B_1	Unity-gain bandwidth	$R_L = 2\text{ k}\Omega^{(1)}$, $C_L = 100\text{ pF}$			5.9		MHz
	Gain-bandwidth product	$R_L = 2\text{ k}\Omega^{(1)}$, $C_L = 100\text{ pF}$, $f = 100\text{ kHz}$			5.8		MHz
B_{OM}	Maximum output-swing bandwidth	$V_{O(PP)} = 2\text{ V}$, $R_L = 2\text{ k}\Omega^{(1)}$, $A_{VD} = 1$, $C_L = 100\text{ pF}$			660		kHz
ϕ_m	Phase margin at unity gain	$R_L = 2\text{ k}\Omega^{(1)}$, $C_L = 100\text{ pF}$			57		$^\circ$

(1) R_L terminated at 2.5 V.

TLE2142 ELECTRICAL CHARACTERISTICS

 $V_{CC} = \pm 15\text{ V}$, at specified free-air temperature (unless otherwise noted)

PARAMETER	TEST CONDITIONS	$T_A^{(1)}$	TLE2142			UNIT
			MIN	TYP	MAX	
V_{IO} Input offset voltage	$V_{IC} = 0, R_S = 50\ \Omega$	25°C		290	1200	μV
		Full range			2000	
α_{VIO} Temperature coefficient of input offset voltage	$V_{IC} = 0, R_S = 50\ \Omega$	Full range		1.7		$\mu\text{V}/^\circ\text{C}$
I_{IO} Input offset current	$V_{IC} = 0, R_S = 50\ \Omega$	25°C		7	100	nA
		Full range			250	
I_{IB} Input bias current	$V_{IC} = 0, R_S = 50\ \Omega$	25°C		-0.7	-1.5	μA
		Full range			-1.8	
V_{ICR} Common-mode input voltage range	$R_S = 50\ \Omega$	25°C	-15 to 13	-15.3 to 13.2		V
		Full range	-15 to 12.7	-15.3 to 12.9		
V_{OM+} Maximum positive peak output voltage swing	$I_O = -150\ \mu\text{A}$	25°C		13.8	14.1	V
	$I_O = -1.5\ \text{mA}$			13.7	14	
	$I_O = -15\ \text{mA}$			13.3	13.7	
	Full range	$I_O = -100\ \mu\text{A}$		13.7		
		$I_O = -1\ \text{mA}$		13.6		
		$I_O = -10\ \text{mA}$		13.3		
V_{OM-} Maximum negative peak output voltage swing	$I_O = 150\ \mu\text{A}$	25°C		-14.7	-14.9	V
	$I_O = 1.5\ \text{mA}$			-14.5	-14.8	
	$I_O = 15\ \text{mA}$			-13.4	-13.8	
	Full range	$I_O = 100\ \mu\text{A}$		-14.6		
		$I_O = 1\ \text{mA}$		-14.5		
		$I_O = 10\ \text{mA}$		-13.4		
A_{VD} Large-signal differential voltage amplification	$V_O = \pm 10\ \text{V}, R_L = 2\ \text{k}\Omega$	25°C		100	450	V/mV
		Full range		20		
r_i Input resistance		25°C		65		M Ω
c_i Input capacitance		25°C		2.5		pF
z_o Open-loop output impedance	$f = 1\ \text{MHz}$	25°C		30		Ω
CMRR Common-mode rejection ratio	$V_{IC} = V_{ICR}(\text{min}), R_S = 50\ \Omega$	25°C		85	108	dB
		Full range		80		
k_{SVR} Supply-voltage rejection ratio ($\Delta V_{CC\pm}/\Delta V_{IO}$)	$V_{CC\pm} = \pm 2.5\ \text{V to } \pm 15\ \text{V}, R_S = 50\ \Omega$	25°C		90	106	dB
		Full range		85		
I_{OS} Short-circuit output current	$V_O = 0$	25°C	$V_{ID} = 1\ \text{V}$	-25	-50	mA
			$V_{ID} = -1\ \text{V}$	20	31	
I_{CC} Supply current	$V_O = 0, \text{ No load}, V_{IC} = 2.5\ \text{V}$	25°C		6.9	9	mA
		Full range			9.4	

 (1) Full range is -55°C to 125°C .

TLE2142 OPERATING CHARACTERISTICS

$V_{CC} = \pm 15\text{ V}$, $T_A = 25^\circ\text{C}$ (unless otherwise noted)

PARAMETER		TEST CONDITIONS		TLE2142			UNIT
				MIN	TYP	MAX	
SR+	Positive slew rate	$A_{VD} = -1$, $R_L = 2\text{ k}\Omega$, $C_L = 100\text{ pF}$		27	45		V/ μs
SR-	Negative slew rate	$A_{VD} = -1$, $R_L = 2\text{ k}\Omega$, $C_L = 100\text{ pF}$		27	42		V/ μs
t_s	Settling time	$A_{VD} = -1$, 10-V step	To 0.1%	0.34			μs
			To 0.01%	0.4			
V_n	Equivalent input noise voltage	$R_S = 20\ \Omega$	$f = 10\text{ Hz}$	15			$\text{nV}/\sqrt{\text{Hz}}$
			$f = 1\text{ kHz}$	10.5			
$V_{n(PP)}$	Peak-to-peak equivalent input noise voltage	$f = 0.1\text{ Hz to }1\text{ Hz}$		0.48			μV
		$f = 0.1\text{ Hz to }10\text{ Hz}$		0.51			
I_n	Equivalent input noise current	$f = 10\text{ Hz}$		1.89			$\text{pA}/\sqrt{\text{Hz}}$
		$f = 1\text{ kHz}$		0.47			
THD+N	Total harmonic distortion plus noise	$V_{O(PP)} = 20\text{ V}$, $R_L = 2\text{ k}\Omega$, $A_{VD} = 10$, $f = 10\text{ kHz}$		0.01			%
B_1	Unity-gain bandwidth	$R_L = 2\text{ k}\Omega$, $C_L = 100\text{ pF}$		6			MHz
	Gain-bandwidth product	$R_L = 2\text{ k}\Omega$, $C_L = 100\text{ pF}$, $f = 100\text{ kHz}$		5.9			MHz
B_{OM}	Maximum output-swing bandwidth	$V_{O(PP)} = 20\text{ V}$, $A_{VD} = 1$, $R_L = 2\text{ k}\Omega$, $A_{VD} = 1$, $C_L = 100\text{ pF}$		668			kHz
ϕ_m	Phase margin at unity gain	$R_L = 2\text{ k}\Omega$, $C_L = 100\text{ pF}$		58			$^\circ$

TLE2144 ELECTRICAL CHARACTERISTICS

 $V_{CC} = 5\text{ V}$, at specified free-air temperature (unless otherwise noted)

PARAMETER	TEST CONDITIONS	T_A ⁽¹⁾	TLE2144			UNIT		
			MIN	TYP	MAX			
V_{IO} Input offset voltage	$V_O = 2.5\text{ V}$, $R_S = 50\ \Omega$, $V_{IC} = 2.5\text{ V}$	25°C		0.5	3.8	mV		
		Full range			5.2			
α_{VIO} Temperature coefficient of input offset voltage	$V_O = 2.5\text{ V}$, $R_S = 50\ \Omega$, $V_{IC} = 2.5\text{ V}$	Full range		1.7		$\mu\text{V}/^\circ\text{C}$		
I_{IO} Input offset current	$V_O = 2.5\text{ V}$, $R_S = 50\ \Omega$, $V_{IC} = 2.5\text{ V}$	25°C		8	100	nA		
		Full range			250			
I_{IB} Input bias current	$V_O = 2.5\text{ V}$, $R_S = 50\ \Omega$, $V_{IC} = 2.5\text{ V}$	25°C		-0.8	-2	μA		
		Full range			-2.3			
V_{ICR} Common-mode input voltage range	$R_S = 50\ \Omega$	25°C	0 to 3	-0.3 to 3.2		V		
		Full range	0 to 2.7	-0.3 to 2.9				
V_{OH} High-level output voltage	$I_{OH} = -150\ \mu\text{A}$ $I_{OH} = -1.5\text{ mA}$ $I_{OH} = -15\text{ mA}$ $I_{OH} = -100\ \mu\text{A}$ $I_{OH} = -1\text{ mA}$ $I_{OH} = -10\text{ mA}$	25°C		3.9	4.1	V		
				3.8	4			
				3.4	3.7			
		Full range		3.75				
				3.65				
				3.45				
V_{OL} Low-level output voltage	$I_{OL} = 150\ \mu\text{A}$ $I_{OL} = 1.5\text{ mA}$ $I_{OL} = 15\text{ mA}$ $I_{OL} = 100\ \mu\text{A}$ $I_{OL} = 1\text{ mA}$ $I_{OL} = 10\text{ mA}$	25°C			75	125	mV	
					150	225	V	
					1.2	1.6	V	
		Full range				200		mV
						250		mV
						1.45		V
A_{VD} Large-signal differential voltage amplification	$V_{IC} = 2.5\text{ V}$, $R_L = 2\text{ k}\Omega$, $V_O = 1\text{ V}$ to -1.5 V	25°C	50	95		V/mV		
		Full range	5					
r_i Input resistance		25°C		70		M Ω		
c_i Input capacitance		25°C		2.5		pF		
z_o Open-loop output impedance	$f = 1\text{ MHz}$	25°C		3.		Ω		
CMRR Common-mode rejection ratio	$V_{IC} = V_{ICR}(\text{min})$, $R_S = 50\ \Omega$	25°C	85	118		dB		
		Full range	80					
k_{SVR} Supply-voltage rejection ratio ($\Delta V_{CC\pm}/\Delta V_{IO}$)	$V_{CC\pm} = \pm 2.5\text{ V}$ to $\pm 15\text{ V}$, $R_S = 50\ \Omega$	25°C	90	106		dB		
		Full range	85					
I_{CC} Supply current	$V_O = 2.5\text{ V}$, No load, $V_{IC} = 2.5\text{ V}$	25°C		13.2	17.6	mA		
		Full range			18.4			

 (1) Full range is -55°C to 125°C .

TLE2144 OPERATING CHARACTERISTICS

$V_{CC} = 5\text{ V}$, $T_A = 25^\circ\text{C}$ (unless otherwise noted)

PARAMETER		TEST CONDITIONS		TLE2144			UNIT
				MIN	TYP	MAX	
SR+	Positive slew rate	$A_{VD} = -1$, $R_L = 2\text{ k}\Omega^{(1)}$, $C_L = 500\text{ pF}$			45		V/ μs
SR–	Negative slew rate	$A_{VD} = -1$, $R_L = 2\text{ k}\Omega^{(1)}$, $C_L = 500\text{ pF}$			42		V/ μs
t_s	Settling time	$A_{VD} = -1$, 2.5-V step	To 0.1%		0.16		μs
			To 0.01%		0.22		
V_n	Equivalent input noise voltage	$R_S = 20\ \Omega$	$f = 10\text{ Hz}$		15		nV/ $\sqrt{\text{Hz}}$
			$f = 1\text{ kHz}$		10.5		
$V_{N(PP)}$	Peak-to-peak equivalent input noise voltage	$f = 0.1\text{ Hz to }1\text{ Hz}$			0.48		μV
		$f = 0.1\text{ Hz to }10\text{ Hz}$			0.51		
I_n	Equivalent input noise current	$f = 10\text{ Hz}$			1.92		$\text{pA}/\sqrt{\text{Hz}}$
		$f = 1\text{ kHz}$			0.5		
THD+N	Total harmonic distortion plus noise	$V_O = 1\text{ V to }3\text{ V}$, $R_L = 2\text{ k}\Omega^{(1)}$, $A_{VD} = 2$, $f = 10\text{ kHz}$			0.0052		%
B_1	Unity-gain bandwidth	$R_L = 2\text{ k}\Omega^{(1)}$, $C_L = 100\text{ pF}$			5.9		MHz
	Gain-bandwidth product	$R_L = 2\text{ k}\Omega^{(1)}$, $C_L = 100\text{ pF}$, $f = 100\text{ kHz}$			5.8		MHz
B_{OM}	Maximum output-swing bandwidth	$V_{O(PP)} = 2\text{ V}$, $R_L = 2\text{ k}\Omega^{(1)}$, $A_{VD} = 1$			660		kHz
ϕ_m	Phase margin at unity gain	$R_L = 2\text{ k}\Omega^{(1)}$, $C_L = 100\text{ pF}$			57		$^\circ$

(1) R_L terminated at 2.5 V.

TLE2144 ELECTRICAL CHARACTERISTICS

 $V_{CC} = \pm 15\text{ V}$, at specified free-air temperature (unless otherwise noted)

PARAMETER	TEST CONDITIONS	T_A ⁽¹⁾	TLE2144			UNIT
			MIN	TYP	MAX	
V_{IO} Input offset voltage	$V_{IC} = 0, R_S = 50\ \Omega$	25°C		0.6	2.4	mV
		Full range			4	
α_{VIO} Temperature coefficient of input offset voltage	$V_{IC} = 0, R_S = 50\ \Omega$	25°C		1.7		$\mu\text{V}/^\circ\text{C}$
I_{IO} Input offset current	$V_{IC} = 0, R_S = 50\ \Omega$	25°C		7	100	nA
		Full range			250	
I_{IB} Input bias current	$V_{IC} = 0, R_S = 50\ \Omega$	25°C		-0.7	-1.5	μA
		Full range			-1.8	
V_{ICR} Common-mode input voltage range	$R_S = 50\ \Omega$	25°C	-15 to 13	-15.3 to 13.2		V
		Full range	-15 to 12.7	-15.3 to 12.9		
V_{OM+} Maximum positive peak output voltage swing	$I_O = -150\ \mu\text{A}$ $I_O = -1.5\ \text{mA}$ $I_O = -15\ \text{mA}$ $I_O = -100\ \mu\text{A}$ $I_O = -1\ \text{mA}$ $I_O = -10\ \text{mA}$	25°C		13.8	14.1	V
				13.7	14	
				13.1	13.7	
		Full range		13.7		
				13.6		
				13.1		
V_{OM-} Maximum negative peak output voltage swing	$I_O = 150\ \mu\text{A}$ $I_O = 1.5\ \text{mA}$ $I_O = 15\ \text{mA}$ $I_O = 100\ \mu\text{A}$ $I_O = 1\ \text{mA}$ $I_O = 10\ \text{mA}$	25°C		-14.7	-14.9	V
				-14.5	-14.8	
				-13.4	-13.8	
		Full range		-14.6		
				-14.5		
				-13.4		
A_{VD} Large-signal differential voltage amplification	$V_O = \pm 10\ \text{V}, R_L = 2\ \text{k}\Omega$	25°C	100	170	V/mV	
		Full range	20			
r_i Input resistance		25°C		65	$\text{M}\Omega$	
c_i Input capacitance		25°C		2.5	pF	
z_o Open-loop output impedance	$f = 1\ \text{MHz}$	25°C		30	Ω	
CMRR Common-mode rejection ratio	$V_{IC} = V_{ICR}(\text{min}), R_S = 50\ \Omega$	25°C	85	108	dB	
		Full range	80			
k_{SVR} Supply-voltage rejection ratio ($\Delta V_{CC\pm}/\Delta V_{IO}$)	$V_{CC\pm} = \pm 2.5\ \text{V to } \pm 15\ \text{V}, R_S = 50\ \Omega$	25°C	90	106	dB	
		Full range	85			
I_{OS} Short-circuit output current	$V_O = 0$	25°C	$V_{ID} = 1\ \text{V}$	-25	-50	mA
			$V_{ID} = -1\ \text{V}$	20	31	
I_{CC} Supply current	$V_O = 0, \text{No load}, V_{IC} = 2.5\ \text{V}$	25°C		13.8	18	mA
		Full range			18.8	

 (1) Full range is -55°C to 125°C .

TLE2144 OPERATING CHARACTERISTICS

$V_{CC} = \pm 15\text{ V}$, $T_A = 25^\circ\text{C}$ (unless otherwise noted)

PARAMETER		TEST CONDITIONS		TLE2144			UNIT
				MIN	TYP	MAX	
SR+	Positive slew rate	$A_{VD} = -1$, $R_L = 2\text{ k}\Omega$, $C_L = 100\text{ pF}$		27	45		V/ μs
SR-	Negative slew rate	$A_{VD} = -1$, $R_L = 2\text{ k}\Omega$, $C_L = 100\text{ pF}$		27	42		V/ μs
t_s	Settling time	$A_{VD} = -1$, 10-V step	To 0.1%	0.34			μs
			To 0.01%	0.4			
V_n	Equivalent input noise voltage	$R_S = 20\ \Omega$	f = 10 Hz	15			nV/ $\sqrt{\text{Hz}}$
			f = 1 kHz	10.5			
$V_{n(PP)}$	Peak-to-peak equivalent input noise voltage	f = 0.1 Hz to 1 Hz		0.48			μV
		f = 0.1 Hz to 10 Hz		0.51			
I_n	Equivalent input noise current	f = 10 Hz		1.89			pA/ $\sqrt{\text{Hz}}$
		f = 10 kHz		0.47			
THD+N	Total harmonic distortion plus noise	$V_{O(PP)} = 20\text{ V}$, $R_L = 2\text{ k}\Omega$, $A_{VD} = 10$, f = 10 kHz		0.01			%
B_1	Unity-gain bandwidth	$R_L = 2\text{ k}\Omega$, $C_L = 100\text{ pF}$		6			MHz
	Gain-bandwidth product	$R_L = 2\text{ k}\Omega$, $C_L = 100\text{ pF}$, f = 100 kHz		5.9			MHz
B_{OM}	Maximum output-swing bandwidth	$V_{O(PP)} = 20\text{ V}$, $A_{VD} = 1$, $R_L = 2\text{ k}\Omega$, $C_L = 100\text{ pF}$		668			kHz
ϕ_m	Phase margin at unity gain	$R_L = 2\text{ k}\Omega$, $C_L = 100\text{ pF}$		58			$^\circ$

TYPICAL CHARACTERISTICS

Table of Graphs

V_{IO}	Input offset voltage	Distribution	Figure 1, Figure 2, Figure 3
I_{IO}	Input offset current	vs Free-air temperature	Figure 4
I_{IB}	Input bias current	vs Common-mode input voltage	Figure 5
		vs Free-air temperature	Figure 6
V_{OM+}	Maximum positive peak output voltage	vs Supply voltage	Figure 7
		vs Free-air temperature	Figure 8
		vs Output current	Figure 9
		vs Settling time	Figure 11
V_{OM-}	Maximum negative peak output voltage	vs Supply voltage	Figure 7
		vs Free-air temperature	Figure 8
		vs Output current	Figure 10
		vs Settling time	Figure 11
$V_{O(PP)}$	Maximum peak-to-peak output voltage	vs Frequency	Figure 12
V_{OH}	High-level output voltage	vs Output current	Figure 13
V_{OL}	Low-level output voltage	vs Output current	Figure 14
	Phase shift	vs Frequency	Figure 15
A_{VD}	Large-signal differential voltage amplification	vs Frequency	Figure 15
		vs Free-air temperature	Figure 16
z_o	Closed-loop output impedance	vs Frequency	Figure 17
I_{OS}	Short-circuit output current	vs Free-air temperature	Figure 18
CMRR	Common-mode rejection ratio	vs Frequency	Figure 19
		vs Free-air temperature	Figure 20
k_{SVR}	Supply-voltage rejection ratio	vs Frequency	Figure 21
		vs Free-air temperature	Figure 22
I_{CC}	Supply current	vs Supply voltage	Figure 23
		vs Free-air temperature	Figure 24
V_n	Equivalent input noise voltage	vs Frequency	Figure 25
V_n	Input noise voltage	Over a 10-second period	Figure 26
I_n	Noise current	vs Frequency	Figure 27
THD+N	Total harmonic distortion plus noise	vs Frequency	Figure 28
SR	Slew rate	vs Free-air temperature	Figure 29
		vs Load capacitance	Figure 30
Pulse response	Noninverting large signal	vs Time	Figure 31
	Inverting large signal	vs Time	Figure 32
	Small signal	vs Time	Figure 33
B_1	Unity-gain bandwidth	vs Load capacitance	Figure 34
	Gain margin	vs Load capacitance	Figure 35
ϕ_m	Phase margin	vs Load capacitance	Figure 36

**TLE2141
DISTRIBUTION OF
INPUT OFFSET VOLTAGE**

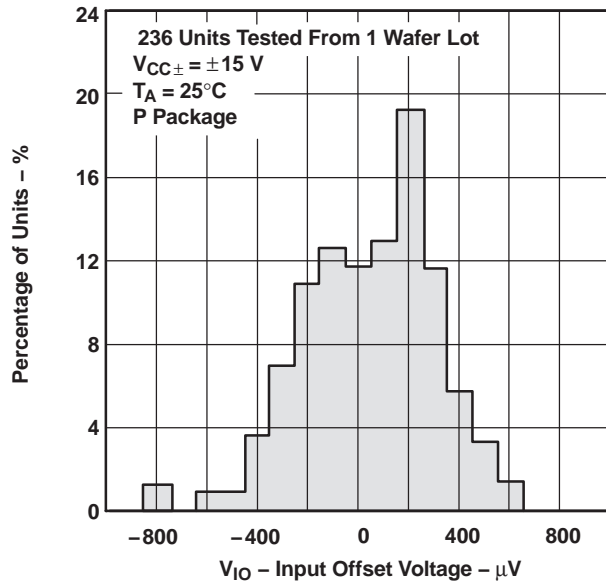

Figure 1.

**TLE2142
DISTRIBUTION OF
INPUT OFFSET VOLTAGE**

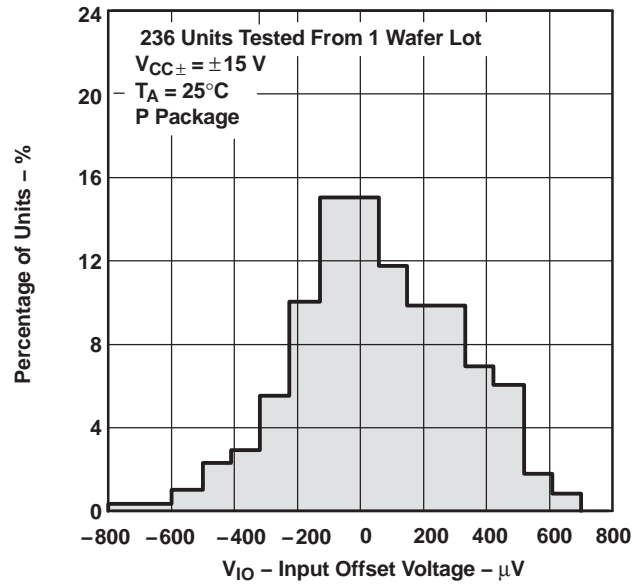

Figure 2.

**TLE2144
DISTRIBUTION OF
INPUT OFFSET VOLTAGE**

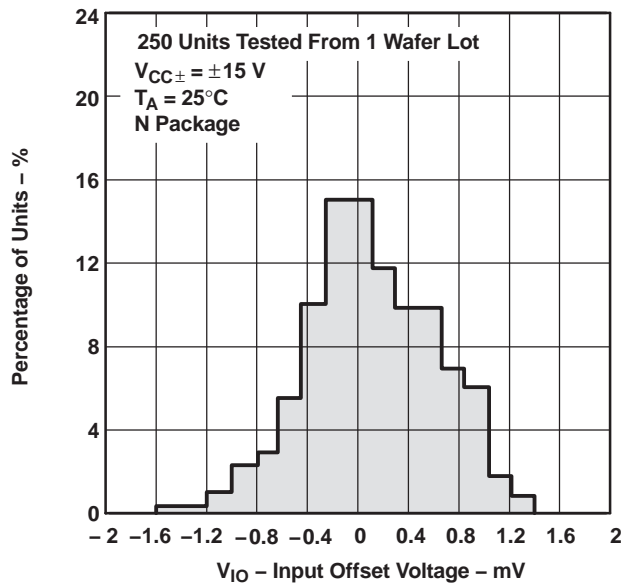

Figure 3.

**INPUT OFFSET CURRENT
vs
FREE-AIR TEMPERATURE**

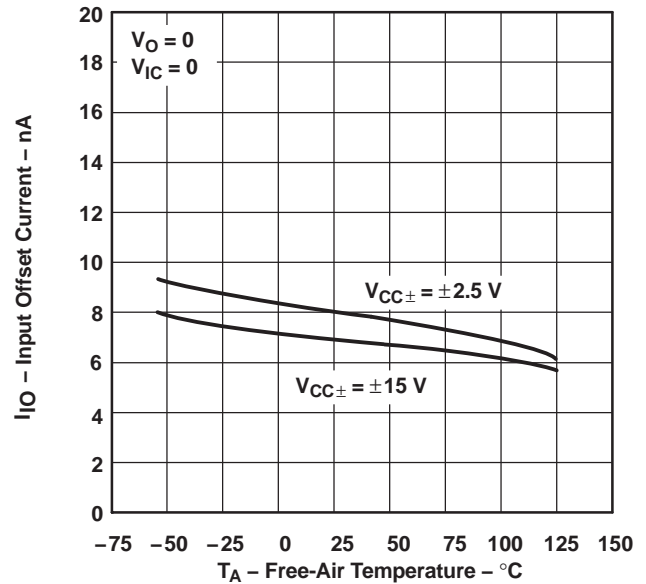

Figure 4.

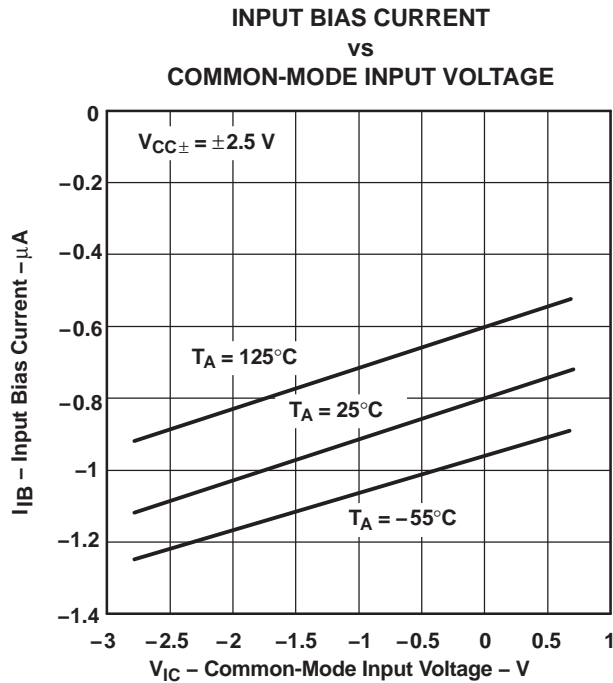

Figure 5.

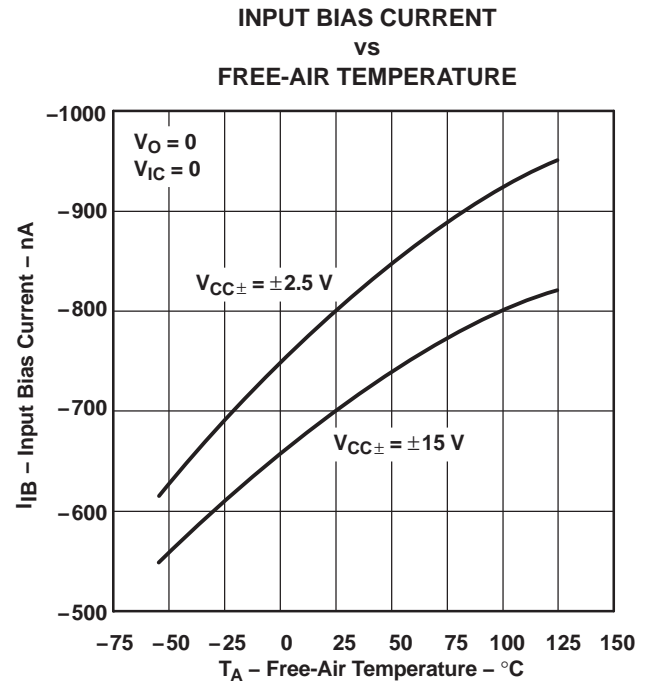

Figure 6.

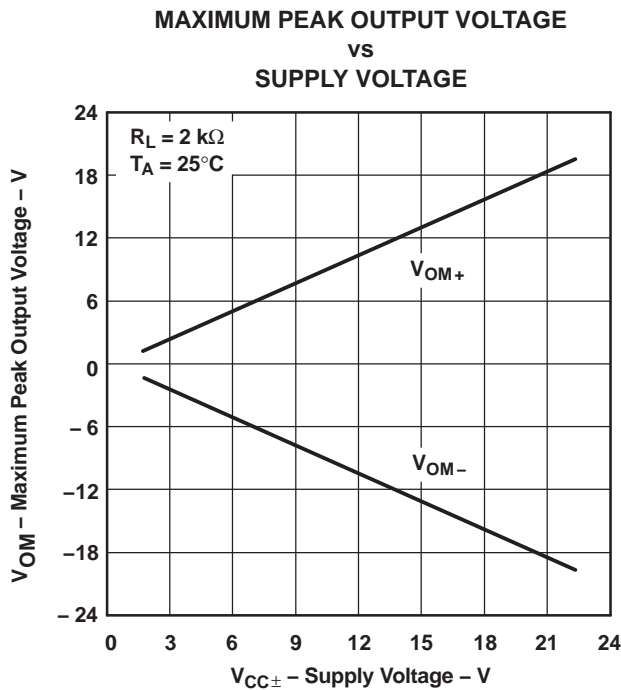

Figure 7.

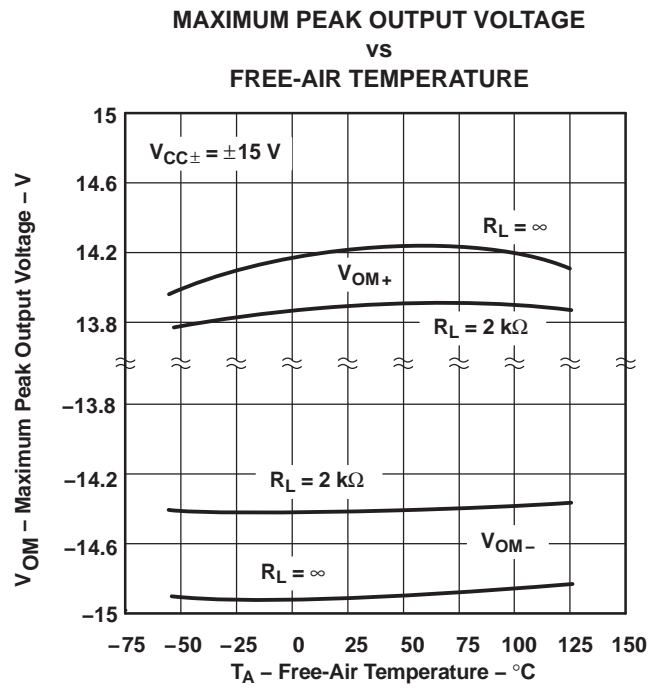

Figure 8.

**MAXIMUM POSITIVE PEAK
OUTPUT VOLTAGE
VS
OUTPUT CURRENT**

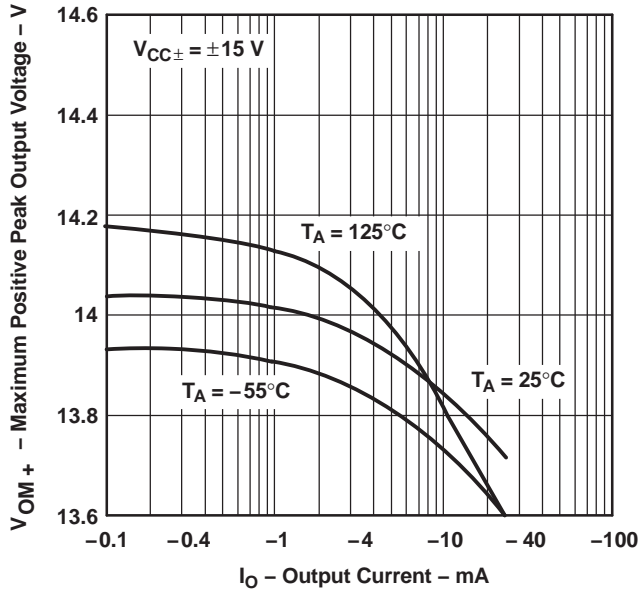

Figure 9.

**MAXIMUM NEGATIVE PEAK
OUTPUT VOLTAGE
VS
OUTPUT CURRENT**

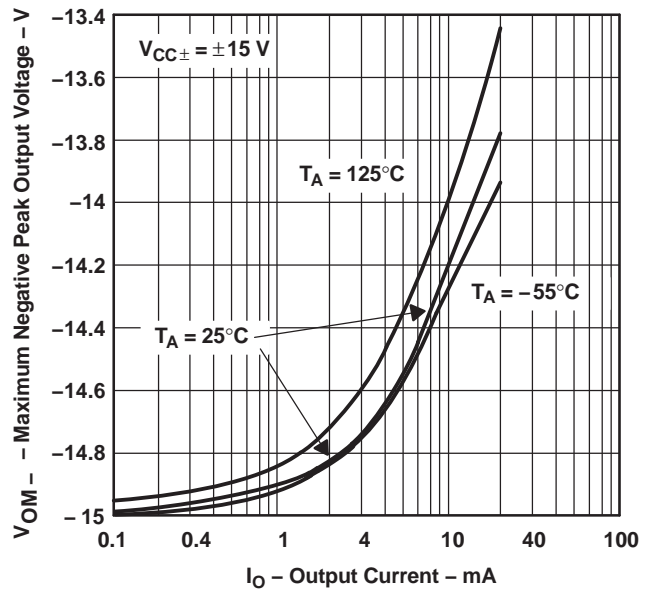

Figure 10.

**MAXIMUM PEAK OUTPUT VOLTAGE
VS
SETTLING TIME**

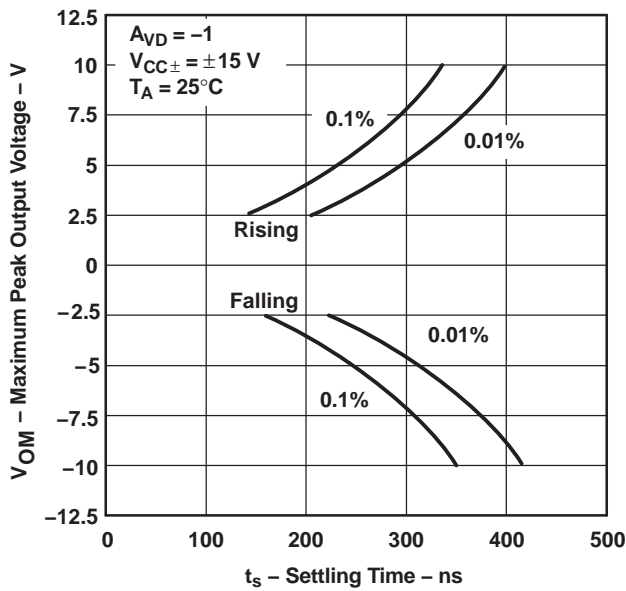

Figure 11.

**MAXIMUM PEAK-TO-PEAK
OUTPUT VOLTAGE
VS
FREQUENCY**

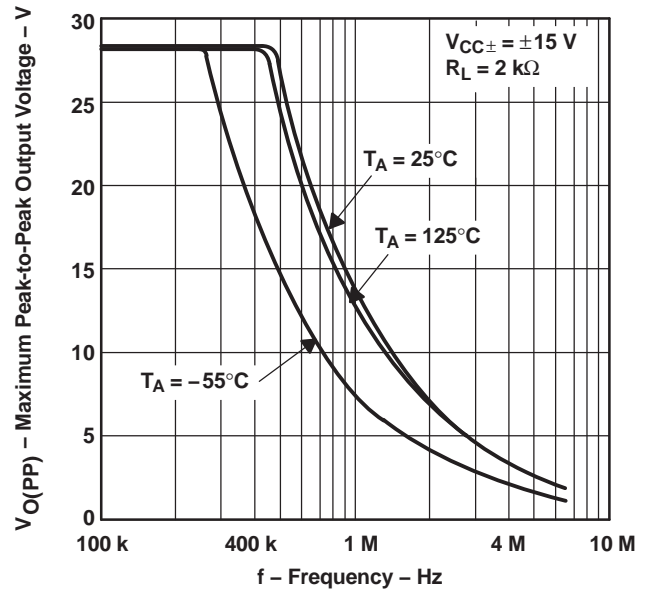

Figure 12.

HIGH-LEVEL OUTPUT VOLTAGE
VS
OUTPUT CURRENT

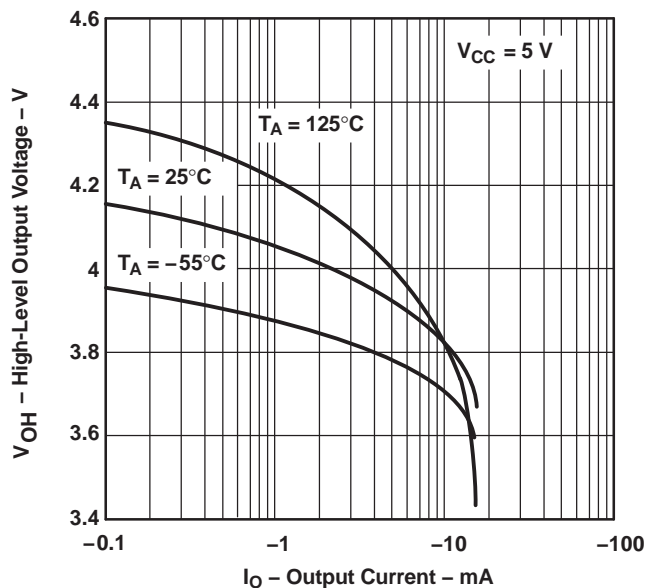

Figure 13.

LOW-LEVEL OUTPUT VOLTAGE
VS
OUTPUT CURRENT

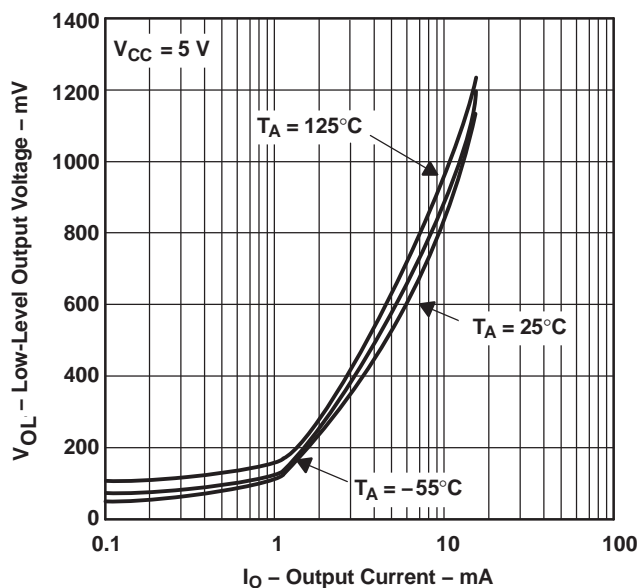

Figure 14.

LARGE-SIGNAL DIFFERENTIAL VOLTAGE
AMPLIFICATION AND PHASE SHIFT
VS
FREQUENCY

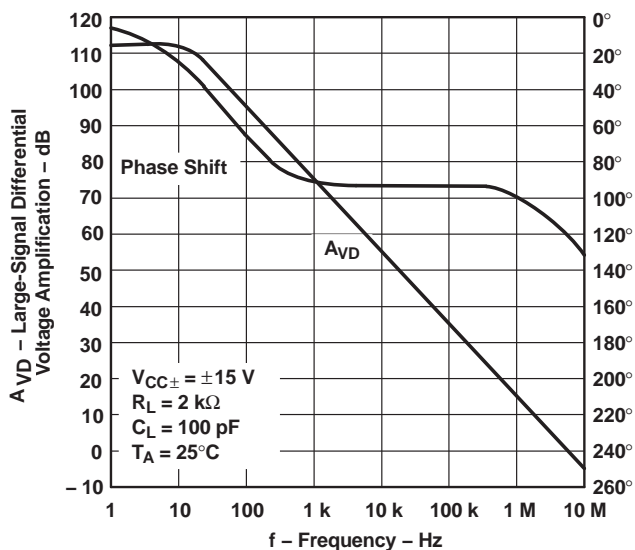

Figure 15.

LARGE-SIGNAL DIFFERENTIAL
VOLTAGE AMPLIFICATION
VS
FREE-AIR TEMPERATURE

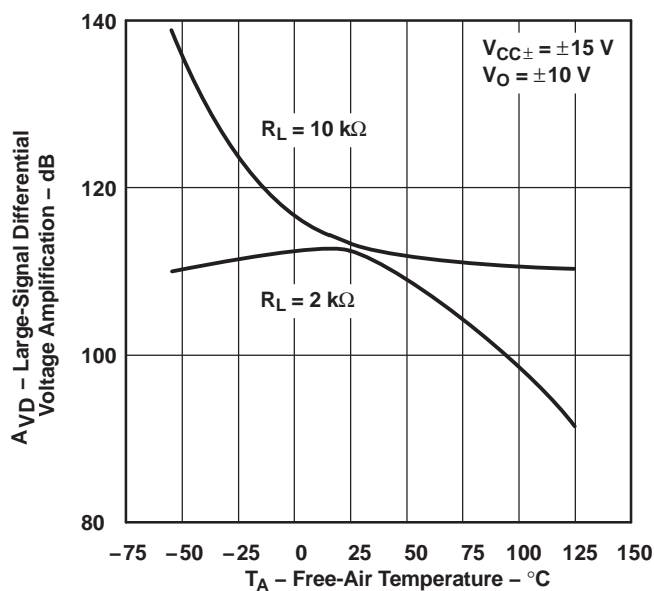

Figure 16.

CLOSED-LOOP OUTPUT IMPEDANCE
vs
FREQUENCY

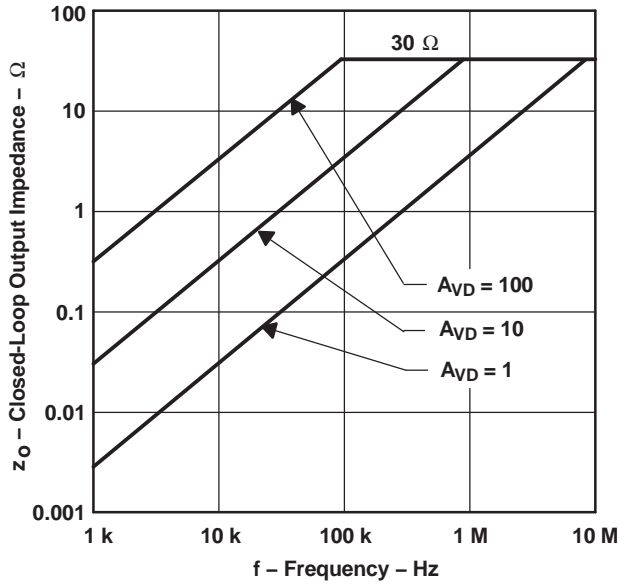

Figure 17.

SHORT-CIRCUIT OUTPUT CURRENT
vs
FREE-AIR TEMPERATURE

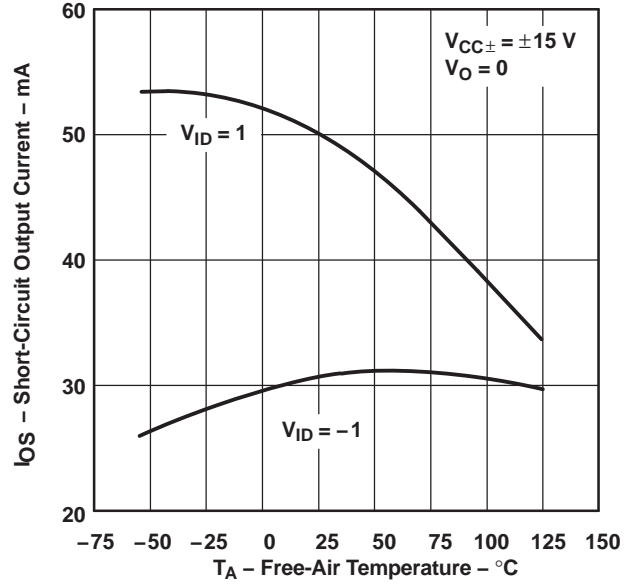

Figure 18.

COMMON-MODE REJECTION RATIO
vs
FREQUENCY

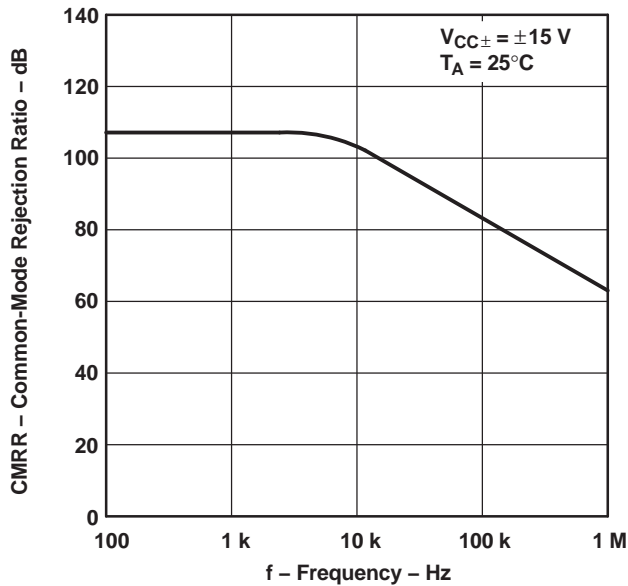

Figure 19.

COMMON-MODE REJECTION RATIO
vs
FREE-AIR TEMPERATURE

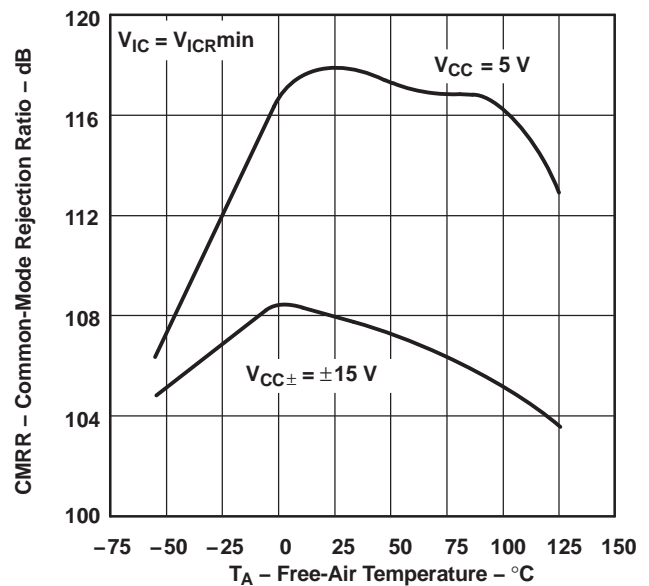

Figure 20.

SUPPLY-VOLTAGE REJECTION RATIO
VS
FREQUENCY

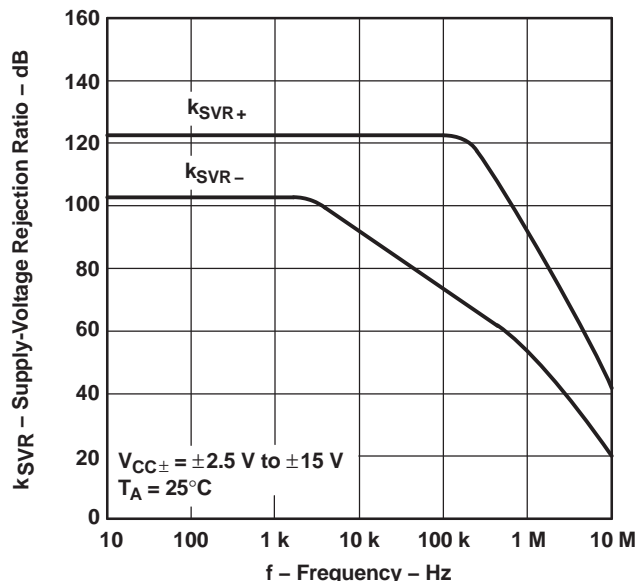

Figure 21.

SUPPLY-VOLTAGE REJECTION RATIO
VS
FREE-AIR TEMPERATURE

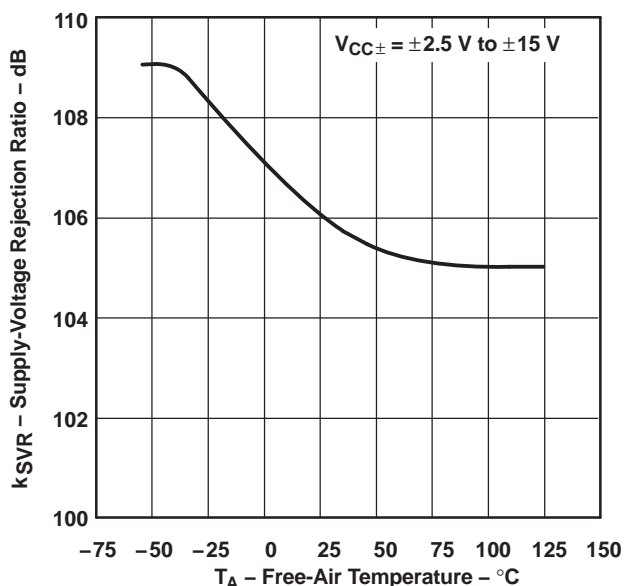

Figure 22.

SUPPLY CURRENT
VS
SUPPLY VOLTAGE

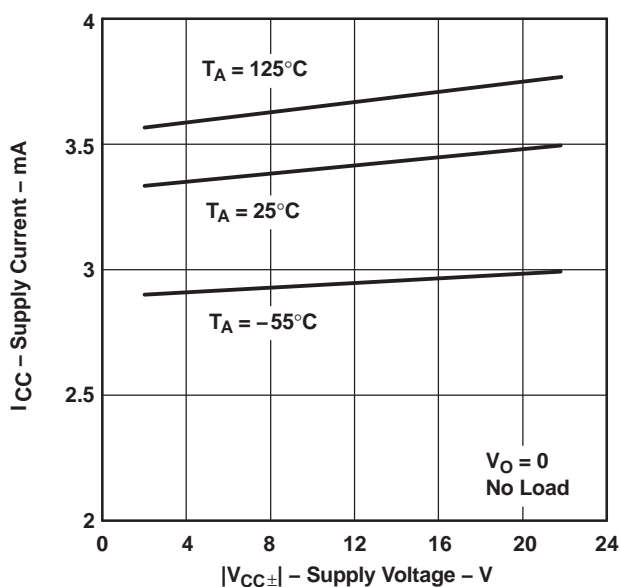

Figure 23.

SUPPLY CURRENT
VS
FREE-AIR TEMPERATURE

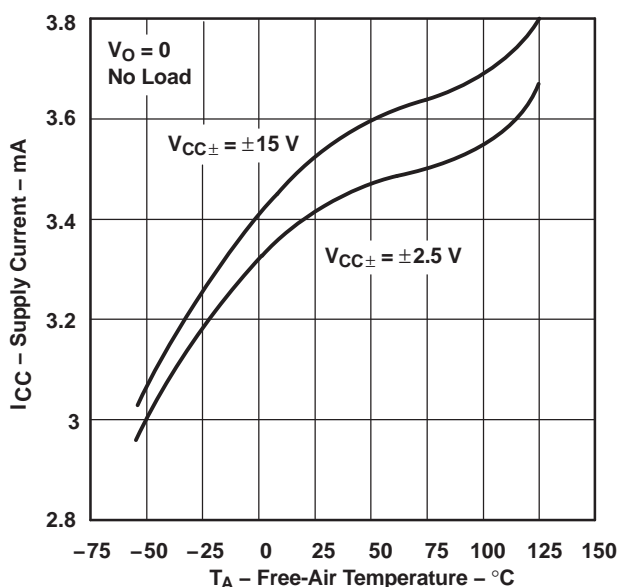

Figure 24.

EQUIVALENT INPUT NOISE VOLTAGE
vs
FREQUENCY

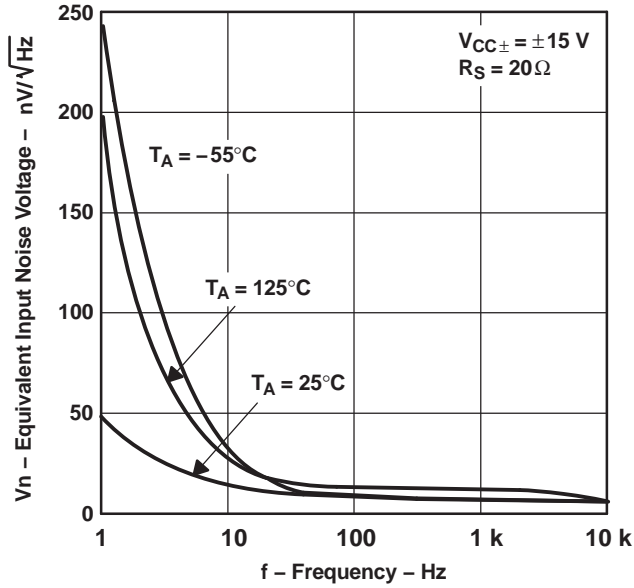

Figure 25.
NOISE CURRENT
vs
FREQUENCY

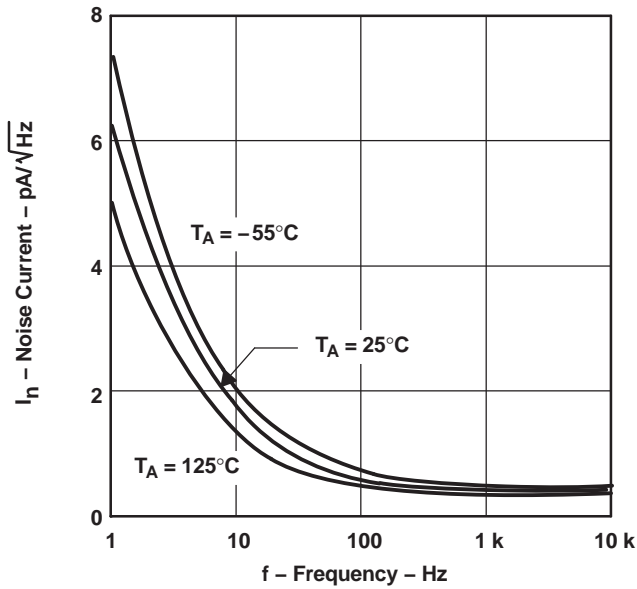

Figure 27.

INPUT NOISE VOLTAGE
OVER A 10-SECOND PERIOD

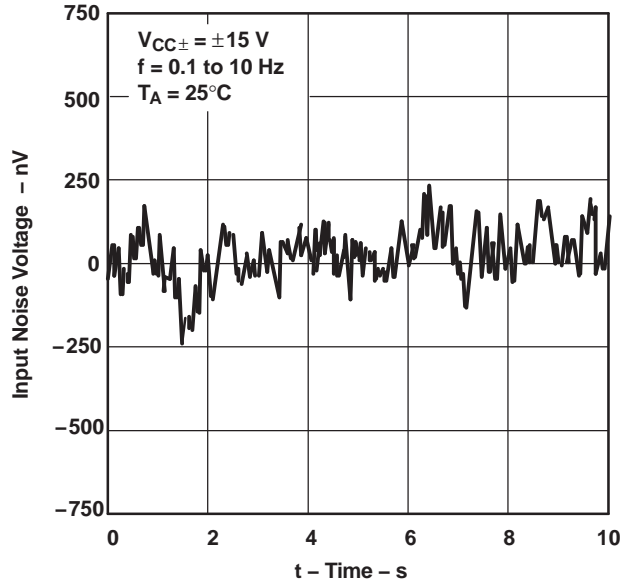

Figure 26.

TOTAL HARMONIC DISTORTION
PLUS NOISE
vs
FREQUENCY

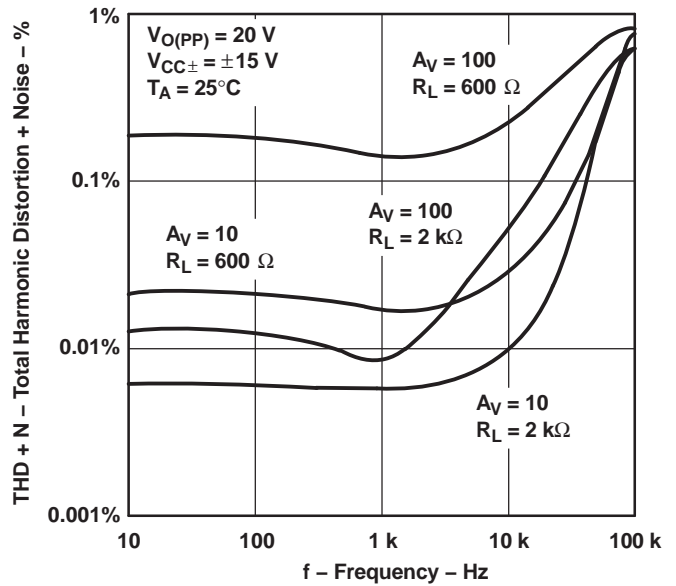
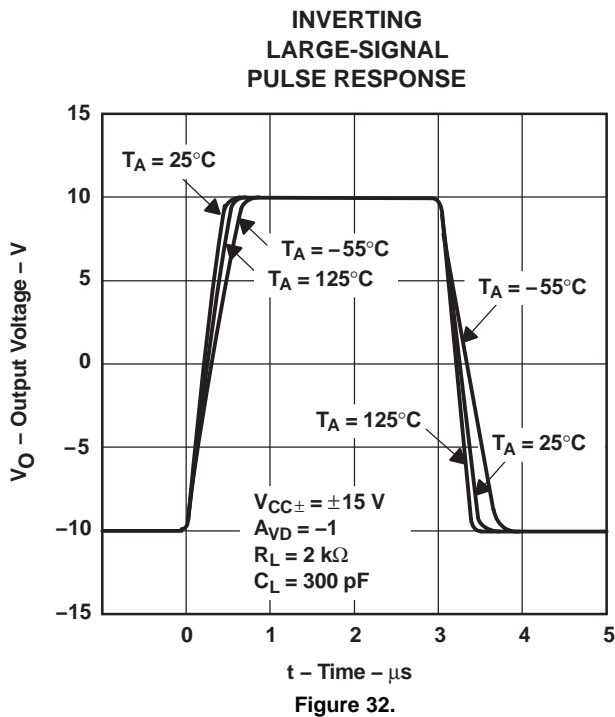
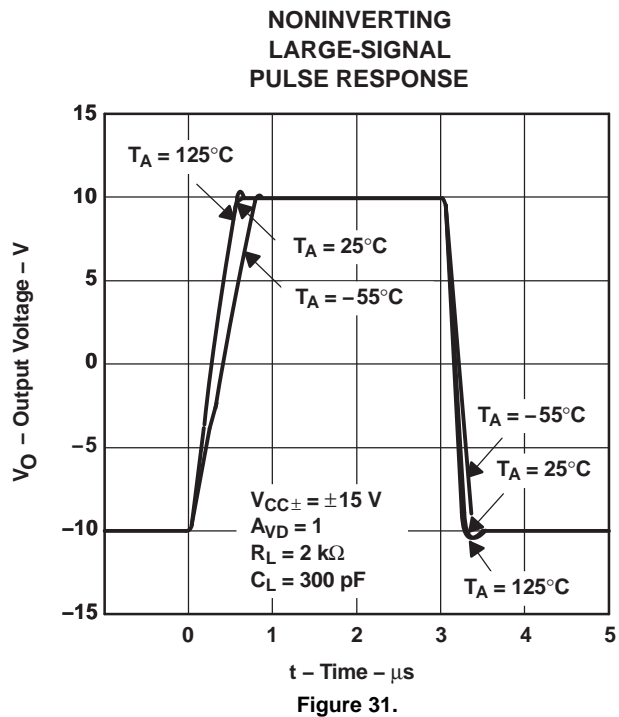
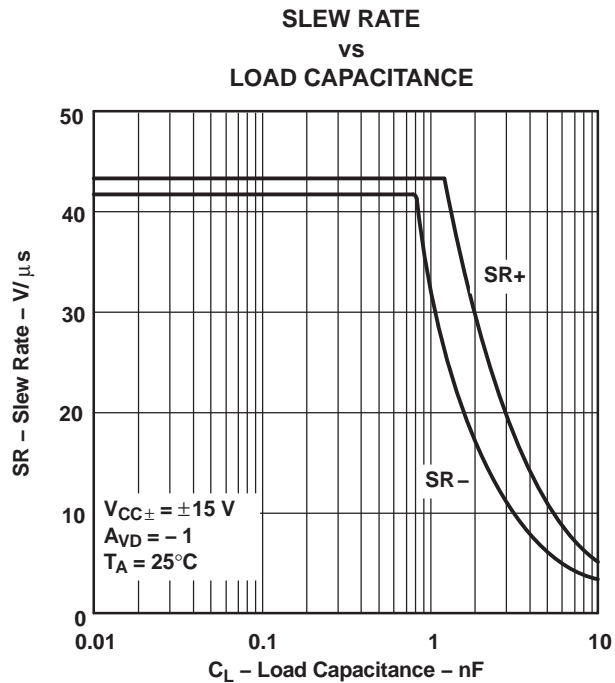
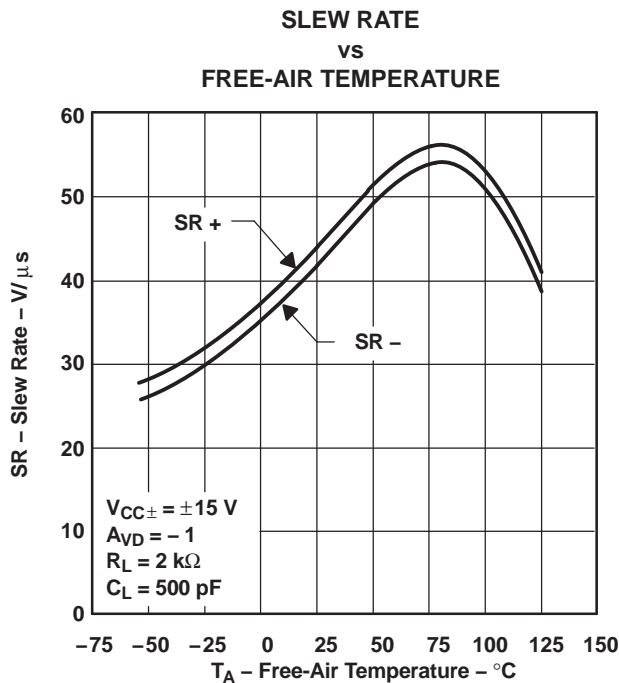
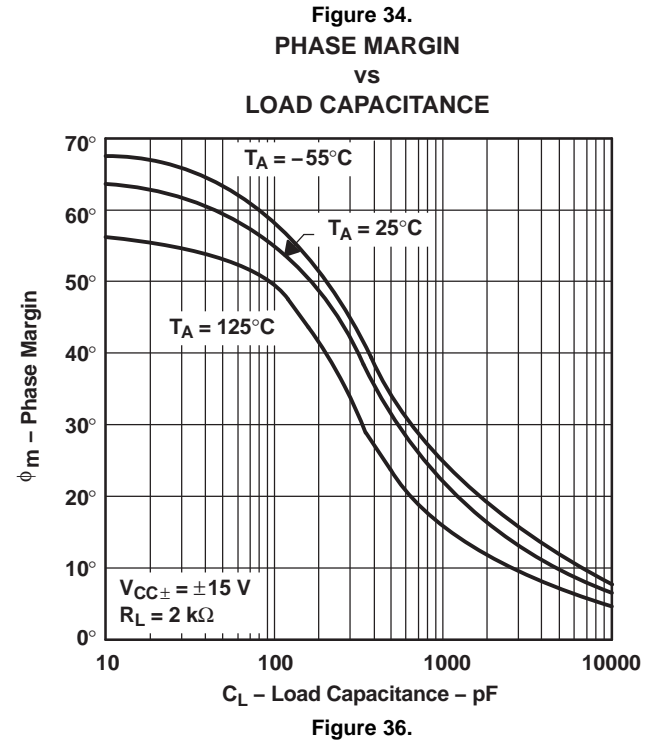
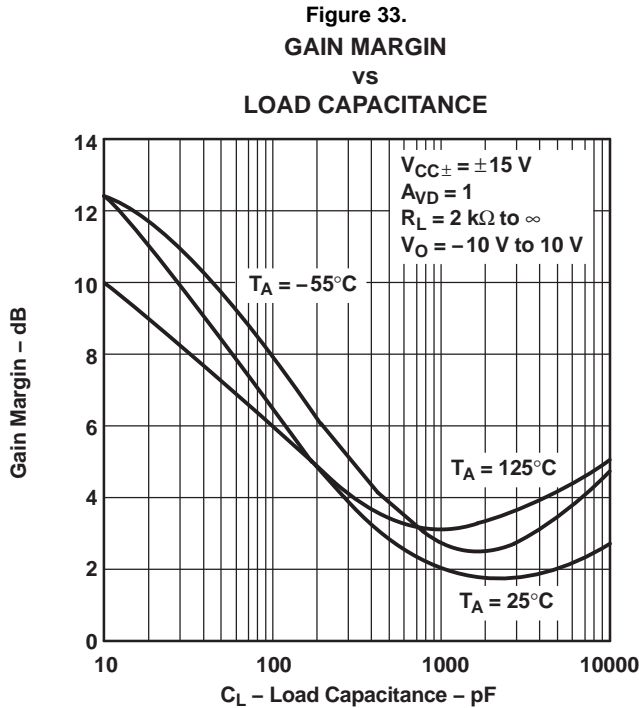
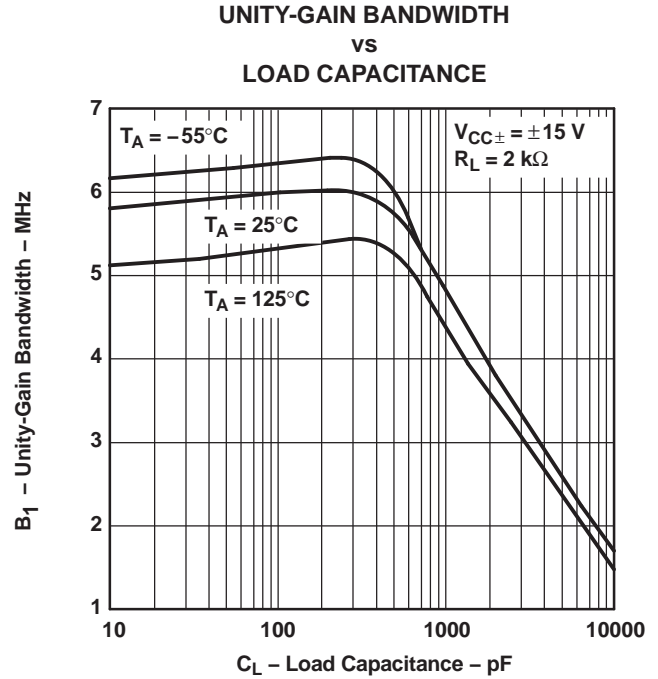
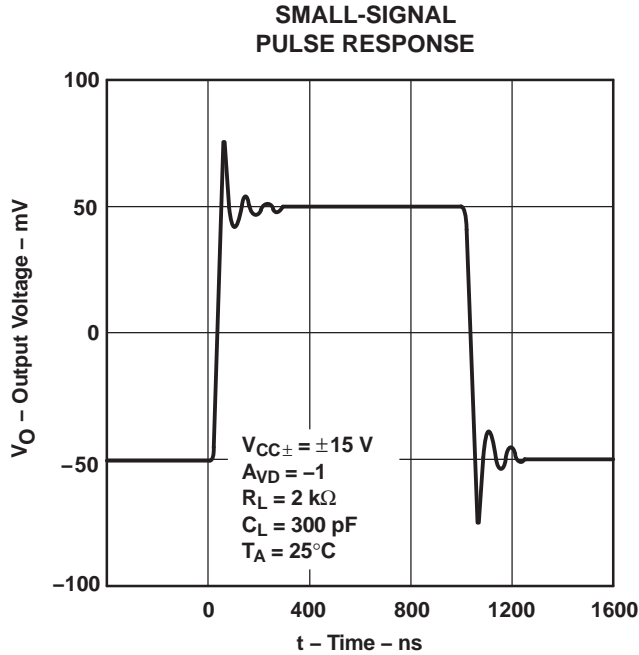

Figure 28.





APPLICATION INFORMATION

Input Offset Voltage Nulling

The TLE2141 offers external null pins that can be used to further reduce the input offset voltage. If this feature is desired, connect the circuit of [Figure 37](#) as shown. If external nulling is not needed, the null pins may be left unconnected.

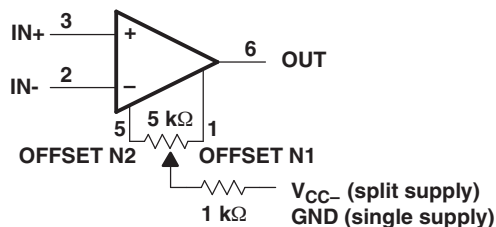

Figure 37. Input Offset Voltage Null Circuit

TAPE AND REEL INFORMATION

QUADRANT ASSIGNMENTS FOR PIN 1 ORIENTATION IN TAPE

*All dimensions are nominal

Device	Package Type	Package Drawing	Pins	SPQ	Reel Diameter (mm)	Reel Width W1 (mm)	A0 (mm)	B0 (mm)	K0 (mm)	P1 (mm)	W (mm)	Pin1 Quadrant
TLE2141MDREP	SOIC	D	8	2500	330.0	12.4	6.4	5.2	2.1	8.0	12.0	Q1
TLE2144MDWREP	SOIC	DW	16	2000	330.0	16.4	10.75	10.7	2.7	12.0	16.0	Q1

TAPE AND REEL BOX DIMENSIONS

*All dimensions are nominal

Device	Package Type	Package Drawing	Pins	SPQ	Length (mm)	Width (mm)	Height (mm)
TLE2141MDREP	SOIC	D	8	2500	340.5	336.1	25.0
TLE2144MDWREP	SOIC	DW	16	2000	350.0	350.0	43.0

GENERIC PACKAGE VIEW

DW 16

SOIC - 2.65 mm max height

7.5 x 10.3, 1.27 mm pitch

SMALL OUTLINE INTEGRATED CIRCUIT

This image is a representation of the package family, actual package may vary.
Refer to the product data sheet for package details.

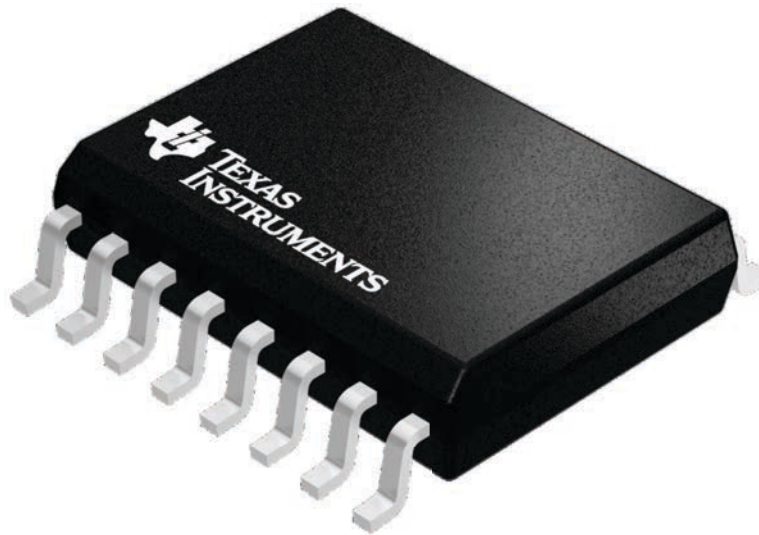

4224780/A

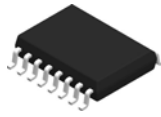

DW0016A

PACKAGE OUTLINE

SOIC - 2.65 mm max height

SOIC

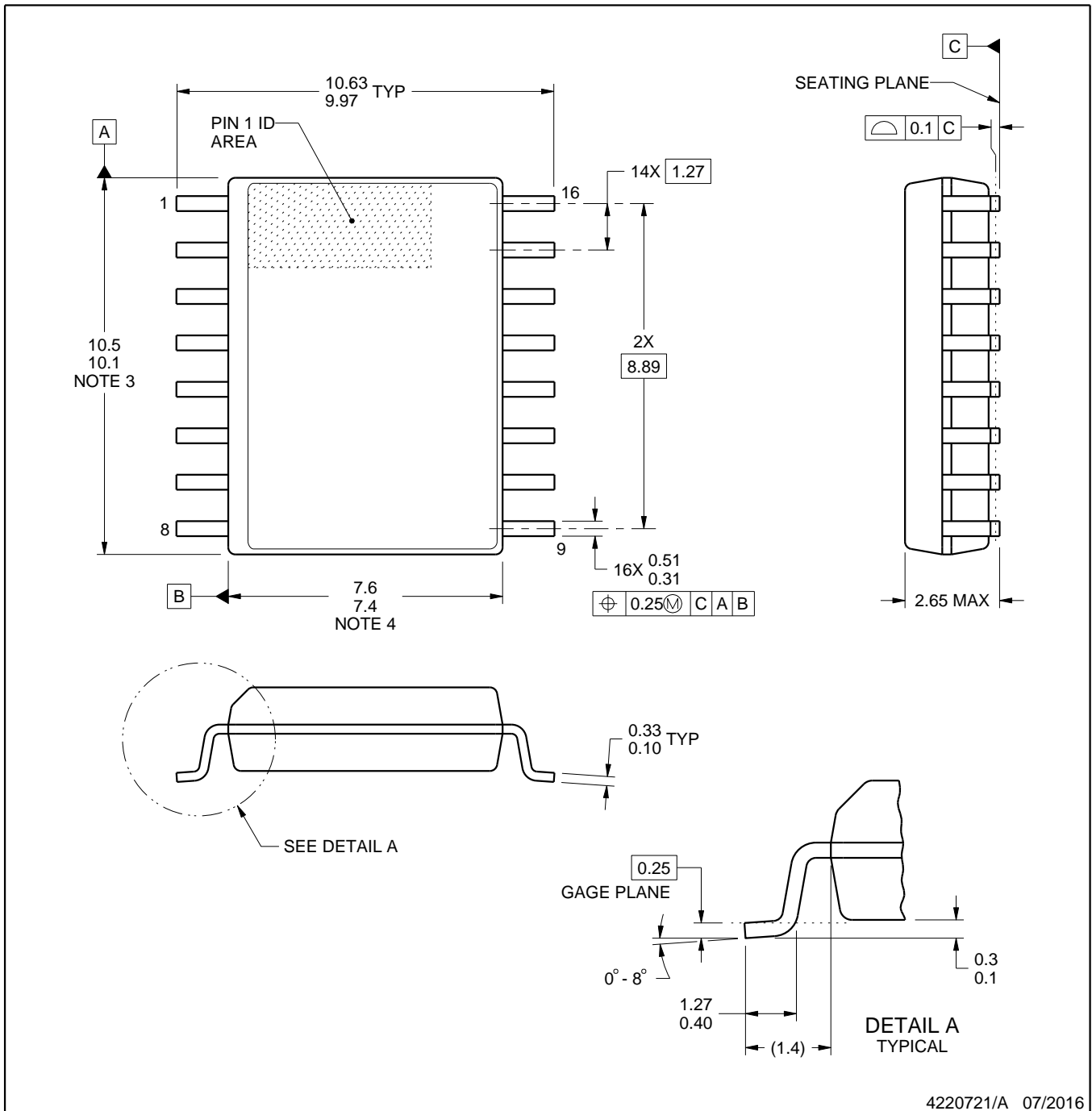

4220721/A 07/2016

NOTES:

1. All linear dimensions are in millimeters. Dimensions in parenthesis are for reference only. Dimensioning and tolerancing per ASME Y14.5M.
2. This drawing is subject to change without notice.
3. This dimension does not include mold flash, protrusions, or gate burrs. Mold flash, protrusions, or gate burrs shall not exceed 0.15 mm, per side.
4. This dimension does not include interlead flash. Interlead flash shall not exceed 0.25 mm, per side.
5. Reference JEDEC registration MS-013.

EXAMPLE BOARD LAYOUT

DW0016A

SOIC - 2.65 mm max height

SOIC

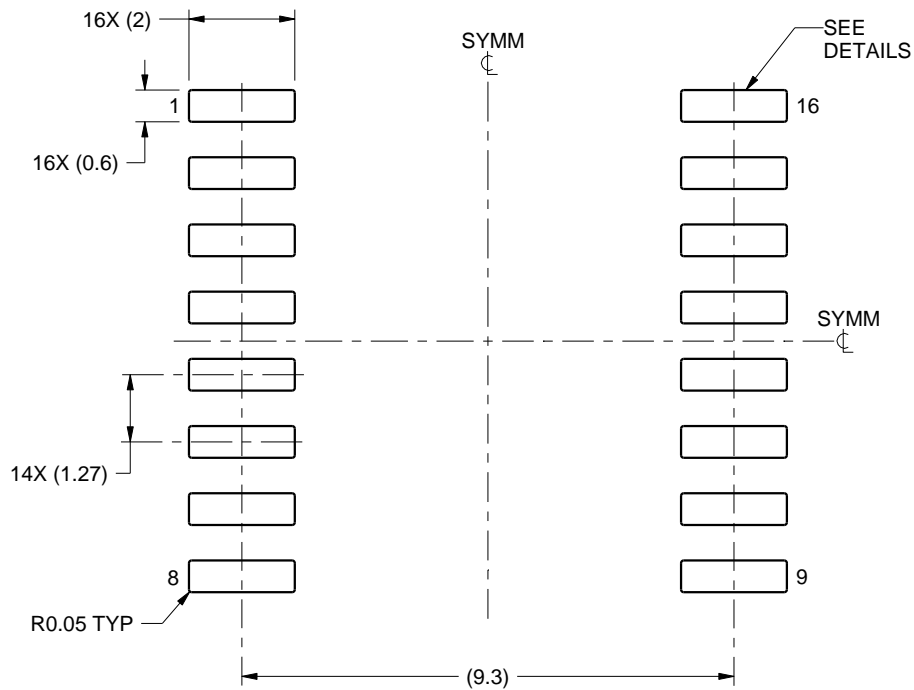

LAND PATTERN EXAMPLE
SCALE:7X

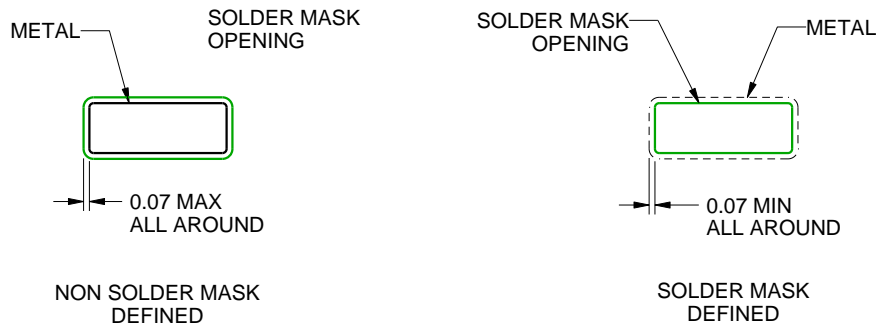

SOLDER MASK DETAILS

4220721/A 07/2016

NOTES: (continued)

6. Publication IPC-7351 may have alternate designs.

7. Solder mask tolerances between and around signal pads can vary based on board fabrication site.

EXAMPLE STENCIL DESIGN

DW0016A

SOIC - 2.65 mm max height

SOIC

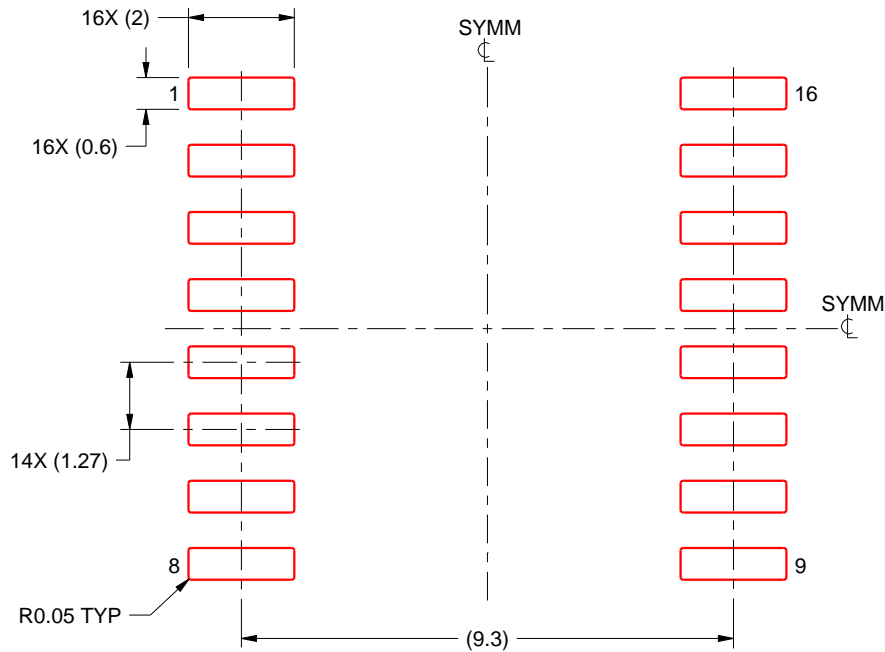

SOLDER PASTE EXAMPLE
BASED ON 0.125 mm THICK STENCIL
SCALE:7X

4220721/A 07/2016

NOTES: (continued)

8. Laser cutting apertures with trapezoidal walls and rounded corners may offer better paste release. IPC-7525 may have alternate design recommendations.
9. Board assembly site may have different recommendations for stencil design.



D0008A

PACKAGE OUTLINE

SOIC - 1.75 mm max height

SMALL OUTLINE INTEGRATED CIRCUIT



4214825/C 02/2019

NOTES:

1. Linear dimensions are in inches [millimeters]. Dimensions in parenthesis are for reference only. Controlling dimensions are in inches. Dimensioning and tolerancing per ASME Y14.5M.
2. This drawing is subject to change without notice.
3. This dimension does not include mold flash, protrusions, or gate burrs. Mold flash, protrusions, or gate burrs shall not exceed .006 [0.15] per side.
4. This dimension does not include interlead flash.
5. Reference JEDEC registration MS-012, variation AA.

EXAMPLE BOARD LAYOUT

D0008A

SOIC - 1.75 mm max height

SMALL OUTLINE INTEGRATED CIRCUIT



LAND PATTERN EXAMPLE
EXPOSED METAL SHOWN
SCALE:8X



SOLDER MASK DETAILS

4214825/C 02/2019

NOTES: (continued)

- 6. Publication IPC-7351 may have alternate designs.
- 7. Solder mask tolerances between and around signal pads can vary based on board fabrication site.

EXAMPLE STENCIL DESIGN

D0008A

SOIC - 1.75 mm max height

SMALL OUTLINE INTEGRATED CIRCUIT



SOLDER PASTE EXAMPLE
BASED ON .005 INCH [0.125 MM] THICK STENCIL
SCALE:8X

4214825/C 02/2019

NOTES: (continued)

8. Laser cutting apertures with trapezoidal walls and rounded corners may offer better paste release. IPC-7525 may have alternate design recommendations.
9. Board assembly site may have different recommendations for stencil design.

IMPORTANT NOTICE AND DISCLAIMER

TI PROVIDES TECHNICAL AND RELIABILITY DATA (INCLUDING DATASHEETS), DESIGN RESOURCES (INCLUDING REFERENCE DESIGNS), APPLICATION OR OTHER DESIGN ADVICE, WEB TOOLS, SAFETY INFORMATION, AND OTHER RESOURCES "AS IS" AND WITH ALL FAULTS, AND DISCLAIMS ALL WARRANTIES, EXPRESS AND IMPLIED, INCLUDING WITHOUT LIMITATION ANY IMPLIED WARRANTIES OF MERCHANTABILITY, FITNESS FOR A PARTICULAR PURPOSE OR NON-INFRINGEMENT OF THIRD PARTY INTELLECTUAL PROPERTY RIGHTS.

These resources are intended for skilled developers designing with TI products. You are solely responsible for (1) selecting the appropriate TI products for your application, (2) designing, validating and testing your application, and (3) ensuring your application meets applicable standards, and any other safety, security, or other requirements. These resources are subject to change without notice. TI grants you permission to use these resources only for development of an application that uses the TI products described in the resource. Other reproduction and display of these resources is prohibited. No license is granted to any other TI intellectual property right or to any third party intellectual property right. TI disclaims responsibility for, and you will fully indemnify TI and its representatives against, any claims, damages, costs, losses, and liabilities arising out of your use of these resources.

TI's products are provided subject to TI's Terms of Sale (<https://www.ti.com/legal/termsofsale.html>) or other applicable terms available either on [ti.com](https://www.ti.com) or provided in conjunction with such TI products. TI's provision of these resources does not expand or otherwise alter TI's applicable warranties or warranty disclaimers for TI products.

Mailing Address: Texas Instruments, Post Office Box 655303, Dallas, Texas 75265
Copyright © 2021, Texas Instruments Incorporated