

SN74AUP1T97 具有九个可配置门逻辑功能的 单电源电压电平转换器

1 特性

- 可采用德州仪器 (TI) 的 NanoStar™ 封装
- 单电源电压转换器
- 1.8V 至 3.3V ($V_{CC}=3.3V$ 时)
- 2.5V 至 3.3V ($V_{CC}=3.3V$ 时)
- 1.8V 至 2.5V ($V_{CC}=2.5V$ 时)
- 3.3V 至 2.5V ($V_{CC} = 2.5V$ 时)
- 九个可配置的门逻辑功能
- 施密特触发器输入可抑制输入噪声并提供更佳的输出信号完整性
- I_{off} 支持局部断电模式, 具有低泄漏电流 (0.5 μ A)
- 超低的静态和动态功耗
- 可提供无铅封装: SON (DRY 或 DSF)、SOT-23 (DBV)、SC-70 (DCK) 和 NanoStar WCSP
- 闩锁性能超过 100mA, 符合 JESD 78 II 类规范的要求
- 静电放电 (ESD) 性能测试符合 JESD 22 标准
 - 2000V 人体放电模型{13} (A114-B, II 类)
 - 1000V 充电器件模型 (C101)
- 相关器件: SN74AUP1T98、SN74AUP1T57 和 SN74AUP1T58

2 说明

AUP 技术是业内功耗超低的逻辑技术, 适用于电池供电或带有备用电池的设备。SN74AUP1T97 专门用于逻辑电平转换应用, 其输入转换电平可接受 1.8V 的 LVCMOS 信号, 同时可由单个 3.3V 或 2.5V V_{CC} 电源供电。

利用 2.3V 至 3.6V 的宽 V_{CC} 范围, 可在系统运行期间实现电池压降, 并确保在该范围内正常运行。

施密特触发器输入 (正负输入转换之间的 $\Delta V_T=210mV$) 改进了开关转换期间的抗扰度, 这对于模拟混合模式设计十分有用。施密特触发器输入抑制输入噪声、确保输出信号的完整性并可实现慢输入信号转换。

通过将 A、B 和 C 输入连接到 V_{CC} 或接地, 可轻松将 SN74AUP1T97 配置为执行所需的门功能 (请参阅功能选择表)。最多可执行九个常用的逻辑门功能。

$I_{关闭}$ 特性可实现省电条件 ($V_{CC}=0V$), 这在便携式和移动应用中十分重要。当 $V_{CC}=0V$ 时, 介于 0V 至 3.6V 范围内的信号可被施加到器件的输入和输出上。在这些条件下, 不会对器件造成损坏。

SN74AUP1T97 经设计优化具有 4mA 电流驱动能力, 可减少由高驱动输出导致的线路反射、过冲和下冲。

NanoStar 封装技术是 IC 封装概念的一项重大突破, 它将硅晶片用作封装。

器件信息

器件型号	封装 ⁽¹⁾	封装尺寸 (标称值)
SN74AUP1T97DBV	SOT-23 (6)	2.9mm x 1.6mm
SN74AUP1T97DCK	SC70 (6)	2.0mm x 1.25mm
SN74AUP1T97DRY	SON (6)	1.45mm x 1.0mm
SN74AUP1T97DSF	SON (6)	1.0mm x 1.0mm
SN74AUP1T97YFP	DSBGA (6)	1.0mm x 1.4mm
SN74AUP1T97YZP	DSBGA (6)	1.75mm x 1.25mm

(1) 如需了解所有可用封装, 请参阅数据表末尾的可订购产品附录。

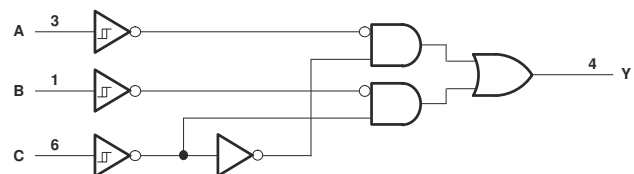

逻辑图 (正逻辑)



Table of Contents

1 特性	1	5.12 Switching Characteristics.....	7
2 说明	1	5.13 Operating Characteristics.....	8
3 Revision History	2	5.14 Typical Characteristics.....	8
4 Pin Configuration and Functions	3	6 Parameter Measurement Information	9
5 Specifications	4	7 Detailed Description	10
5.1 Absolute Maximum Ratings.....	4	7.1 Functional Block Diagram.....	10
5.2 ESD Ratings.....	4	7.2 Feature Description.....	10
5.3 Recommended Operating Conditions.....	4	7.3 Device Functional Modes.....	11
5.4 Thermal Information.....	5	8 Device and Documentation Support	13
5.5 Thermal Information.....	5	8.1 Documentation Support.....	13
5.6 Electrical Characteristics.....	5	8.2 Receiving Notification of Documentation Updates... 13	
5.7 Switching Characteristics.....	6	8.3 Support Resources.....	13
5.8 Switching Characteristics.....	6	8.4 Trademarks.....	13
5.9 Switching Characteristics.....	6	8.5 Glossary.....	13
5.10 Switching Characteristics.....	7	9 Mechanical, Packaging, and Orderable Information..	13
5.11 Switching Characteristics.....	7		

3 Revision History

注：以前版本的页码可能与当前版本的页码不同

Changes from Revision I (May 2010) to Revision J (September 2020)	Page
• 添加了器件信息表、ESD 等级表、特性说明部分、器件功能模式部分、器件和文档支持部分以及机械、封装和可订购信息部分.....	1
• 删除了器件信息表，请参阅数据表末尾的机械、封装和可订购信息.....	1
• 更新了整个文档的表、图和交叉参考的编号格式.....	1

4 Pin Configuration and Functions



图 4-1. DBV OR DCK Package 6-Pin SOT-23 or SC70 Top View



图 4-2. DRY OR DSF Package 6-Pin SON Top View

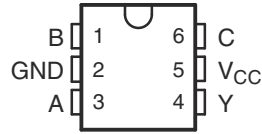

图 4-3. YFP OR YZP Package 6-Pin DSBGA Top View

5 Specifications

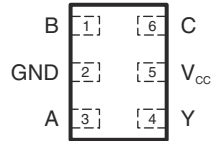
5.1 Absolute Maximum Ratings

over operating free-air temperature range (unless otherwise noted)⁽¹⁾

			MIN	MAX	UNIT
V _{CC}	Supply voltage		- 0.5	4.6	V
V _I	Input voltage ⁽²⁾		- 0.5	4.6	V
V _O	Voltage range applied to any output in the high-impedance or power-off state ⁽²⁾		- 0.5	4.6	V
V _O	Output voltage range in the high or low state ⁽²⁾		- 0.5	V _{CC} + 0.5	V
I _{IK}	Input clamp current	V _I < 0		- 50	mA
I _{OK}	Output clamp current	V _O < 0		- 50	mA
I _O	Continuous output current			±20	mA
	Continuous current through V _{CC} or GND			±50	mA
T _{stg}	Storage temperature		- 65	150	°C

(1) Stresses beyond those listed under "absolute maximum ratings" may cause permanent damage to the device. These are stress ratings only, and functional operation of the device at these or any other conditions beyond those indicated under "recommended operating conditions" is not implied. Exposure to absolute-maximum-rated conditions for extended periods may affect device reliability.

(2) The input negative-voltage and output voltage ratings may be exceeded if the input and output current ratings are observed.

5.2 ESD Ratings

			VALUE	UNIT
V _(ESD)	Electrostatic discharge	Human-body model (HBM), per ANSI/ESDA/JEDEC JS-001 ⁽¹⁾	2000	V
		Charged-device model (CDM), per JEDEC specification JESD22-C101 ⁽²⁾	1000	

(1) JEDEC document JEP155 states that 500-V HBM allows safe manufacturing with a standard ESD control process.

(2) JEDEC document JEP157 states that 250-V CDM allows safe manufacturing with a standard ESD control process.

5.3 Recommended Operating Conditions

See⁽¹⁾

			MIN	MAX	UNIT
V _{CC}	Supply voltage		2.3	3.6	V
V _I	Input voltage		0	3.6	V
V _O	Output voltage		0	V _{CC}	V
I _{OH}	High-level output current	V _{CC} = 2.3 V		- 3.1	mA
		V _{CC} = 3 V		- 4	
I _{OL}	Low-level output current	V _{CC} = 2.3 V		3.1	mA
		V _{CC} = 3 V		4	
T _A	Operating free-air temperature		- 40	85	°C

(1) All unused inputs of the device must be held at V_{CC} or GND to ensure proper device operation. See [Implications of Slow or Floating CMOS Inputs](#), SCBA004.

5.4 Thermal Information

THERMAL METRIC ⁽¹⁾	SN74AUP1T97				UNIT
	DBV (SOT-23)	DCK (SC70)	DRY (SON)	DSF (SON)	
	6 PINS	6 PINS	6 PINS	6 PINS	
R _{θJA} Junction-to-ambient thermal resistance	165	259	340	300	°C/W
R _{θJC(top)} Junction-to-case (top) thermal resistance					°C/W
R _{θJB} Junction-to-board thermal resistance					°C/W
ψ _{JT} Junction-to-top characterization parameter					°C/W
ψ _{JB} Junction-to-board characterization parameter					°C/W
R _{θJC(bot)} Junction-to-case (bottom) thermal resistance					°C/W

(1) For more information about traditional and new thermal metrics, see the [Semiconductor and IC Package Thermal Metrics](#) application report.

5.5 Thermal Information

THERMAL METRIC ⁽¹⁾	SN74AUP1T97		UNIT
	YFP (DSBGA)	YZP (DSBGA)	
	6 PINS	6 PINS	
R _{θJA} Junction-to-ambient thermal resistance	123	123	°C/W
R _{θJC(top)} Junction-to-case (top) thermal resistance			°C/W
R _{θJB} Junction-to-board thermal resistance			°C/W
ψ _{JT} Junction-to-top characterization parameter			°C/W
ψ _{JB} Junction-to-board characterization parameter			°C/W
R _{θJC(bot)} Junction-to-case (bottom) thermal resistance			°C/W

(1) For more information about traditional and new thermal metrics, see the [Semiconductor and IC Package Thermal Metrics](#) application report.

5.6 Electrical Characteristics

over recommended operating free-air temperature range (unless otherwise noted)

PARAMETER	TEST CONDITIONS	V _{CC}	T _A = 25°C			T _A = -40°C to 85°C		UNIT
			MIN	TYP	MAX	MIN	MAX	
V _{T+} Positive-going input threshold voltage		2.3 V to 2.7 V	0.6		1.1	0.6	1.1	V
		3 V to 3.6 V	0.75		1.16	0.75	1.19	
V _{T-} Negative-going input threshold voltage		2.3 V to 2.7 V	0.35		0.6	0.35	0.6	V
		3 V to 3.6 V	0.5		0.85	0.5	0.85	
ΔV _T Hysteresis (V _{T+} - V _{T-})		2.3 V to 2.7 V	0.23		0.6	0.1	0.6	V
		3 V to 3.6 V	0.25		0.56	0.15	0.56	
V _{OH}	I _{OH} = -20 μA	2.3 V to 3.6 V	V _{CC} - 0.1		V _{CC} - 0.1		V	
	I _{OH} = -2.3 mA	2.3 V	2.05		1.97			
	I _{OH} = -3.1 mA		1.9		1.85			
	I _{OH} = -2.7 mA	3 V	2.72		2.67			
	I _{OH} = -4 mA		2.6		2.55			
V _{OL}	I _{OL} = 20 μA	2.3 V to 3.6 V			0.1	0.1	V	

5.6 Electrical Characteristics (continued)

over recommended operating free-air temperature range (unless otherwise noted)

PARAMETER	TEST CONDITIONS	V _{CC}	T _A = 25°C			T _A = -40°C to 85°C		UNIT
			MIN	TYP	MAX	MIN	MAX	
	I _{OL} = 2.3 mA	2.3 V				0.31	0.33	
	I _{OL} = 3.1 mA					0.44	0.45	
	I _{OL} = 2.7 mA	3 V				0.31	0.33	
	I _{OL} = 4 mA					0.44	0.45	
I _I	All inputs V _I = 3.6 V or GND	0 V to 3.6 V				0.1	0.5	μA
I _{off}	V _I or V _O = 0 V to 3.6 V	0 V				0.1	0.5	μA
Δ I _{off}	V _I or V _O = 3.6 V	0 V to 0.2 V				0.2	0.5	μA
I _{CC}	V _I = 3.6 V or GND, I _O = 0	2.3 V to 3.6 V				0.5	0.9	μA
Δ I _{CC}	One input at 0.3 V or 1.1 V, Other inputs at 0 or V _{CC} , I _O = 0	2.3 V to 2.7 V					4	μA
	One input at 0.45 V or 1.2 V, Other inputs at 0 or V _{CC} , I _O = 0	3 V to 3.6 V					12	
C _i	V _I = V _{CC} or GND	3.3 V	1.5					pF
C _o	V _O = V _{CC} or GND	3.3 V	3					pF

5.7 Switching Characteristics

over recommended operating free-air temperature range, V_{CC} = 2.5 V ± 0.2 V, V_I = 1.8 V ± 0.15 V (unless otherwise noted) (see [Figure 6-1](#))

PARAMETER	FROM (INPUT)	TO (OUTPUT)	C _L	T _A = 25°C			T _A = -40°C to 85°C		UNIT
				MIN	TYP	MAX	MIN	MAX	
t _{pd}	A, B, or C	Y	5 pF	1.8	2.3	2.9	0.5	6.8	ns
			10 pF	2.3	2.8	3.4	1	7.9	
			15 pF	2.6	3.1	3.8	1	8.7	
			30 pF	3.8	4.4	5.1	1.5	10.8	

5.8 Switching Characteristics

over recommended operating free-air temperature range, V_{CC} = 2.5 V ± 0.2 V, V_I = 2.5 V ± 0.2 V (unless otherwise noted) (see [Figure 6-1](#))

PARAMETER	FROM (INPUT)	TO (OUTPUT)	C _L	T _A = 25°C			T _A = -40°C to 85°C		UNIT
				MIN	TYP	MAX	MIN	MAX	
t _{pd}	A, B, or C	Y	5 pF	1.8	2.3	3.1	0.5	6	ns
			10 pF	2.2	2.8	3.5	1	7.1	
			15 pF	2.6	3.2	5.2	1	7.9	
			30 pF	3.7	4.4	5.2	1.5	10	

5.9 Switching Characteristics

over recommended operating free-air temperature range, V_{CC} = 2.5 V ± 0.2 V, V_I = 3.3 V ± 0.3 V (unless otherwise noted) (see [Figure 6-1](#))

PARAMETER	FROM (INPUT)	TO (OUTPUT)	C _L	T _A = 25°C			T _A = -40°C to 85°C		UNIT
				MIN	TYP	MAX	MIN	MAX	
t _{pd}	A, B, or C	Y	5 pF	2	2.7	3.5	0.5	5.5	ns

5.9 Switching Characteristics (continued)

over recommended operating free-air temperature range, $V_{CC} = 2.5\text{ V} \pm 0.2\text{ V}$, $V_I = 3.3\text{ V} \pm 0.3\text{ V}$ (unless otherwise noted) (see [Figure 6-1](#))

PARAMETER	FROM (INPUT)	TO (OUTPUT)	C_L	$T_A = 25^\circ\text{C}$			$T_A = -40^\circ\text{C}$ to 85°C		UNIT
				MIN	TYP	MAX	MIN	MAX	
			10 pF	2.4	3.1	3.9	1	6.5	
			15 pF	2.8	3.5	4.3	1	7.4	
			30 pF	4	4.7	5.5	1.5	9.5	

5.10 Switching Characteristics

over recommended operating free-air temperature range, $V_{CC} = 3.3\text{ V} \pm 0.3\text{ V}$, $V_I = 1.8\text{ V} \pm 0.15\text{ V}$ (unless otherwise noted) (see [Figure 6-1](#))

PARAMETER	FROM (INPUT)	TO (OUTPUT)	C_L	$T_A = 25^\circ\text{C}$			$T_A = -40^\circ\text{C}$ to 85°C		UNIT
				MIN	TYP	MAX	MIN	MAX	
t_{pd}	A, B, or C	Y	5 pF	1.6	2	2.5	0.5	8	ns
			10 pF	2	2.4	2.9	1	8.5	
			15 pF	2.3	2.8	3.3	1	9.1	
			30 pF	3.4	3.9	4.4	1.5	9.8	

5.11 Switching Characteristics

over recommended operating free-air temperature range, $V_{CC} = 3.3\text{ V} \pm 0.3\text{ V}$, $V_I = 2.5\text{ V} \pm 0.2\text{ V}$ (unless otherwise noted) (see [Figure 6-1](#))

PARAMETER	FROM (INPUT)	TO (OUTPUT)	C_L	$T_A = 25^\circ\text{C}$			$T_A = -40^\circ\text{C}$ to 85°C		UNIT
				MIN	TYP	MAX	MIN	MAX	
t_{pd}	A, B, or C	Y	5 pF	1.6	1.9	2.4	0.5	5.3	ns
			10 pF	2	2.3	2.7	1	6.1	
			15 pF	2.3	2.7	3.1	1	6.8	
			30 pF	3.4	3.8	4.2	1.5	8.5	

5.12 Switching Characteristics

over recommended operating free-air temperature range, $V_{CC} = 3.3\text{ V} \pm 0.3\text{ V}$, $V_I = 3.3\text{ V} \pm 0.3\text{ V}$ (unless otherwise noted) (see [Figure 6-1](#))

PARAMETER	FROM (INPUT)	TO (OUTPUT)	C_L	$T_A = 25^\circ\text{C}$			$T_A = -40^\circ\text{C}$ to 85°C		UNIT
				MIN	TYP	MAX	MIN	MAX	
t_{pd}	A, B, or C	Y	5 pF	1.6	2.1	2.7	0.5	4.7	ns
			10 pF	2	2.4	3	1	5.7	
			15 pF	2.3	2.7	3.3	1	6.2	
			30 pF	3.4	3.8	4.4	1.5	7.8	

5.13 Operating Characteristics

 $T_A = 25^\circ\text{C}$

PARAMETER	TEST CONDITIONS	$V_{CC} = 2.5\text{ V}$	$V_{CC} = 3.3\text{ V}$	UNIT
		TYP	TYP	
C_{pd} Power dissipation capacitance	$f = 10\text{ MHz}$	4	5	pF

5.14 Typical Characteristics

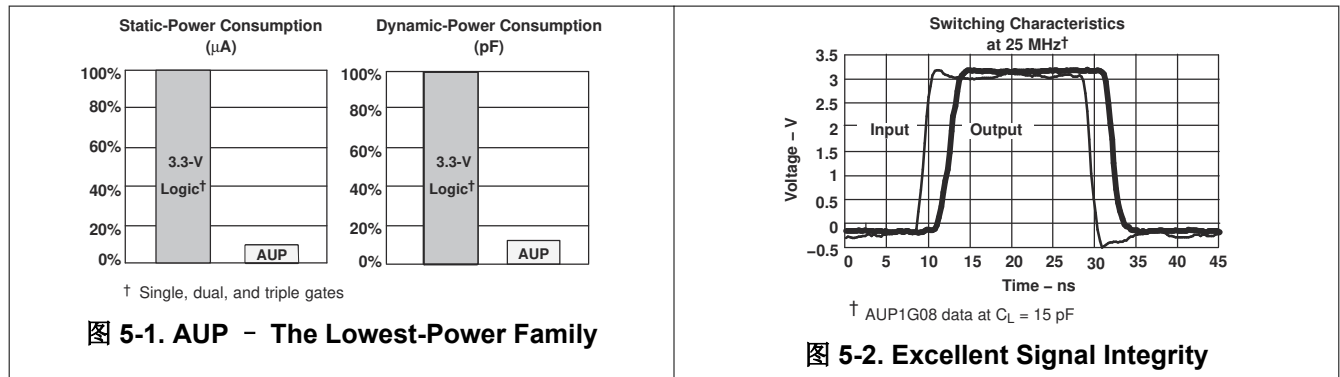

6 Parameter Measurement Information

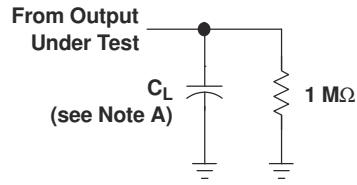

LOAD CIRCUIT

	$V_{CC} = 2.5\text{ V}$ $\pm 0.2\text{ V}$	$V_{CC} = 3.3\text{ V}$ $\pm 0.3\text{ V}$
C_L	5, 10, 15, 30 pF	5, 10, 15, 30 pF
V_{MI}	$V_I/2$	$V_I/2$
V_{MO}	$V_{CC}/2$	$V_{CC}/2$

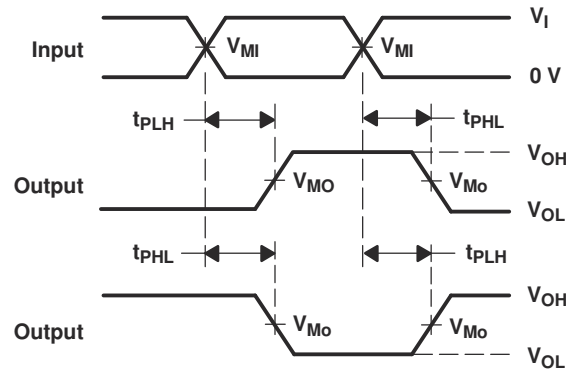

VOLTAGE WAVEFORMS
PROPAGATION DELAY TIMES
INVERTING AND NONINVERTING OUTPUTS

- NOTES: A. C_L includes probe and jig capacitance.
 B. All input pulses are supplied by generators having the following characteristics: PRR ≤ 10 MHz, $Z_O = 50\ \Omega$, slew rate ≥ 1 V/ns.
 C. The outputs are measured one at a time, with one transition per measurement.
 D. t_{PLH} and t_{PHL} are the same as t_{pd} .

图 6-1. Load Circuit and Voltage Waveforms

7 Detailed Description

7.1 Functional Block Diagram



图 7-1. Logic Diagram (Positive Logic)

7.2 Feature Description



图 7-2. Possible Voltage-Translation Combinations

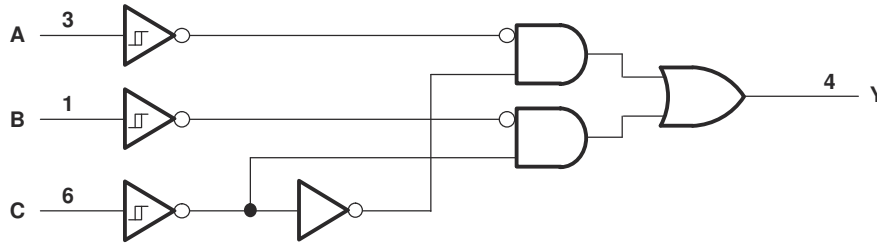

图 7-3. Switching Thresholds for 1.8-V to 3.3-V Translation

7.3 Device Functional Modes

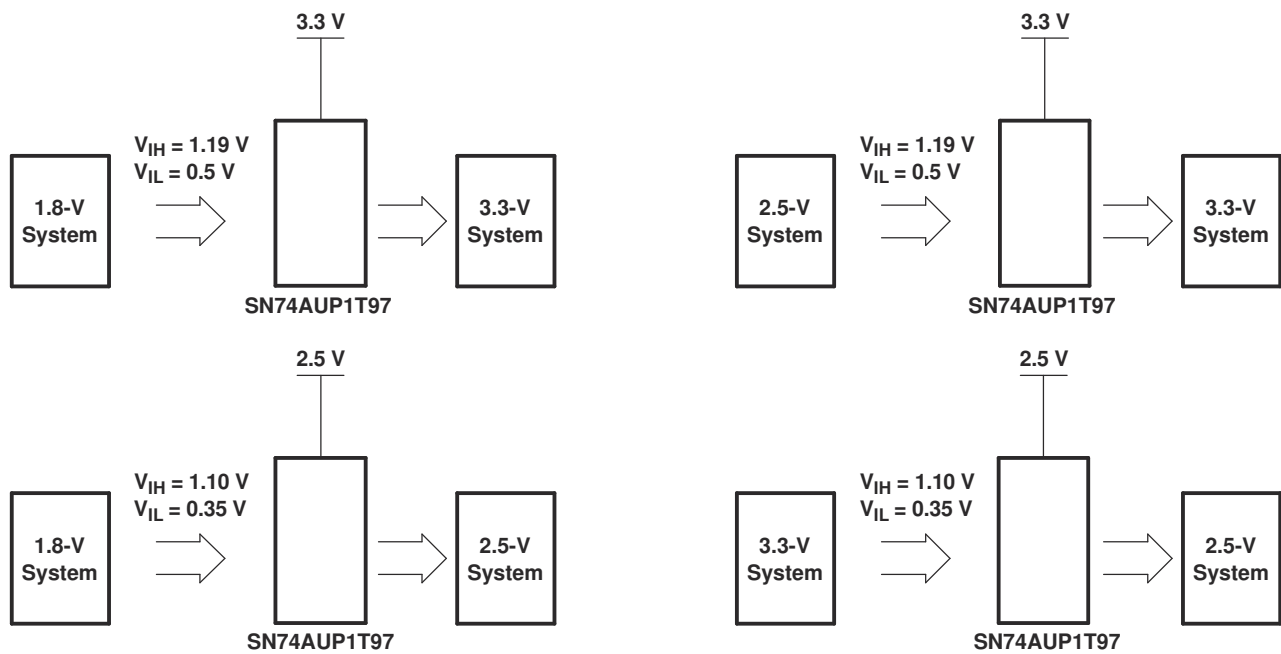
表 7-1 lists the functional modes of the SN74AUP1T97.

Table 7-1. Function Table

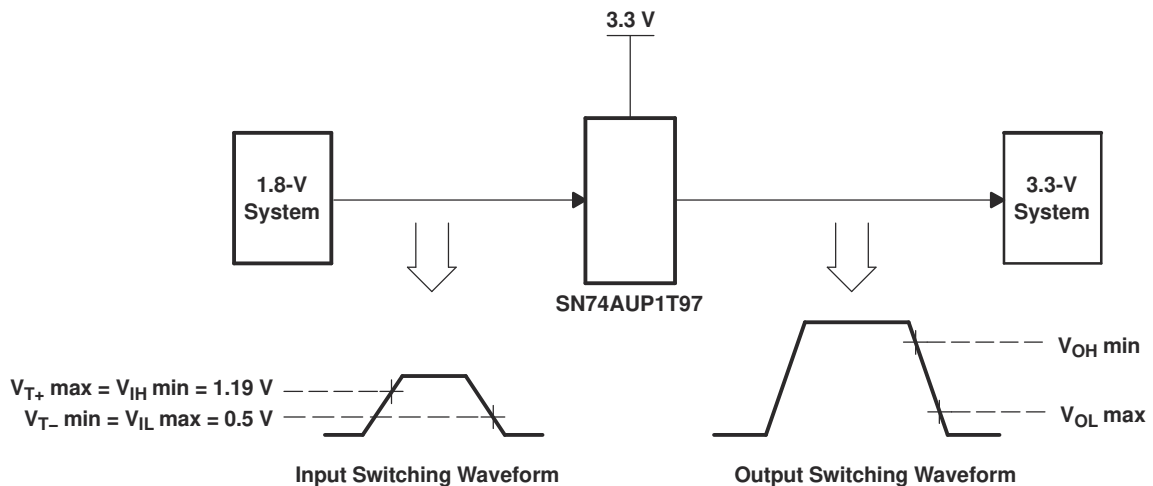
INPUTS			OUTPUT Y
C	B	A	
L	L	L	L
L	L	H	L
L	H	L	H
L	H	H	H
H	L	L	L
H	L	H	H
H	H	L	L
H	H	H	H

7.3.1 Logic Configurations

Table 7-2. Function Selection Table

LOGIC FUNCTION	FIGURE NO.
2-to-1 data selector	7-4
2-input AND gate	7-5
2-input OR gate with one inverted input	7-6
2-input NAND gate with one inverted input	7-6
2-input AND gate with one inverted input	7-7
2-input NOR gate with one inverted input	7-7
2-input OR gate	7-8
Inverter	7-9
Noninverted buffer	7-10



图 7-4. 157: 2-to-1 Data Selector/MUX
When C is L, Y = B
When C is H, Y = A



图 7-5. 08: 2-Input AND Gate

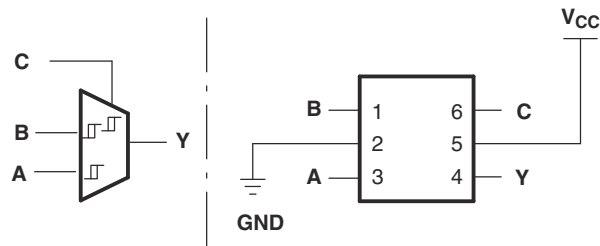

图 7-6. 14+32/14+00: 2-Input OR/NAND Gate With One Inverted Input

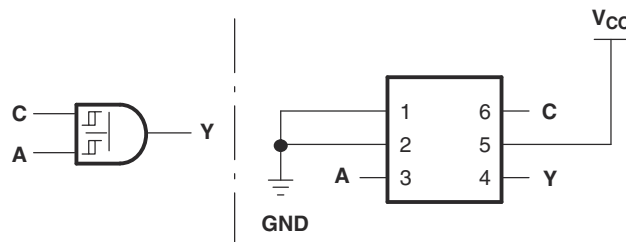

图 7-7. 14+08/14+02: 2-Input AND/NOR Gate With One Inverted Input

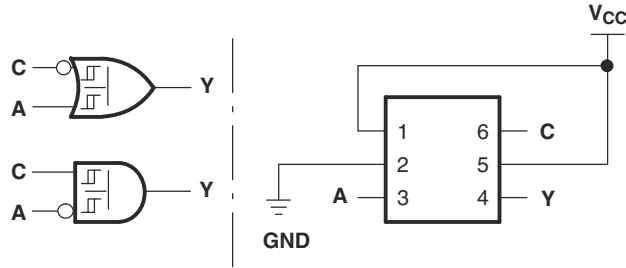

图 7-8. 32: 2-Input OR Gate

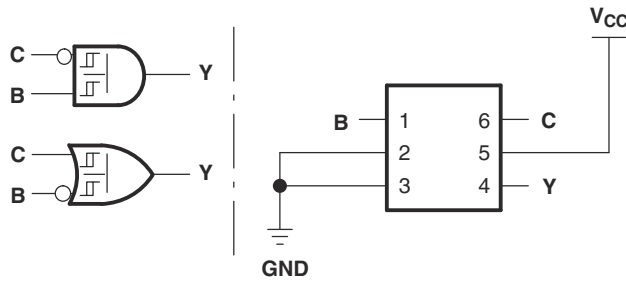

图 7-9. 04/14: Inverter

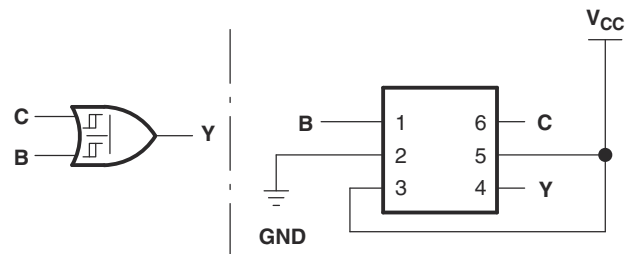

图 7-10. 17/34: Noninverted Buffer

8 Device and Documentation Support

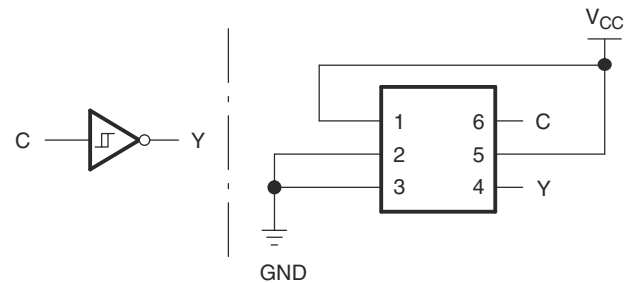
8.1 Documentation Support

8.1.1 Related Documentation

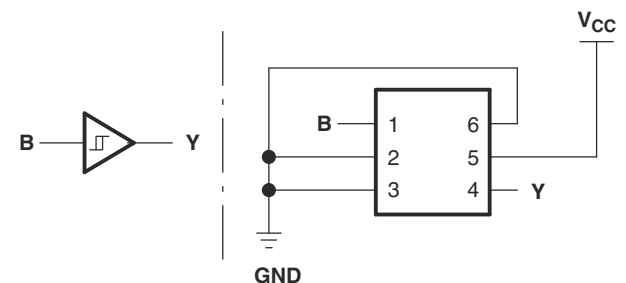
For related documentation see the following:

[Implications of Slow or Floating CMOS Inputs](#), SCBA004

8.2 Receiving Notification of Documentation Updates

To receive notification of documentation updates, navigate to the device product folder on [ti.com](#). Click on *Subscribe to updates* to register and receive a weekly digest of any product information that has changed. For change details, review the revision history included in any revised document.

8.3 Support Resources

[TI E2E™ support forums](#) are an engineer's go-to source for fast, verified answers and design help — straight from the experts. Search existing answers or ask your own question to get the quick design help you need.

Linked content is provided "AS IS" by the respective contributors. They do not constitute TI specifications and do not necessarily reflect TI's views; see TI's [Terms of Use](#).

8.4 Trademarks

NanoStar™ and TI E2E™ are trademarks of Texas Instruments.

所有商标均为其各自所有者的财产。

8.5 Glossary

[TI Glossary](#) This glossary lists and explains terms, acronyms, and definitions.

9 Mechanical, Packaging, and Orderable Information

The following pages include mechanical, packaging, and orderable information. This information is the most current data available for the designated devices. This data is subject to change without notice and revision of this document. For browser-based versions of this data sheet, refer to the left-hand navigation.

PACKAGING INFORMATION

Orderable Device	Status (1)	Package Type	Package Drawing	Pins	Package Qty	Eco Plan (2)	Lead finish/ Ball material (6)	MSL Peak Temp (3)	Op Temp (°C)	Device Marking (4/5)	Samples
SN74AUP1T97DBVR	ACTIVE	SOT-23	DBV	6	3000	RoHS & Green	NIPDAU	Level-1-260C-UNLIM	-40 to 85	HT4R	Samples
SN74AUP1T97DBVT	ACTIVE	SOT-23	DBV	6	250	RoHS & Green	NIPDAU	Level-1-260C-UNLIM	-40 to 85	(HT4F, HT4R)	Samples
SN74AUP1T97DCKR	ACTIVE	SC70	DCK	6	3000	RoHS & Green	NIPDAU	Level-1-260C-UNLIM	-40 to 85	(THF, THR)	Samples
SN74AUP1T97DCKRG4	ACTIVE	SC70	DCK	6	3000	RoHS & Green	NIPDAU	Level-1-260C-UNLIM	-40 to 85	(THF, THR)	Samples
SN74AUP1T97DRYR	ACTIVE	SON	DRY	6	5000	RoHS & Green	NIPDAUAG	Level-1-260C-UNLIM	-40 to 85	TH	Samples
SN74AUP1T97DSFR	ACTIVE	SON	DSF	6	5000	RoHS & Green	NIPDAU NIPDAUAG	Level-1-260C-UNLIM	-40 to 85	TH	Samples
SN74AUP1T97YFPR	ACTIVE	DSBGA	YFP	6	3000	RoHS & Green	SNAGCU	Level-1-260C-UNLIM	-40 to 85	(TH2, THN)	Samples
SN74AUP1T97YZPR	ACTIVE	DSBGA	YZP	6	3000	RoHS & Green	SNAGCU	Level-1-260C-UNLIM	-40 to 85	(TH2, THN)	Samples

(1) The marketing status values are defined as follows:

ACTIVE: Product device recommended for new designs.

LIFEBUY: TI has announced that the device will be discontinued, and a lifetime-buy period is in effect.

NRND: Not recommended for new designs. Device is in production to support existing customers, but TI does not recommend using this part in a new design.

PREVIEW: Device has been announced but is not in production. Samples may or may not be available.

OBSOLETE: TI has discontinued the production of the device.

(2) **RoHS:** TI defines "RoHS" to mean semiconductor products that are compliant with the current EU RoHS requirements for all 10 RoHS substances, including the requirement that RoHS substance do not exceed 0.1% by weight in homogeneous materials. Where designed to be soldered at high temperatures, "RoHS" products are suitable for use in specified lead-free processes. TI may reference these types of products as "Pb-Free".

RoHS Exempt: TI defines "RoHS Exempt" to mean products that contain lead but are compliant with EU RoHS pursuant to a specific EU RoHS exemption.

Green: TI defines "Green" to mean the content of Chlorine (Cl) and Bromine (Br) based flame retardants meet JS709B low halogen requirements of <=1000ppm threshold. Antimony trioxide based flame retardants must also meet the <=1000ppm threshold requirement.

(3) MSL, Peak Temp. - The Moisture Sensitivity Level rating according to the JEDEC industry standard classifications, and peak solder temperature.

(4) There may be additional marking, which relates to the logo, the lot trace code information, or the environmental category on the device.

(5) Multiple Device Markings will be inside parentheses. Only one Device Marking contained in parentheses and separated by a "~" will appear on a device. If a line is indented then it is a continuation of the previous line and the two combined represent the entire Device Marking for that device.

⁽⁶⁾ Lead finish/Ball material - Orderable Devices may have multiple material finish options. Finish options are separated by a vertical ruled line. Lead finish/Ball material values may wrap to two lines if the finish value exceeds the maximum column width.

Important Information and Disclaimer: The information provided on this page represents TI's knowledge and belief as of the date that it is provided. TI bases its knowledge and belief on information provided by third parties, and makes no representation or warranty as to the accuracy of such information. Efforts are underway to better integrate information from third parties. TI has taken and continues to take reasonable steps to provide representative and accurate information but may not have conducted destructive testing or chemical analysis on incoming materials and chemicals. TI and TI suppliers consider certain information to be proprietary, and thus CAS numbers and other limited information may not be available for release.

In no event shall TI's liability arising out of such information exceed the total purchase price of the TI part(s) at issue in this document sold by TI to Customer on an annual basis.

TAPE AND REEL INFORMATION



QUADRANT ASSIGNMENTS FOR PIN 1 ORIENTATION IN TAPE



*All dimensions are nominal

Device	Package Type	Package Drawing	Pins	SPQ	Reel Diameter (mm)	Reel Width W1 (mm)	A0 (mm)	B0 (mm)	K0 (mm)	P1 (mm)	W (mm)	Pin1 Quadrant
SN74AUP1T97DBVR	SOT-23	DBV	6	3000	180.0	8.4	3.23	3.17	1.37	4.0	8.0	Q3
SN74AUP1T97DBVT	SOT-23	DBV	6	250	180.0	8.4	3.23	3.17	1.37	4.0	8.0	Q3
SN74AUP1T97DCKR	SC70	DCK	6	3000	180.0	8.4	2.41	2.41	1.2	4.0	8.0	Q3
SN74AUP1T97DRYR	SON	DRY	6	5000	180.0	8.4	1.25	1.6	0.7	4.0	8.0	Q1
SN74AUP1T97DSFR	SON	DSF	6	5000	180.0	8.4	1.16	1.16	0.63	4.0	8.0	Q2
SN74AUP1T97DSFR	SON	DSF	6	5000	180.0	9.5	1.16	1.16	0.63	4.0	8.0	Q2
SN74AUP1T97YFPR	DSBGA	YFP	6	3000	178.0	9.2	0.89	1.29	0.62	4.0	8.0	Q1
SN74AUP1T97YZPR	DSBGA	YZP	6	3000	178.0	9.2	1.02	1.52	0.63	4.0	8.0	Q1

TAPE AND REEL BOX DIMENSIONS



*All dimensions are nominal

Device	Package Type	Package Drawing	Pins	SPQ	Length (mm)	Width (mm)	Height (mm)
SN74AUP1T97DBVR	SOT-23	DBV	6	3000	202.0	201.0	28.0
SN74AUP1T97DBVT	SOT-23	DBV	6	250	202.0	201.0	28.0
SN74AUP1T97DCKR	SC70	DCK	6	3000	202.0	201.0	28.0
SN74AUP1T97DRYR	SON	DRY	6	5000	202.0	201.0	28.0
SN74AUP1T97DSFR	SON	DSF	6	5000	202.0	201.0	28.0
SN74AUP1T97DSFR	SON	DSF	6	5000	184.0	184.0	19.0
SN74AUP1T97YFPR	DSBGA	YFP	6	3000	220.0	220.0	35.0
SN74AUP1T97YZPR	DSBGA	YZP	6	3000	220.0	220.0	35.0

DCK (R-PDSO-G6)

PLASTIC SMALL OUTLINE

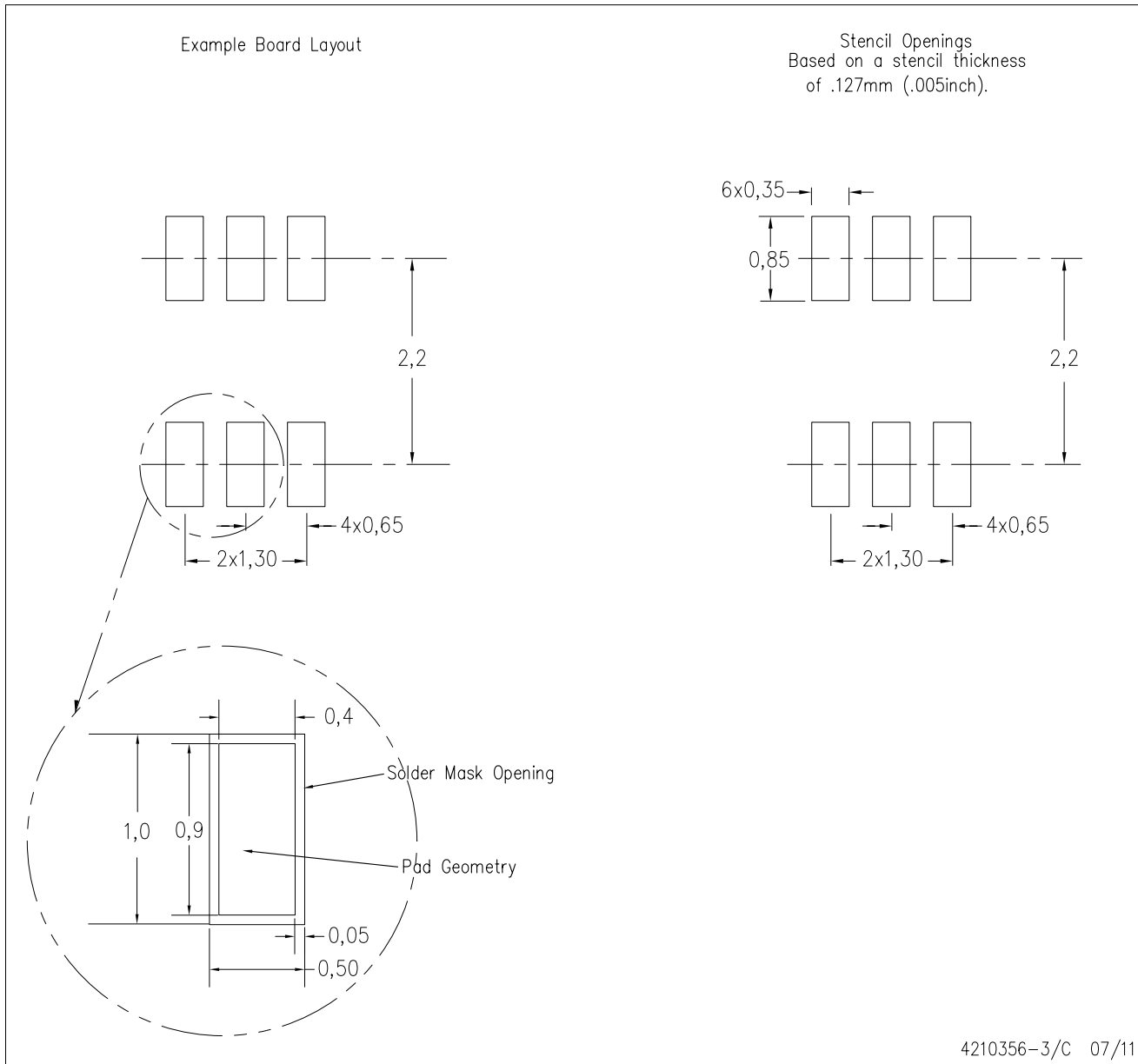

- NOTES:
- All linear dimensions are in millimeters.
 - This drawing is subject to change without notice.
 - Customers should place a note on the circuit board fabrication drawing not to alter the center solder mask defined pad.
 - Publication IPC-7351 is recommended for alternate designs.
 - Laser cutting apertures with trapezoidal walls and also rounding corners will offer better paste release. Customers should contact their board assembly site for stencil design recommendations. Example stencil design based on a 50% volumetric metal load solder paste. Refer to IPC-7525 for other stencil recommendations.

YFP0006

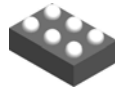

PACKAGE OUTLINE

DSBGA - 0.5 mm max height

DIE SIZE BALL GRID ARRAY

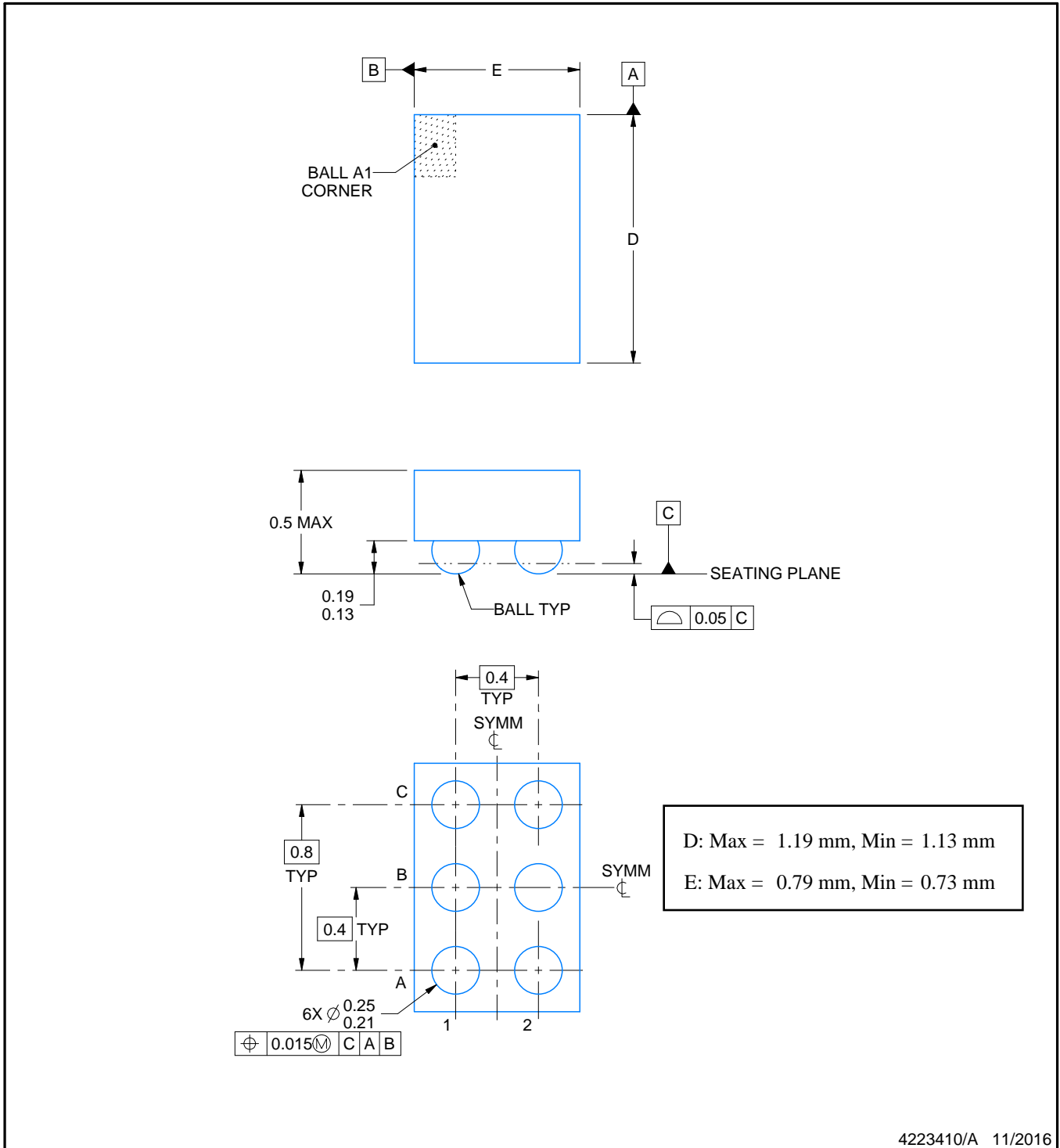

4223410/A 11/2016

NOTES:

1. All linear dimensions are in millimeters. Any dimensions in parenthesis are for reference only. Dimensioning and tolerancing per ASME Y14.5M.
2. This drawing is subject to change without notice.

EXAMPLE BOARD LAYOUT

YFP0006

DSBGA - 0.5 mm max height

DIE SIZE BALL GRID ARRAY

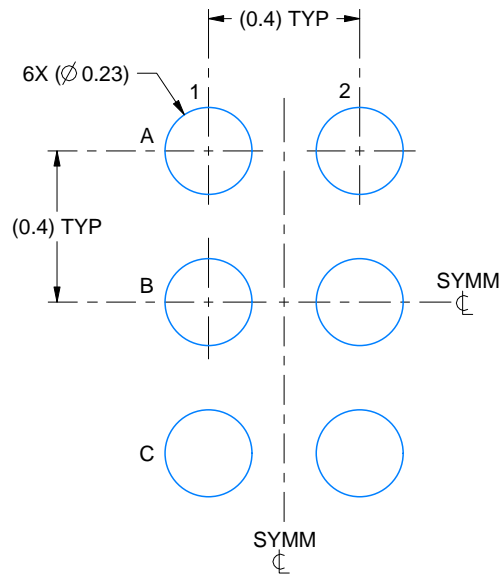

LAND PATTERN EXAMPLE
SCALE:50X

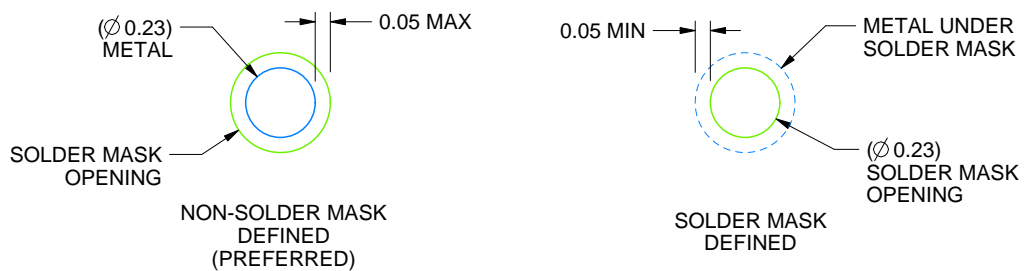

SOLDER MASK DETAILS
NOT TO SCALE

4223410/A 11/2016

NOTES: (continued)

- Final dimensions may vary due to manufacturing tolerance considerations and also routing constraints. For more information, see Texas Instruments literature number SNVA009 (www.ti.com/lit/snva009).

EXAMPLE STENCIL DESIGN

YFP0006

DSBGA - 0.5 mm max height

DIE SIZE BALL GRID ARRAY

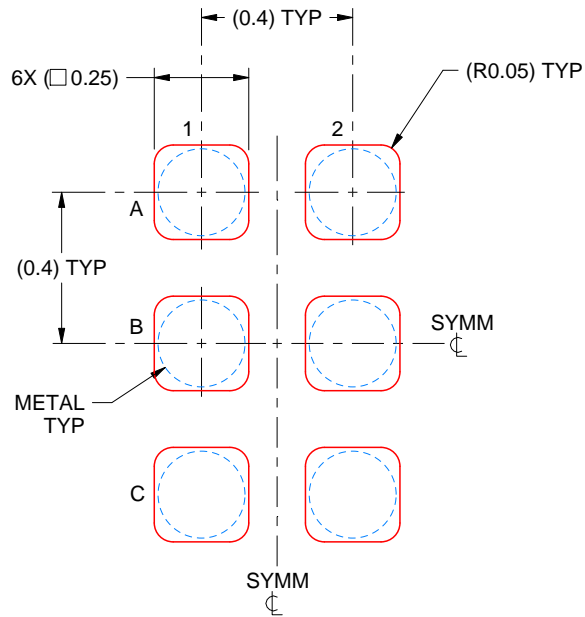

SOLDER PASTE EXAMPLE
BASED ON 0.1 mm THICK STENCIL
SCALE:50X

4223410/A 11/2016

NOTES: (continued)

4. Laser cutting apertures with trapezoidal walls and rounded corners may offer better paste release.

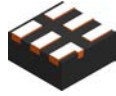

DSF0006A

PACKAGE OUTLINE

X2SON - 0.4 mm max height

PLASTIC SMALL OUTLINE - NO LEAD

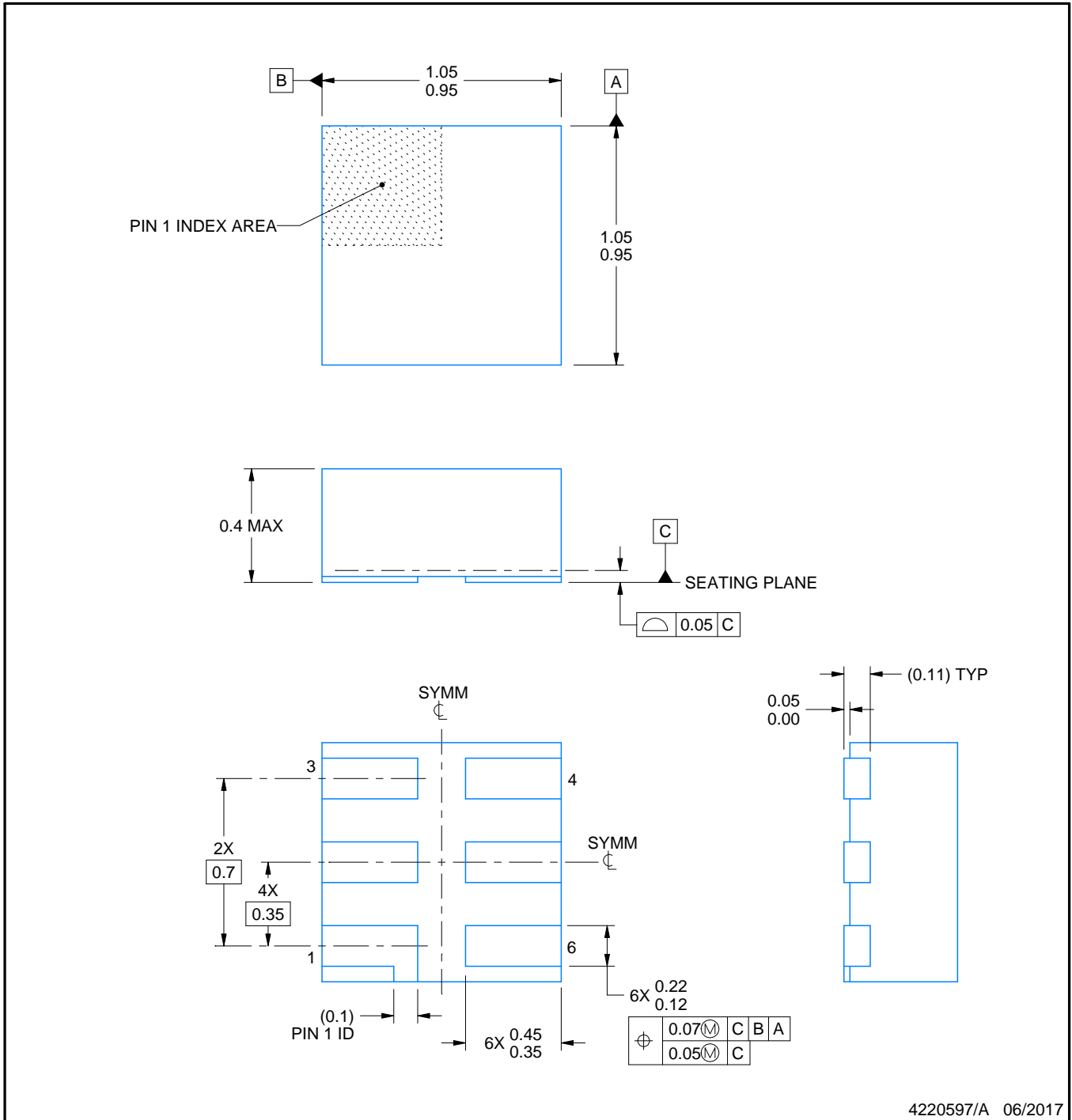

4220597/A 06/2017

NOTES:

1. All linear dimensions are in millimeters. Any dimensions in parenthesis are for reference only. Dimensioning and tolerancing per ASME Y14.5M.
2. This drawing is subject to change without notice.
3. Reference JEDEC registration MO-287, variation X2AAF.

EXAMPLE BOARD LAYOUT

DSF0006A

X2SON - 0.4 mm max height

PLASTIC SMALL OUTLINE - NO LEAD

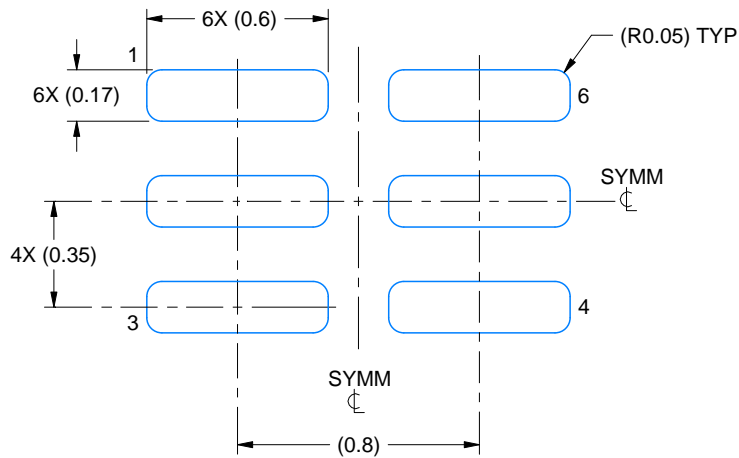

LAND PATTERN EXAMPLE
EXPOSED METAL SHOWN
SCALE:40X

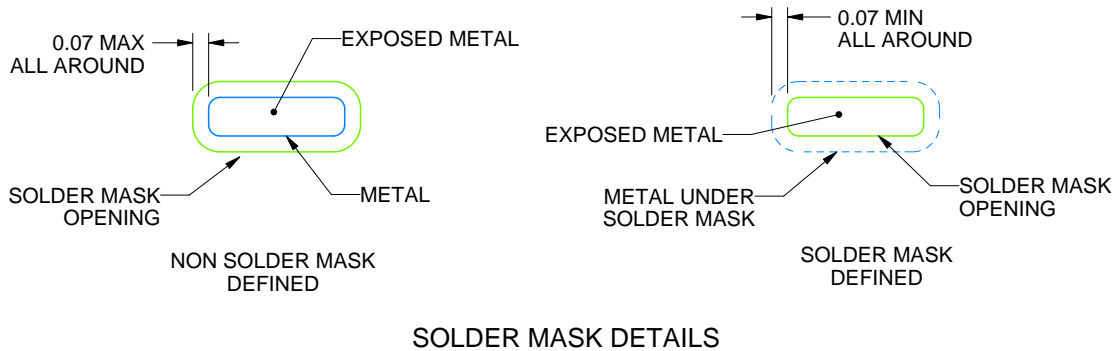

SOLDER MASK DETAILS

4220597/A 06/2017

NOTES: (continued)

4. For more information, see Texas Instruments literature number SLUA271 (www.ti.com/lit/slua271).

EXAMPLE STENCIL DESIGN

DSF0006A

X2SON - 0.4 mm max height

PLASTIC SMALL OUTLINE - NO LEAD

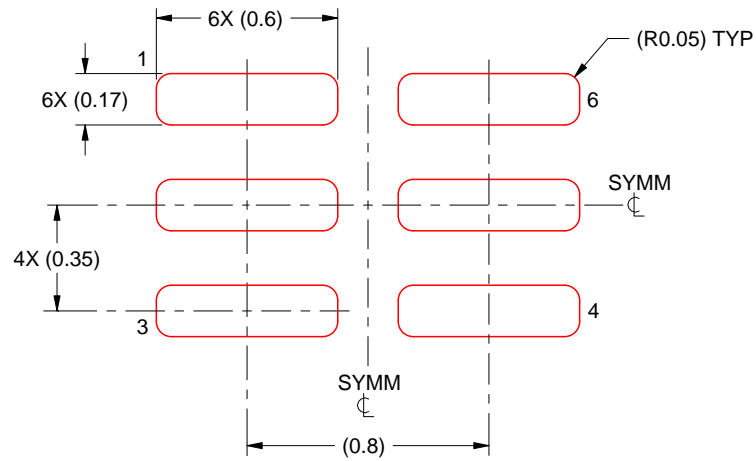

SOLDER PASTE EXAMPLE
BASED ON 0.125 mm THICK STENCIL
PRINTED SOLDER COVERAGE BY AREA UNDER PACKAGE
SCALE:40X

4220597/A 06/2017

4. Laser cutting apertures with trapezoidal walls and rounded corners may offer better paste release. IPC-7525 may have alternate design recommendations.

EXAMPLE BOARD LAYOUT

DBV0006A

SOT-23 - 1.45 mm max height

SMALL OUTLINE TRANSISTOR

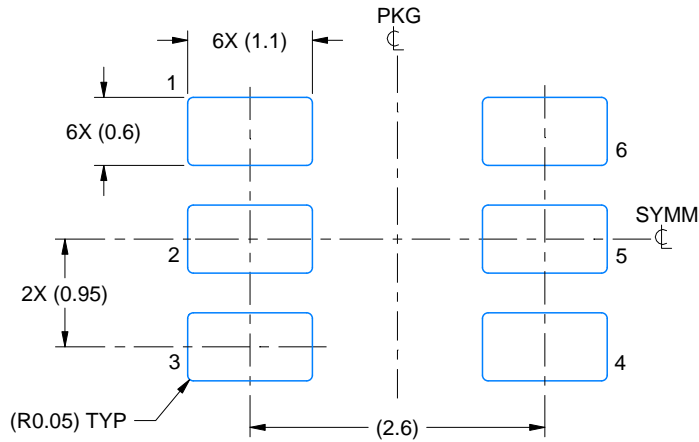

LAND PATTERN EXAMPLE
EXPOSED METAL SHOWN
SCALE:15X

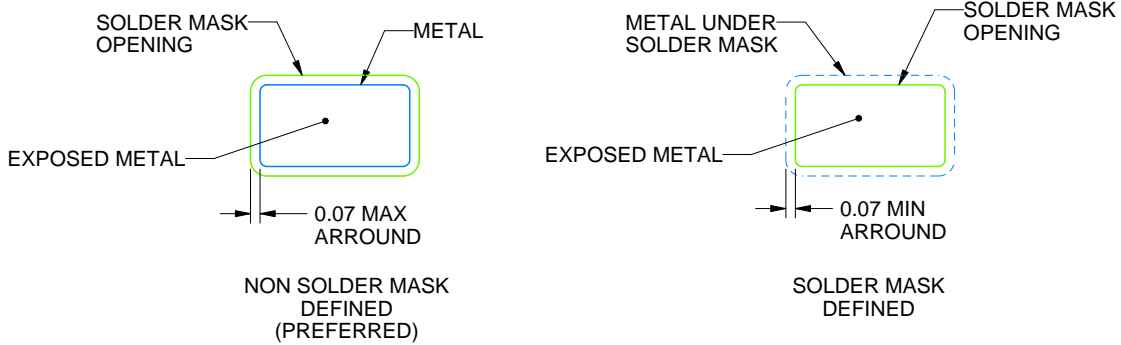

SOLDER MASK DETAILS

4214840/C 06/2021

NOTES: (continued)

- 6. Publication IPC-7351 may have alternate designs.
- 7. Solder mask tolerances between and around signal pads can vary based on board fabrication site.

EXAMPLE STENCIL DESIGN

DBV0006A

SOT-23 - 1.45 mm max height

SMALL OUTLINE TRANSISTOR

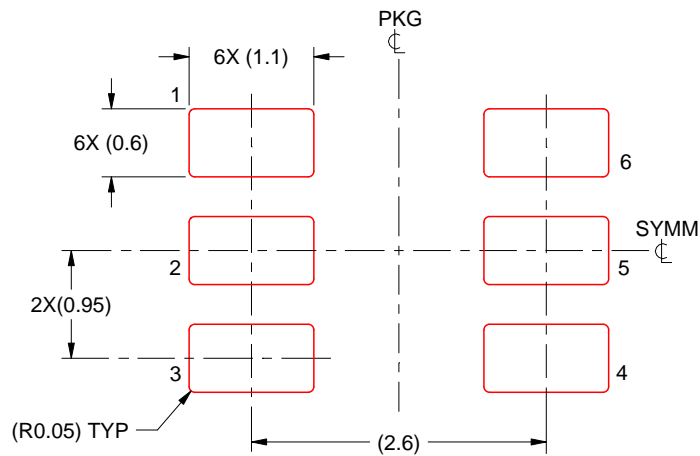

SOLDER PASTE EXAMPLE
BASED ON 0.125 mm THICK STENCIL
SCALE:15X

4214840/C 06/2021

NOTES: (continued)

8. Laser cutting apertures with trapezoidal walls and rounded corners may offer better paste release. IPC-7525 may have alternate design recommendations.
9. Board assembly site may have different recommendations for stencil design.

YZP0006

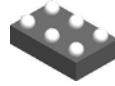

PACKAGE OUTLINE

DSBGA - 0.5 mm max height

DIE SIZE BALL GRID ARRAY

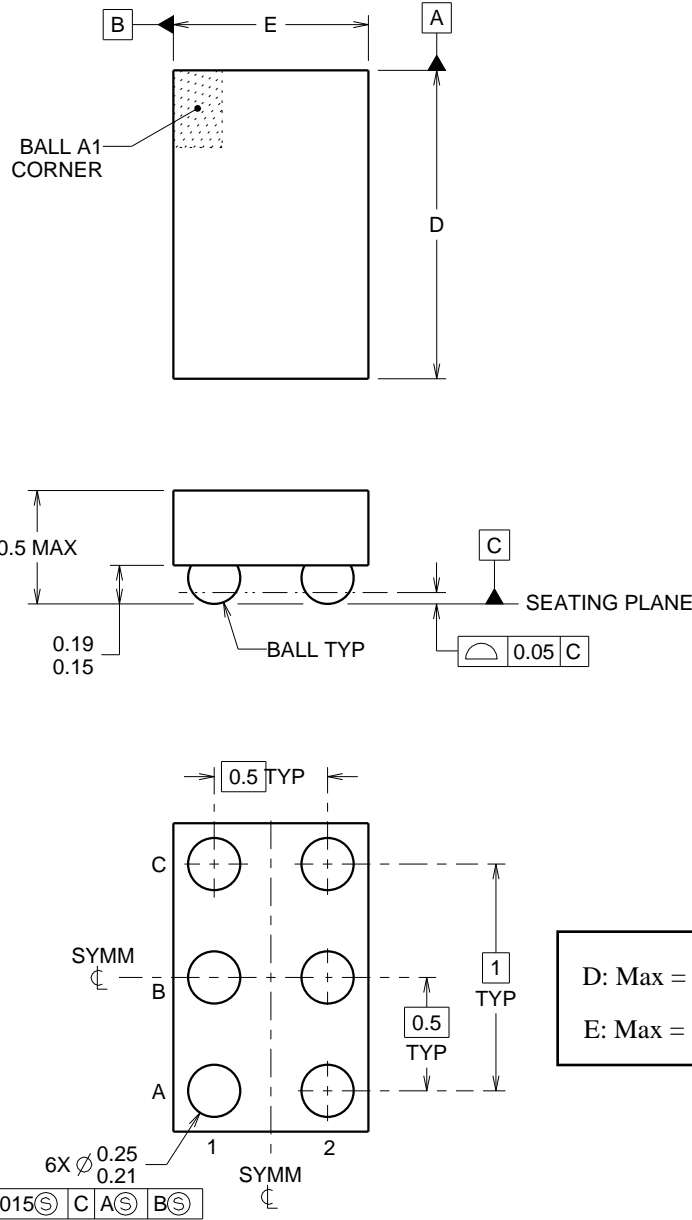

D: Max = 1.418 mm, Min = 1.358 mm
 E: Max = 0.918 mm, Min = 0.858 mm

4219524/A 06/2014

NOTES:

NanoFree Is a trademark of Texas Instruments.

1. All linear dimensions are in millimeters. Any dimensions in parenthesis are for reference only. Dimensioning and tolerancing per ASME Y14.5M.
2. This drawing is subject to change without notice.
3. NanoFree™ package configuration.

EXAMPLE BOARD LAYOUT

YZP0006

DSBGA - 0.5 mm max height

DIE SIZE BALL GRID ARRAY



LAND PATTERN EXAMPLE
SCALE:40X

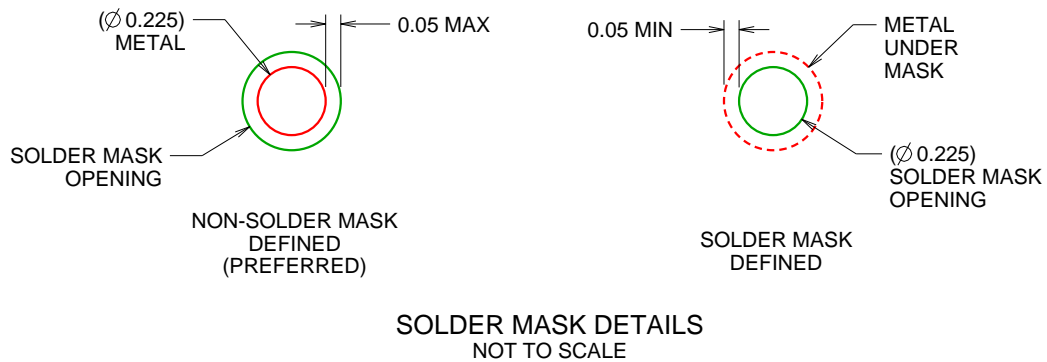

4219524/A 06/2014

NOTES: (continued)

- Final dimensions may vary due to manufacturing tolerance considerations and also routing constraints. For more information, see Texas Instruments literature number SBVA017 (www.ti.com/lit/sbva017).

EXAMPLE STENCIL DESIGN

YZP0006

DSBGA - 0.5 mm max height

DIE SIZE BALL GRID ARRAY

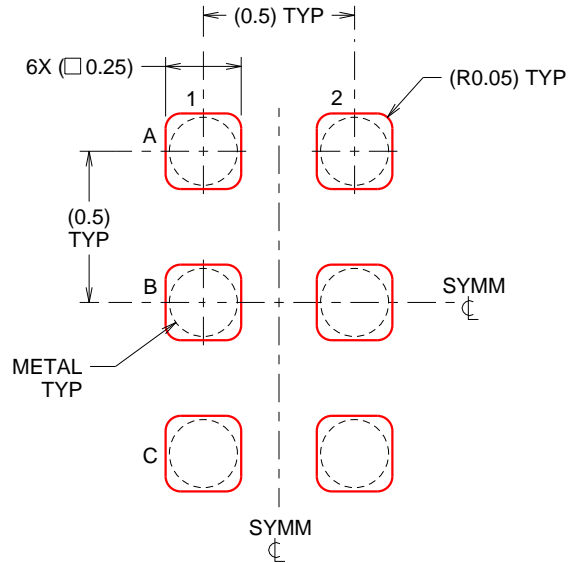

SOLDER PASTE EXAMPLE
BASED ON 0.1 mm THICK STENCIL
SCALE:40X

4219524/A 06/2014

NOTES: (continued)

5. Laser cutting apertures with trapezoidal walls and rounded corners may offer better paste release.

GENERIC PACKAGE VIEW

DRY 6

USON - 0.6 mm max height

PLASTIC SMALL OUTLINE - NO LEAD



Images above are just a representation of the package family, actual package may vary.
Refer to the product data sheet for package details.

4207181/G

EXAMPLE BOARD LAYOUT

DRY0006A

USON - 0.6 mm max height

PLASTIC SMALL OUTLINE - NO LEAD



LAND PATTERN EXAMPLE
1:1 RATIO WITH PKG SOLDER PADS
EXPOSED METAL SHOWN
SCALE:40X



SOLDER MASK DETAILS

4222894/A 01/2018

NOTES: (continued)

3. For more information, see QFN/SON PCB application report in literature No. SLUA271 (www.ti.com/lit/sluea271).

EXAMPLE STENCIL DESIGN

DRY0006A

USON - 0.6 mm max height

PLASTIC SMALL OUTLINE - NO LEAD



SOLDER PASTE EXAMPLE
BASED ON 0.075 - 0.1 mm THICK STENCIL
SCALE:40X

4222894/A 01/2018

NOTES: (continued)

4. Laser cutting apertures with trapezoidal walls and rounded corners may offer better paste release. IPC-7525 may have alternate design recommendations.

重要声明和免责声明

TI“按原样”提供技术和可靠性数据（包括数据表）、设计资源（包括参考设计）、应用或其他设计建议、网络工具、安全信息和其他资源，不保证没有瑕疵且不做任何明示或暗示的担保，包括但不限于对适销性、某特定用途方面的适用性或不侵犯任何第三方知识产权的暗示担保。

这些资源可供使用 TI 产品进行设计的熟练开发人员使用。您将自行承担以下全部责任：(1) 针对您的应用选择合适的 TI 产品，(2) 设计、验证并测试您的应用，(3) 确保您的应用满足相应标准以及任何其他功能安全、信息安全、监管或其他要求。

这些资源如有变更，恕不另行通知。TI 授权您仅可将这些资源用于研发本资源所述的 TI 产品的应用。严禁对这些资源进行其他复制或展示。您无权使用任何其他 TI 知识产权或任何第三方知识产权。您应全额赔偿因在这些资源的使用中对 TI 及其代表造成的任何索赔、损害、成本、损失和债务，TI 对此概不负责。

TI 提供的产品受 [TI 的销售条款](#) 或 [ti.com](#) 上其他适用条款/TI 产品随附的其他适用条款的约束。TI 提供这些资源并不会扩展或以其他方式更改 TI 针对 TI 产品发布的适用的担保或担保免责声明。

TI 反对并拒绝您可能提出的任何其他或不同的条款。

邮寄地址：Texas Instruments, Post Office Box 655303, Dallas, Texas 75265

Copyright © 2022，德州仪器 (TI) 公司