

INA301 带有高速过流比较器的 36V 高速、零漂移、电压输出分流监控器

1 特性

- 宽共模输入范围：0V 至 36V
- 双输出：放大器和比较器输出
- 高精度放大器：
 - 偏移电压：35 μ V（最大值）
 - 偏移电压漂移：0.5 μ V/ $^{\circ}$ C（最大值）
 - 增益误差：0.1%（最大值）
 - 增益误差漂移：10ppm/ $^{\circ}$ C
- 可用放大器增益：
 - INA301A1：20V/V
 - INA301A2：50V/V
 - INA301A3：100V/V
- 可编程的报警阈值，通过单个电阻设置
- 总报警响应时间：1 μ s
- 锁存模式下的开漏输出
- 封装：超薄小外形尺寸封装 (VSSOP)-8

2 应用范围

- 过流保护
- 电源保护
- 断路器
- 计算机和服务服务器
- 电信设备
- 电池管理

3 说明

INA301 由高共模电流感测放大器和高速比较器组成，通过测量电流感测或分流电阻两侧的电压并将该电压与定义的阈值限值作比较来检测过流情况。该器件具有一个可调限制阈值范围，此范围由单个外部限值设定电阻器设置。此分流监控器能够在 0V 至 36V 的共模电压范围内测量差分电压信号，并且与电源电压无关。

开漏报警输出可配置为透明模式（输出状态与输入状态保持一致）或锁存模式（复位锁存时清除报警输出）。器件报警响应时间不到 1 μ s，能够快速检测过流事件。

这款器件由 2.7V-5.5V 单电源供电运行，最大电源电流消耗为 700 μ A。此器件在扩展级温度范围（-40 $^{\circ}$ C 至 +125 $^{\circ}$ C）下额定运行，并采用 8 引脚 VSSOP 封装。

器件信息

器件型号	封装	封装尺寸
INA301	超薄小外形尺寸封装 (VSSOP) (8)	3.00mm \times 3.00mm

典型应用

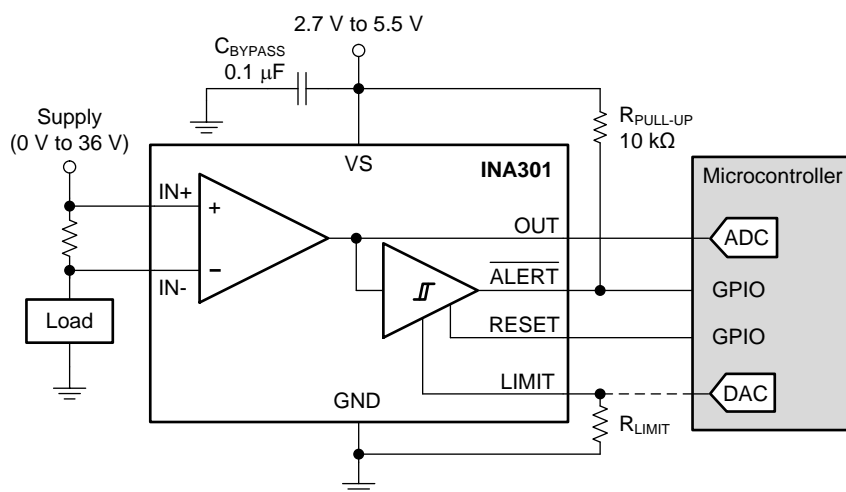

目录

1	特性	1	7.3	Feature Description	14
2	应用范围	1	7.4	Device Functional Modes	19
3	说明	1	8	Applications and Implementation	21
4	修订历史记录	2	8.1	Application Information	21
5	Pin Configuration and Functions	3	8.2	Typical Application	21
6	Specifications	4	9	Power Supply Recommendations	23
6.1	Absolute Maximum Ratings	4	10	Layout	23
6.2	ESD Ratings	4	10.1	Layout Guidelines	23
6.3	Recommended Operating Conditions	4	10.2	Layout Example	23
6.4	Thermal Information	4	11	器件和文档支持	24
6.5	Electrical Characteristics	5	11.1	社区资源	24
6.6	Typical Characteristics	7	11.2	商标	24
7	Detailed Description	13	11.3	静电放电警告	24
7.1	Overview	13	11.4	Glossary	24
7.2	Functional Block Diagram	13	12	机械、封装和可订购信息	24

4 修订历史记录

Changes from Original (September 2015) to Revision A

Page

•	已发布为“量产数据”	1
---	------------------	----------

5 Pin Configuration and Functions

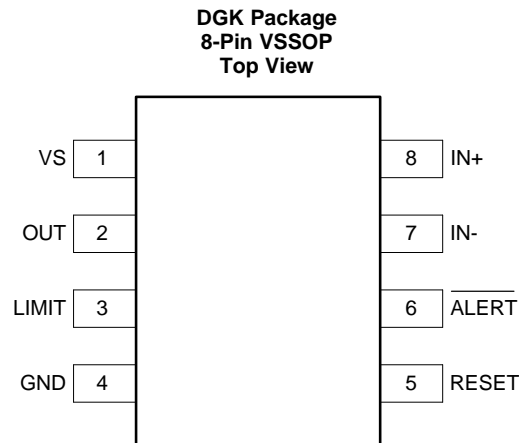

Pin Functions

PIN		I/O	DESCRIPTION
NO.	NAME		
1	VS	Analog	Power supply, 2.7 V to 5.5 V
2	OUT	Analog output	Output voltage
3	LIMIT	Analog input	Alert threshold limit input; see the Setting The Current-Limit Threshold section for details on setting the limit threshold
4	GND	Analog	Ground
5	RESET	Digital input	Transparent or latch mode selection input
6	$\overline{\text{ALERT}}$	Digital output	Overlimit alert, active-low, open-drain output
7	IN-	Analog input	Connect to load side of the shunt resistor
8	IN+	Analog input	Connect to supply side of the shunt resistor

6 Specifications

6.1 Absolute Maximum Ratings

 over operating free-air temperature range (unless otherwise noted)⁽¹⁾

		MIN	MAX	UNIT
Supply voltage, V_S			6	V
Analog inputs (IN+, IN-)	Differential ($V_{IN+} - V_{IN-}$) ⁽²⁾	-40	40	V
	Common-mode ⁽³⁾	GND - 0.3	40	
Analog input	LIMIT pin	GND - 0.3	$(V_S) + 0.3$	V
Analog output	OUT pin	GND - 0.3	$(V_S) + 0.3$	V
Digital input	RESET pin	GND - 0.3	$(V_S) + 0.3$	V
Digital output	$\overline{\text{ALERT}}$ pin	GND - 0.3	6	V
Junction temperature, T_J			150	°C
Storage temperature, T_{stg}		-65	150	°C

- (1) Stresses beyond those listed under *Absolute Maximum Ratings* may cause permanent damage to the device. These are stress ratings only, which do not imply functional operation of the device at these or any other conditions beyond those indicated under *Recommended Operating Conditions*. Exposure to absolute-maximum-rated conditions for extended periods may affect device reliability.
- (2) V_{IN+} and V_{IN-} are the voltages at the IN+ and IN- pins, respectively.
- (3) Input voltage can exceed the voltage shown without causing damage to the device if the current at that pin is limited to 5 mA.

6.2 ESD Ratings

		VALUE	UNIT
$V_{(ESD)}$ Electrostatic discharge	Human-body model (HBM), per ANSI/ESDA/JEDEC JS-001 ⁽¹⁾	±2000	V
	Charged-device model (CDM), per JEDEC specification JESD22-C101 ⁽²⁾	±1000	

- (1) JEDEC document JEP155 states that 500-V HBM allows safe manufacturing with a standard ESD control process.
- (2) JEDEC document JEP157 states that 250-V CDM allows safe manufacturing with a standard ESD control process.

6.3 Recommended Operating Conditions

over operating free-air temperature range (unless otherwise noted)

		MIN	NOM	MAX	UNIT
V_{CM}	Common-mode input voltage		12		V
V_S	Operating supply voltage		5		V
T_A	Operating free-air temperature	-40		125	°C

6.4 Thermal Information

THERMAL METRIC ⁽¹⁾		INA301	UNIT
		DGK (MSOP)	
		8 PINS	
$R_{\theta JA}$	Junction-to-ambient thermal resistance	161.5	°C/W
$R_{\theta JC(top)}$	Junction-to-case (top) thermal resistance	62.3	°C/W
$R_{\theta JB}$	Junction-to-board thermal resistance	81.4	°C/W
Ψ_{JT}	Junction-to-top characterization parameter	6.8	°C/W
Ψ_{JB}	Junction-to-board characterization parameter	80	°C/W
$R_{\theta JC(bot)}$	Junction-to-case (bottom) thermal resistance	N/A	°C/W

- (1) For more information about traditional and new thermal metrics, see the *Semiconductor and IC Package Thermal Metrics* application report, [SPRA953](#).

6.5 Electrical Characteristics

at $T_A = 25^\circ\text{C}$, $V_{\text{SENSE}} = V_{\text{IN}+} - V_{\text{IN}-} = 10\text{ mV}$, $V_S = 5\text{ V}$, $V_{\text{IN}+} = 12\text{ V}$, and $V_{\text{LIMIT}} = 2\text{ V}$ (unless otherwise noted)

PARAMETER		TEST CONDITIONS	MIN	TYP	MAX	UNIT
INPUT						
V_{CM}	Common-mode input voltage range		0		36	V
V_{IN}	Differential input voltage range	$V_{\text{IN}} = V_{\text{IN}+} - V_{\text{IN}-}$, INA301A1	0		250	mV
		$V_{\text{IN}} = V_{\text{IN}+} - V_{\text{IN}-}$, INA301A2	0		100	
		$V_{\text{IN}} = V_{\text{IN}+} - V_{\text{IN}-}$, INA301A3	0		50	
CMR	Common-mode rejection	INA301A1, $V_{\text{IN}+} = 0\text{ V to }36\text{ V}$, $T_A = -40^\circ\text{C to }+125^\circ\text{C}$	100	110		dB
		INA301A2, $V_{\text{IN}+} = 0\text{ V to }36\text{ V}$, $T_A = -40^\circ\text{C to }+125^\circ\text{C}$	106	118		
		INA301A3, $V_{\text{IN}+} = 0\text{ V to }36\text{ V}$, $T_A = -40^\circ\text{C to }+125^\circ\text{C}$	110	120		
V_{OS}	Offset voltage, RTI ⁽¹⁾	INA301A1		± 25	± 125	μV
		INA301A2		± 15	± 50	
		INA301A3		± 10	± 35	
dV_{OS}/dT	Offset voltage drift, RTI ⁽¹⁾	$T_A = -40^\circ\text{C to }+125^\circ\text{C}$		0.1	0.5	$\mu\text{V}/^\circ\text{C}$
PSRR	Power-supply rejection ratio	$V_S = 2.7\text{ V to }5.5\text{ V}$, $V_{\text{IN}+} = 12\text{ V}$, $T_A = -40^\circ\text{C to }+125^\circ\text{C}$		± 0.1	± 10	$\mu\text{V}/\text{V}$
I_B	Input bias current	I_{B+} , I_{B-}		120		μA
I_{OS}	Input offset current	$V_{\text{SENSE}} = 0\text{ mV}$		± 0.1		μA
OUTPUT						
G	Gain	INA301A1		20		V/V
		INA301A2		50		
		INA301A3		100		
Gain error		INA301A1, $V_{\text{OUT}} = 0.5\text{ V to }V_S - 0.5\text{ V}$		$\pm 0.03\%$	$\pm 0.1\%$	
		INA301A2, $V_{\text{OUT}} = 0.5\text{ V to }V_S - 0.5\text{ V}$		$\pm 0.05\%$	$\pm 0.15\%$	
		INA301A3, $V_{\text{OUT}} = 0.5\text{ V to }V_S - 0.5\text{ V}$		$\pm 0.11\%$	$\pm 0.2\%$	
		$T_A = -40^\circ\text{C to }125^\circ\text{C}$		3	10	
	Nonlinearity error	$V_{\text{OUT}} = 0.5\text{ V to }V_S - 0.5\text{ V}$		$\pm 0.01\%$		
	Maximum capacitive load	No sustained oscillation		500		pF
VOLTAGE OUTPUT						
	Swing to V_S power-supply rail	$R_L = 10\text{ k}\Omega$ to GND, $T_A = -40^\circ\text{C to }+125^\circ\text{C}$		$V_S - 0.05$	$V_S - 0.1$	V
	Swing to GND	$R_L = 10\text{ k}\Omega$ to GND, $T_A = -40^\circ\text{C to }+125^\circ\text{C}$		$V_{\text{GND}} + 20$	$V_{\text{GND}} + 30$	mV
FREQUENCY RESPONSE						
BW	Bandwidth	INA301A1		550		kHz
		INA301A2		500		
		INA301A3		450		
SR	Slew rate			4		V/ μs
NOISE, RTI⁽¹⁾						
	Voltage noise density			30		$\text{nV}/\sqrt{\text{Hz}}$

(1) RTI = referred-to-input.

Electrical Characteristics (continued)

 at $T_A = 25^\circ\text{C}$, $V_{\text{SENSE}} = V_{\text{IN}+} - V_{\text{IN}-} = 10\text{ mV}$, $V_S = 5\text{ V}$, $V_{\text{IN}+} = 12\text{ V}$, and $V_{\text{LIMIT}} = 2\text{ V}$ (unless otherwise noted)

PARAMETER		TEST CONDITIONS	MIN	TYP	MAX	UNIT
COMPARATOR						
t_p	Total alert propagation delay	Input overdrive = 1 mV		0.75	1	μs
	Slew-rate-limited t_p	V_{OUT} step = 0.5 V to 4.5 V, $V_{\text{LIMIT}} = 4\text{ V}$		1	1.5	
I_{LIMIT}	Limit threshold output current	$T_A = 25^\circ\text{C}$	79.7	80	80.3	μA
		$T_A = -40^\circ\text{C}$ to $+125^\circ\text{C}$	79.2		80.8	
V_{OS}	Comparator offset voltage	INA301A1		1	3.5	mV
		INA301A2		1	4	
		INA301A3		1.5	4.5	
HYS	Hysteresis	INA301A1		20		mV
		INA301A2		50		
		INA301A3		100		
V_{IH}	High-level input voltage		1.4		6	V
V_{IL}	Low-level input voltage		0		0.4	V
V_{OL}	Alert low-level output voltage	$I_{\text{OL}} = 3\text{ mA}$		70	300	mV
	$\overline{\text{ALERT}}$ pin leakage input current	$V_{\text{OH}} = 3.3\text{ V}$		0.1	1	μA
	Digital leakage input current	$0 \leq V_{\text{IN}} \leq V_S$		1		μA
POWER SUPPLY						
V_S	Operating supply range	$T_A = -40^\circ\text{C}$ to $+125^\circ\text{C}$	2.7		5.5	V
I_Q	Quiescent current	$V_{\text{SENSE}} = 0\text{ mV}$, $T_A = 25^\circ\text{C}$		500	650	μA
		$T_A = -40^\circ\text{C}$ to $+125^\circ\text{C}$			700	
TEMPERATURE RANGE						
	Specified range		-40		125	$^\circ\text{C}$

6.6 Typical Characteristics

at $T_A = 25^\circ\text{C}$, $V_S = 5\text{ V}$, $V_{IN+} = 12\text{ V}$, and alert pullup resistor = $10\text{ k}\Omega$ (unless otherwise noted)

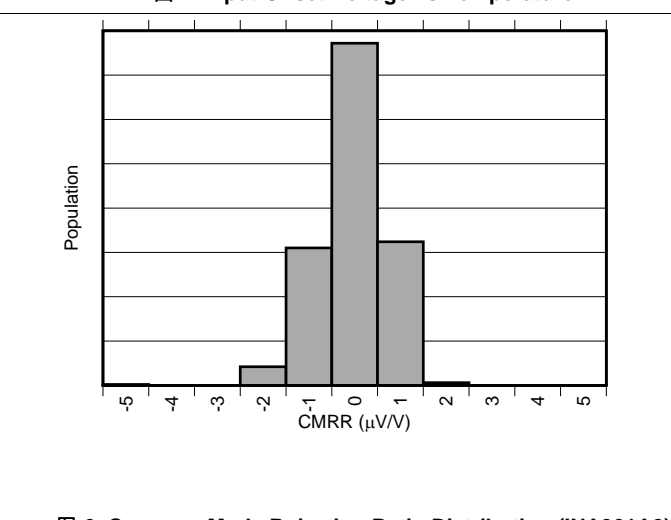
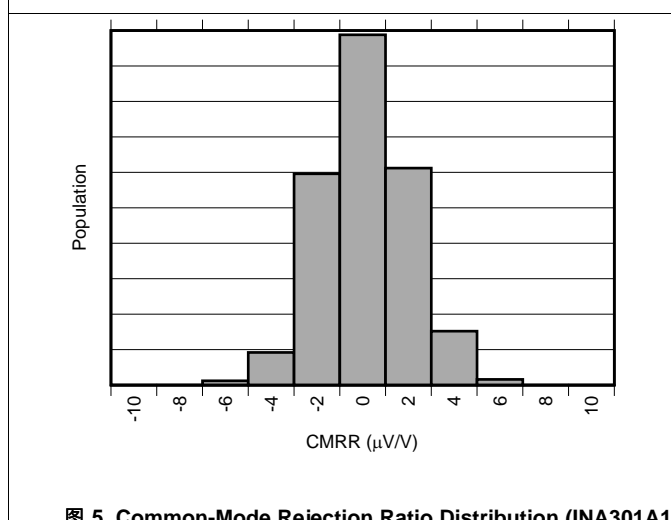
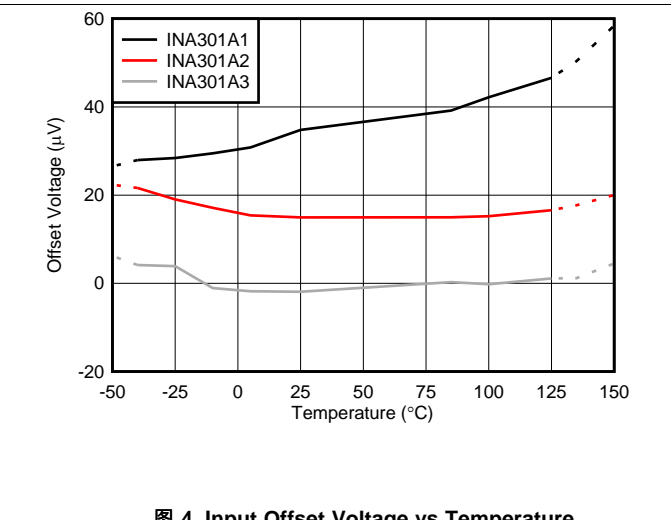
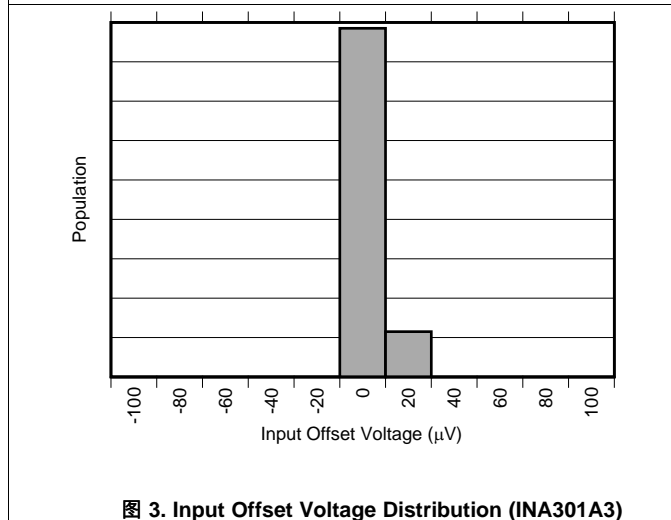
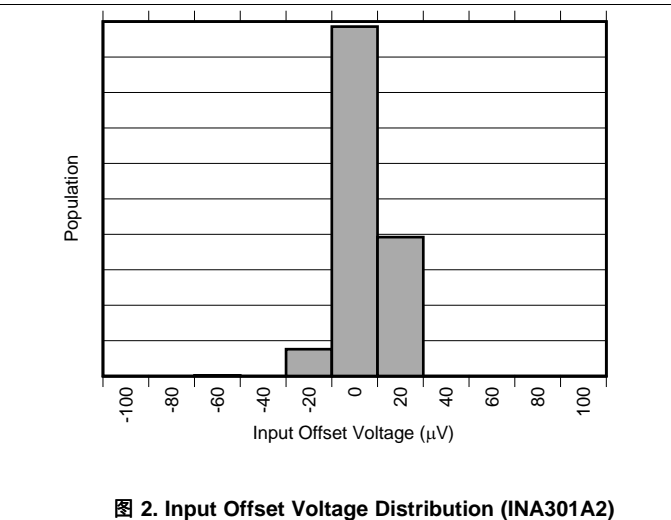
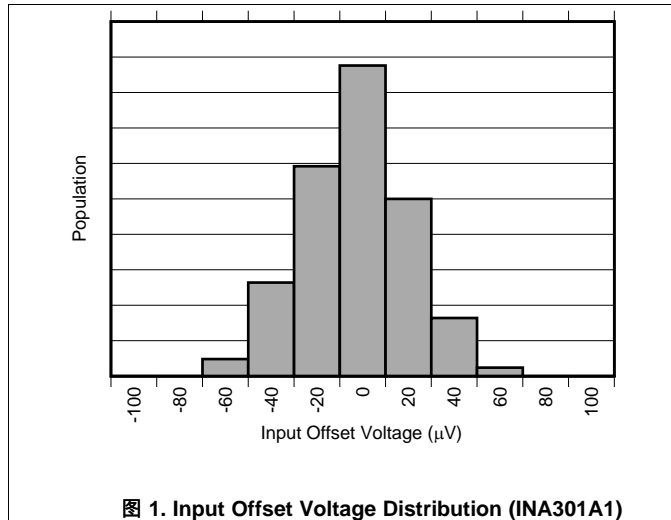

Typical Characteristics (接下页)

at $T_A = 25^\circ\text{C}$, $V_S = 5\text{ V}$, $V_{IN+} = 12\text{ V}$, and alert pullup resistor = $10\text{ k}\Omega$ (unless otherwise noted)

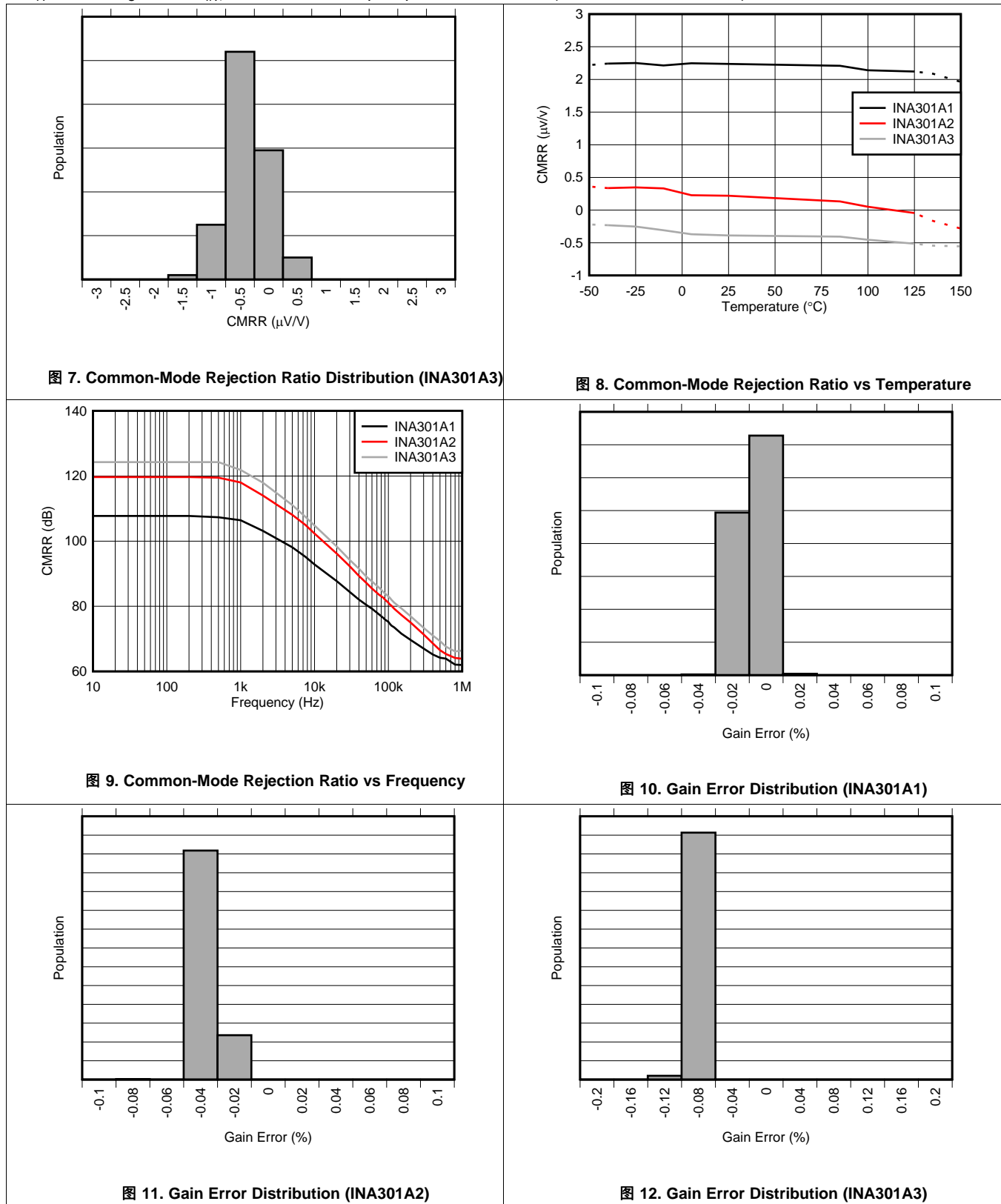

Typical Characteristics (接下页)

at $T_A = 25^\circ\text{C}$, $V_S = 5\text{ V}$, $V_{IN+} = 12\text{ V}$, and alert pullup resistor = $10\text{ k}\Omega$ (unless otherwise noted)



图 13. Gain Error vs Temperature



图 14. Gain vs Frequency

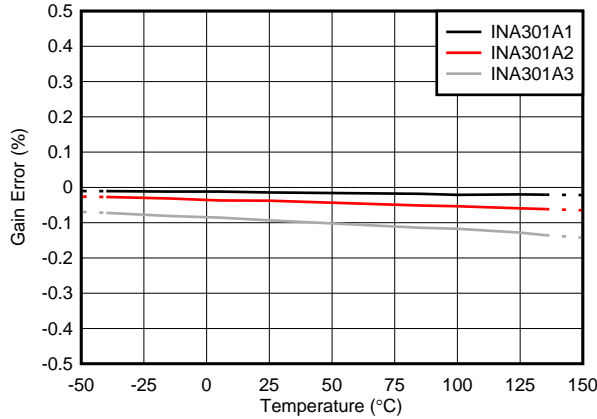

图 15. Power-Supply Rejection Ratio vs Frequency

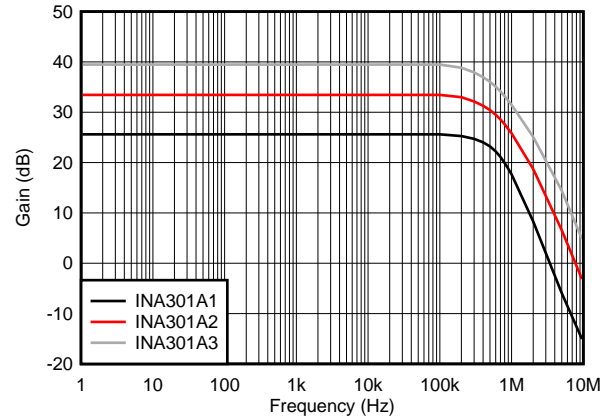

图 16. Output Voltage Swing vs Output Current

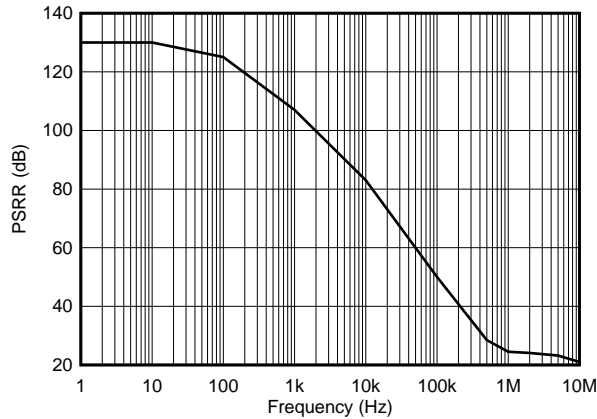

图 17. Input Bias Current vs Common-Mode Voltage ($V_S = 5\text{ V}$)

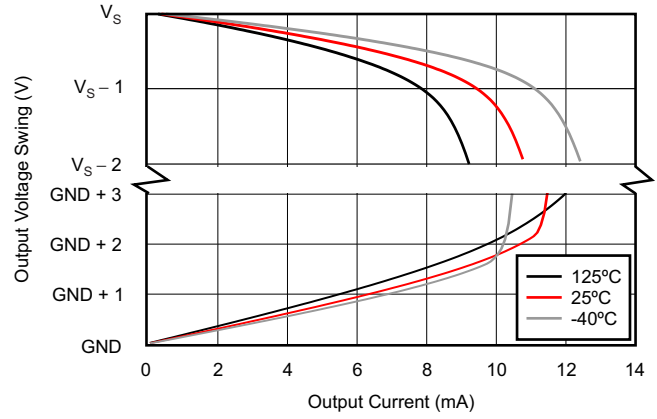

图 18. Input Bias Current vs Common-Mode Voltage ($V_S = 0\text{ V}$)

Typical Characteristics (接下页)

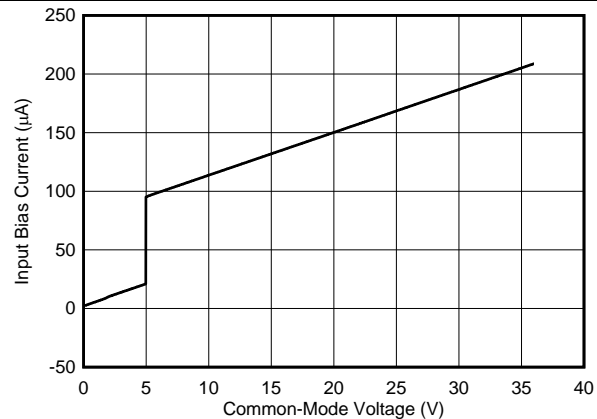
at $T_A = 25^\circ\text{C}$, $V_S = 5\text{ V}$, $V_{IN+} = 12\text{ V}$, and alert pullup resistor = $10\text{ k}\Omega$ (unless otherwise noted)

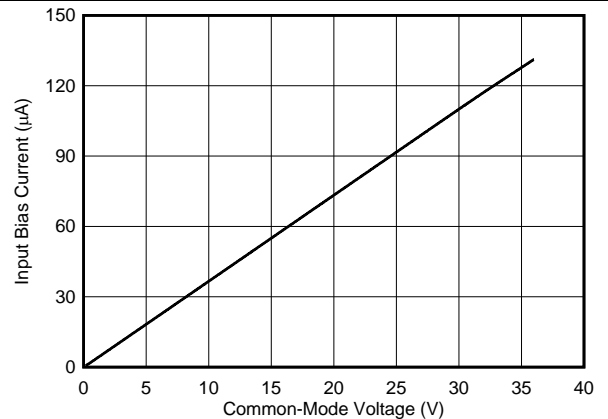

图 19. Input Bias Current vs Temperature



图 20. Quiescent Current vs Supply Voltage

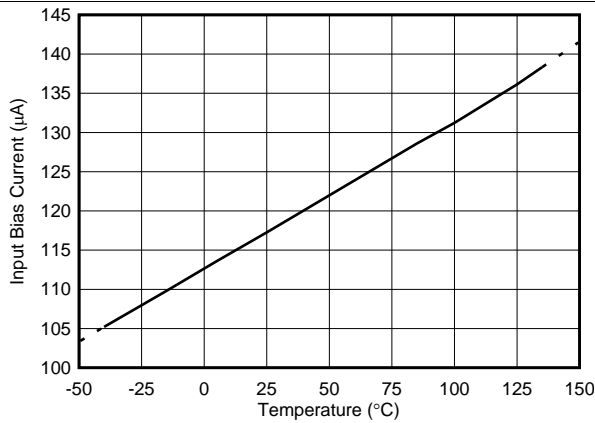

图 21. Quiescent Current vs Temperature

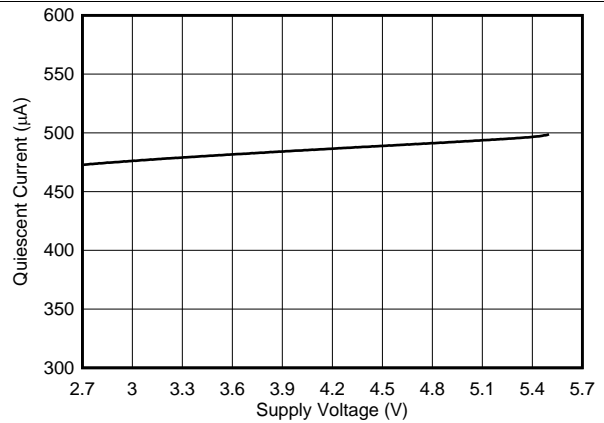

图 22. Input-Referred Voltage Noise vs Frequency

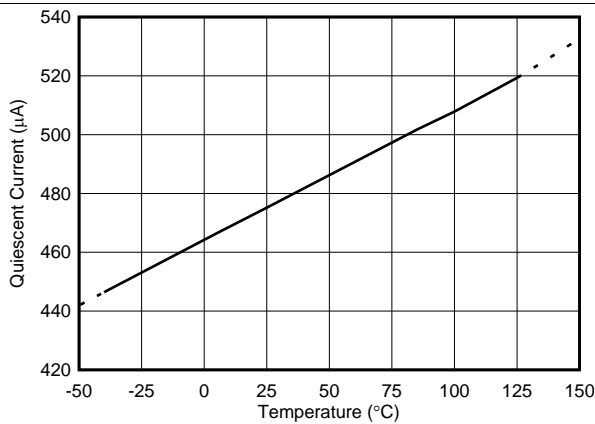

图 23. 0.1-Hz to 10-Hz Voltage Noise (Referred-to-Input)

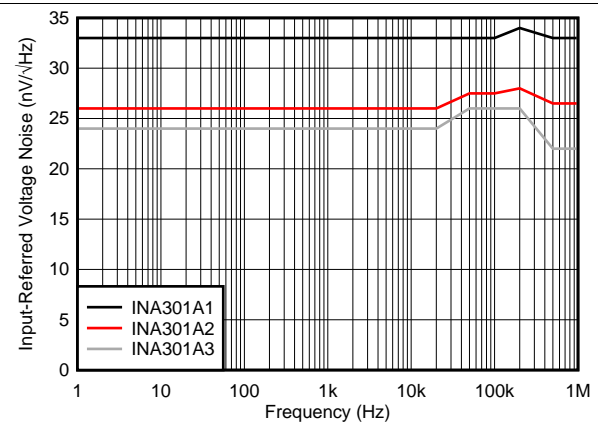

图 24. Voltage Output Rising Step Response (4- V_{PP} Output Step)

Typical Characteristics (接下页)

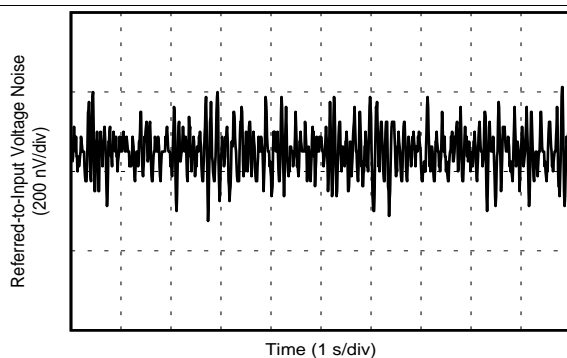
at $T_A = 25^\circ\text{C}$, $V_S = 5\text{ V}$, $V_{IN+} = 12\text{ V}$, and alert pullup resistor = $10\text{ k}\Omega$ (unless otherwise noted)

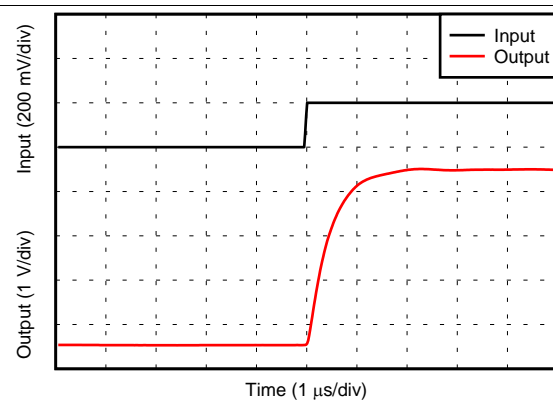
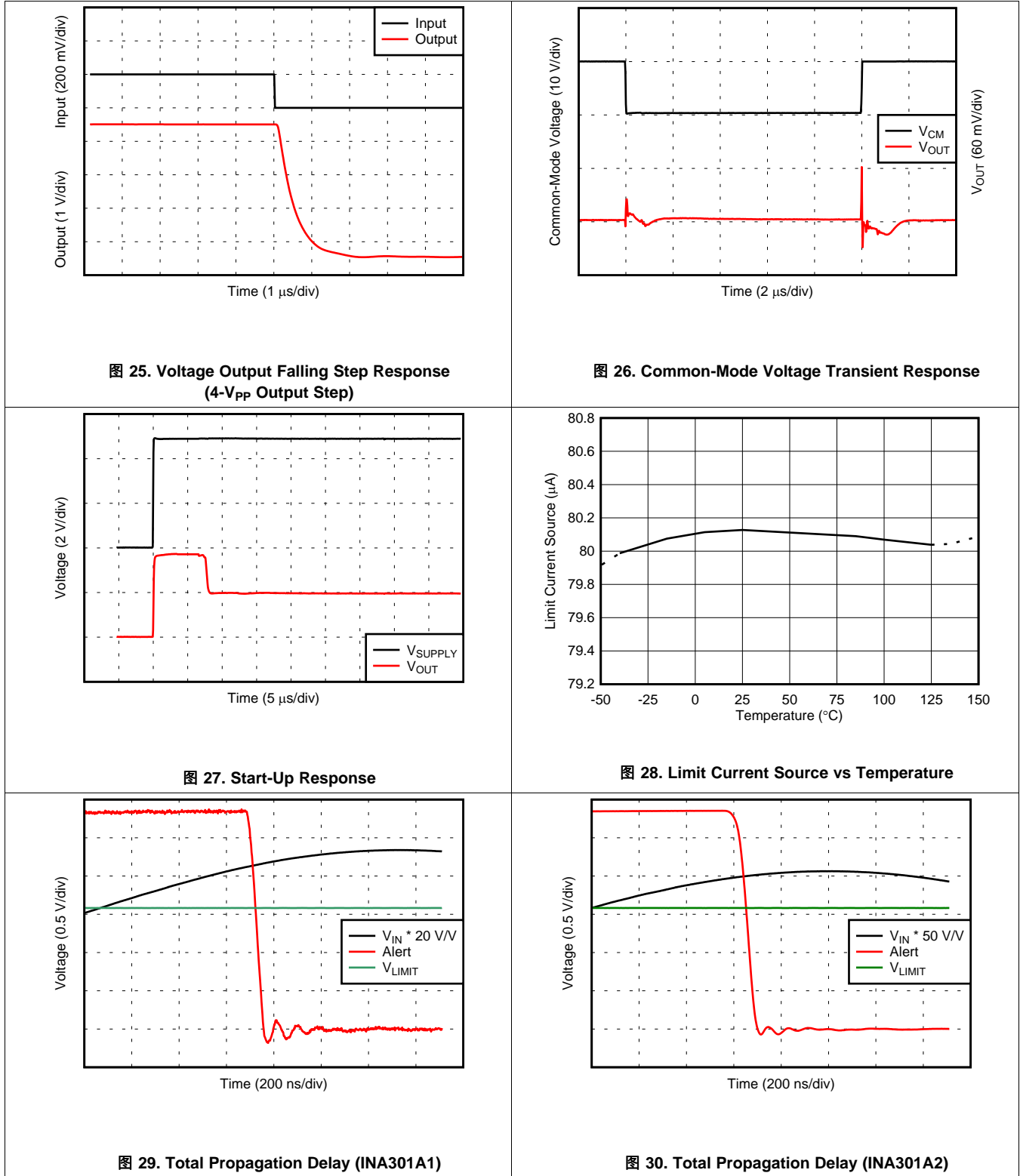

Typical Characteristics (接下页)

at $T_A = 25^\circ\text{C}$, $V_S = 5\text{ V}$, $V_{IN+} = 12\text{ V}$, and alert pullup resistor = $10\text{ k}\Omega$ (unless otherwise noted)



图 31. Total Propagation Delay (INA301A3)



图 32. Comparator Propagation Delay vs Temperature ($V_{OD} = 1\text{ mV}$)

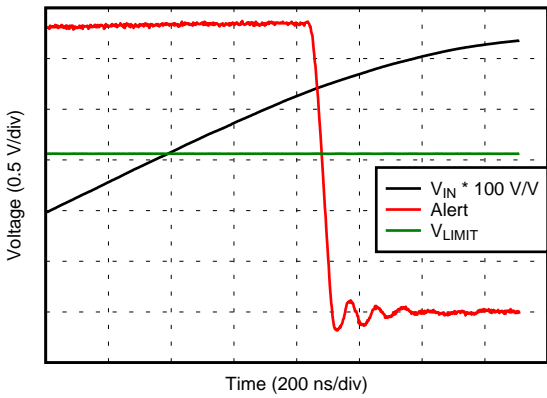

图 33. Comparator Alert V_{OL} vs I_{OL}

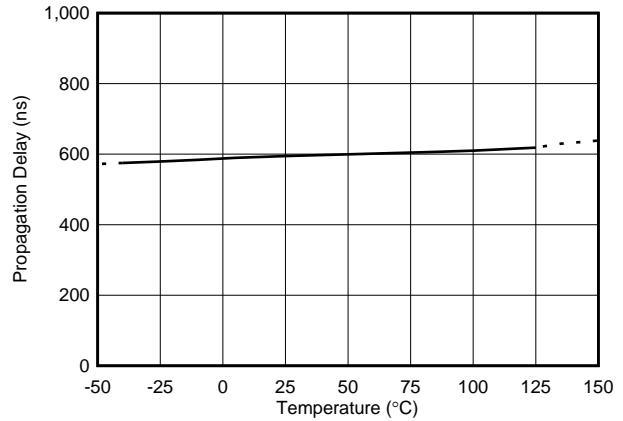

图 34. Hysteresis vs Temperature

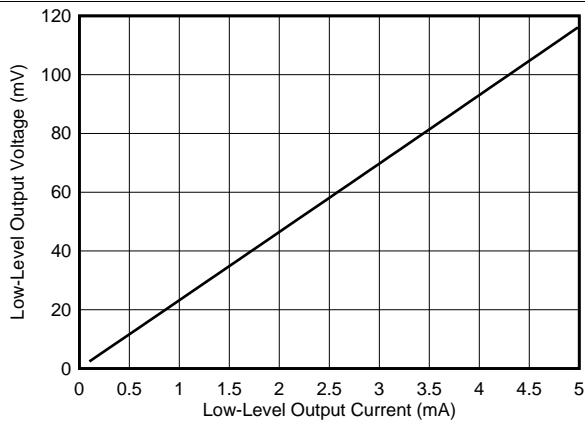

图 35. Comparator Reset Response

7 Detailed Description

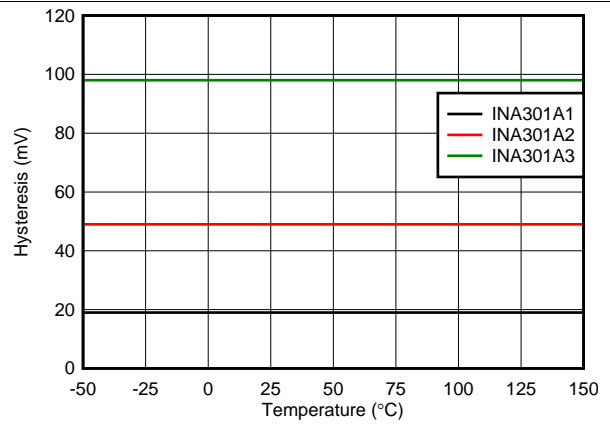
7.1 Overview

The INA301 is a 36-V common-mode, zero-drift topology, current-sensing amplifier that can be used in both low-side and high-side configurations. These specially-designed, current-sensing amplifiers are able to accurately measure voltages developed across current-sensing resistors (also known as current-shunt resistors) on common-mode voltages that far exceed the supply voltage powering the device. Current can be measured on input voltage rails as high as 36 V, and the device can be powered from supply voltages as low as 2.7 V. The device can also withstand the full 36-V common-mode voltage at the input pins when the supply voltage is removed without causing damage.

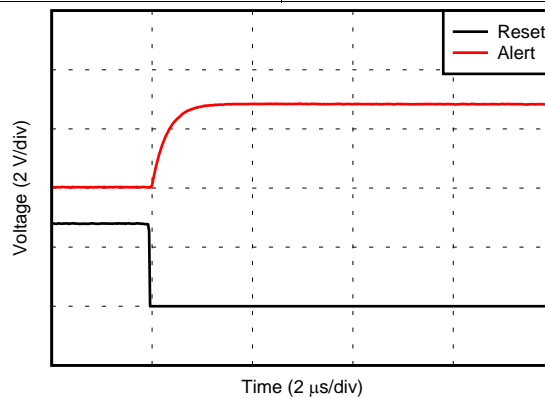
The zero-drift topology enables high-precision measurements with maximum input offset voltages as low as 35 μV with a temperature contribution of only 0.5 $\mu\text{V}/^\circ\text{C}$ over the full temperature range of -40°C to $+125^\circ\text{C}$. The low total offset voltage of the INA301 enables smaller current-sense resistor values to be used, and allows for a more efficient system operation without sacrificing measurement accuracy resulting from the smaller input signal.

The INA301 uses a single external resistor to allow for a simple method of setting the corresponding current threshold level for the device to use for out-of-range comparison. Combining the precision measurement of the current-sense amplifier and the on-board comparator enables an all-in-one overcurrent detection device. This combination creates a highly-accurate solution that is capable of fast detection of out-of-range conditions and allows the system to take corrective actions to prevent potential component or system-wide damage.

7.2 Functional Block Diagram

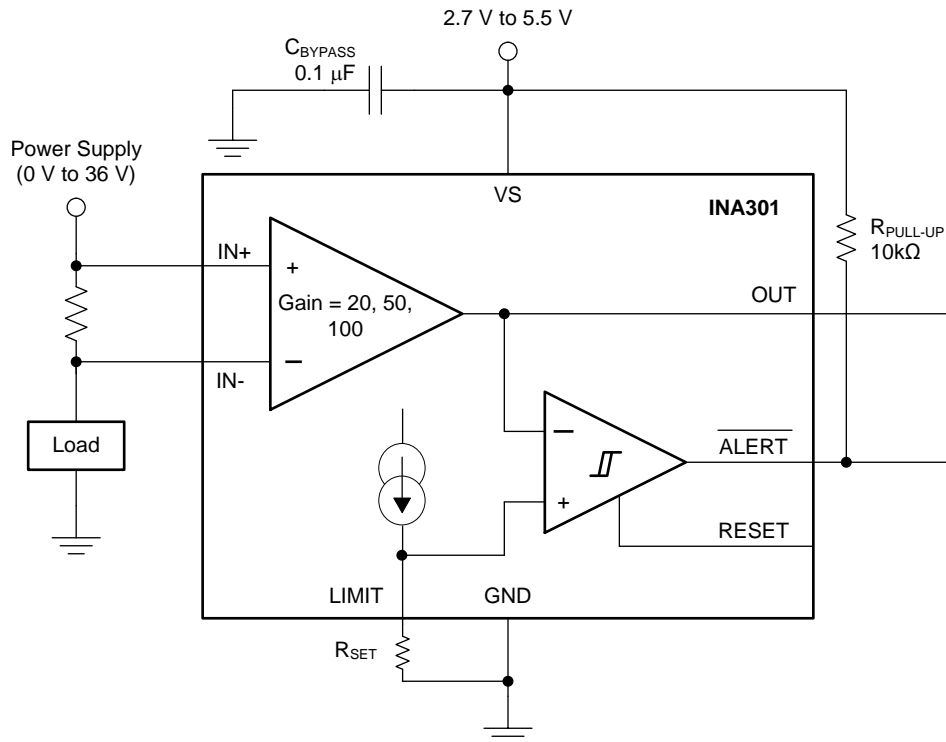

7.3 Feature Description

7.3.1 Alert Output

The device $\overline{\text{ALERT}}$ pin is an active-low, open-drain output that is designed to be pulled low when the input conditions are detected to be out-of-range. This open-drain output pin is recommended to include a 10-k Ω , pullup resistor to the supply voltage. This open-drain pin can be pulled up to a voltage beyond the supply voltage, V_S , but must not exceed 5.5 V.

Figure 36 shows the alert output response of the internal comparator. When the output voltage of the amplifier is lower than the voltage developed at the LIMIT pin, the comparator output is in the default high state. When the amplifier output voltage exceeds the threshold voltage set at the LIMIT pin, the comparator output becomes active and pulls low. This active low output indicates that the measured signal at the amplifier input has exceeded the programmed threshold level, indicating an overcurrent or out-of-range condition has occurred.



图 36. Overcurrent Alert Response

7.3.2 Alert Mode

The device has two output operating modes, transparent and latched, that are selected based on the RESET pin setting. These modes change how the $\overline{\text{ALERT}}$ pin responds following an alert when the overcurrent condition is removed.

7.3.2.1 Transparent Output Mode

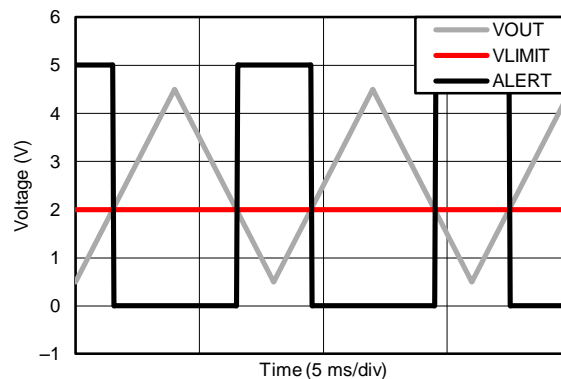
The device is set to transparent mode when the RESET pin is pulled low, thus allowing the output alert state to change and follow the input signal with respect to the programmed alert threshold. For example, when the differential input signal rises above the alert threshold, the alert output pin is pulled low. As soon as the differential input signal drops below the alert threshold, the output returns to the default high output state. A common implementation using the device in transparent mode is to connect the $\overline{\text{ALERT}}$ pin to a hardware interrupt input on a microcontroller. As soon as an overcurrent condition is detected and the $\overline{\text{ALERT}}$ pin is pulled low, the controller interrupt pin detects the output state change and can begin making changes to the system operation required to address the overcurrent condition. Under this configuration, the $\overline{\text{ALERT}}$ pin transition from high to low is captured by the microcontroller so the output can return to the default high state when the overcurrent event is removed.

7.3.2.2 Latch Output Mode

Some applications do not have the functionality available to continuously monitor the state of the output $\overline{\text{ALERT}}$ pin to detect an overcurrent condition as described in the [Transparent Output Mode](#) section. A typical example of this application is a system that is only able to poll the $\overline{\text{ALERT}}$ pin state periodically to determine if the system is functioning correctly. If the device is set to transparent mode in this type of application, the state change of the $\overline{\text{ALERT}}$ pin can be missed when $\overline{\text{ALERT}}$ is pulled low to indicate an out-of-range event if the out-of-range condition does not appear during one of these periodic polling events. Latch mode is specifically intended to accommodate these applications.

Feature Description (接下页)

The device is placed into the corresponding output modes based on the signal connected to RESET, as shown in 表 1. The difference between latch mode and transparent mode is how the alert output responds when an overcurrent event ends. In transparent mode (RESET = low), when the differential input signal drops below the limit threshold level after the $\overline{\text{ALERT}}$ pin asserts because of an overcurrent event, the ALERT pin state returns to the default high setting to indicate that the overcurrent event has ended.

表 1. Output Mode Settings

OUTPUT MODE	RESET PIN SETTING
Transparent mode	RESET = low
Latch mode	RESET = high

In latch mode (RESET = high), when an overlimit condition is detected and the $\overline{\text{ALERT}}$ pin is pulled low, the ALERT pin does not return to the default high state when the differential input signal drops below the alert threshold level. In order to clear the alert, the RESET pin must be pulled low for at least 100 ns. Pulling the RESET pin low allows the $\overline{\text{ALERT}}$ pin to return to the default high level provided that the differential input signal has dropped below the alert threshold. If the input signal is still above the threshold limit when the RESET pin is pulled low, the $\overline{\text{ALERT}}$ pin remains low. When the alert condition is detected by the system controller, the RESET pin can be set back to high in order to place the device back in latch mode.

The latch and transparent modes are represented in 图 37. In 图 37, when V_{IN} drops back below the V_{LIMIT} threshold for the first time, the RESET pin is pulled high. With the RESET pin is pulled high, the device is set to latch mode so that the alert output state does not return high when the input signal drops below the V_{LIMIT} threshold. Only when the RESET pin is pulled low does the $\overline{\text{ALERT}}$ pin return to the default high level, thus indicating that the input signal is below the limit threshold. When the input signal drops below the limit threshold for the second time, the RESET pin is already pulled low. The device is set to transparent mode at this point and the $\overline{\text{ALERT}}$ pin is pulled back high as soon as the input signal drops below the alert threshold.



图 37. Transparent versus Latch Mode

7.3.3 Setting The Current-Limit Threshold

The INA301 determines if an overcurrent event is present by comparing the amplified measured voltage developed across the current-sensing resistor to the corresponding signal developed at the LIMIT pin. The threshold voltage for the LIMIT pin can be set using a single external resistor or by connecting an external voltage source to the LIMIT pin.

7.3.3.1 Resistor-Controlled Current Limit

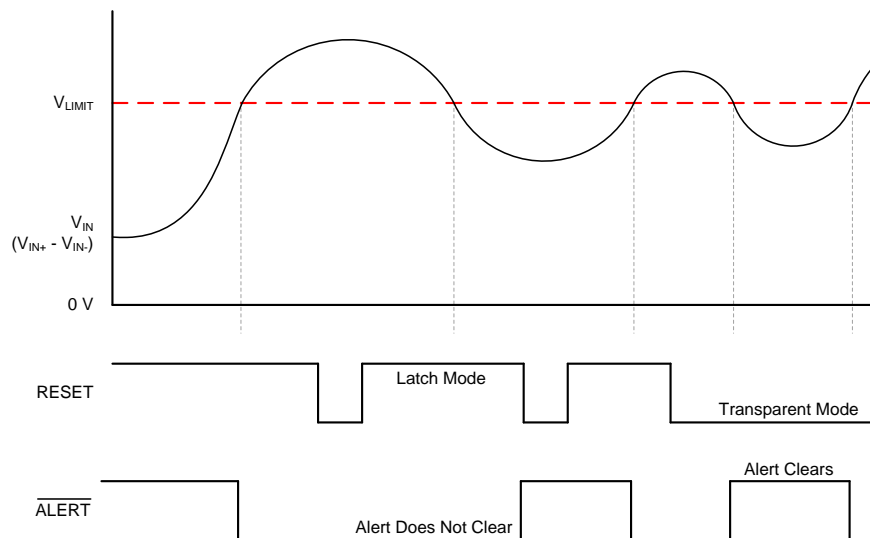
The typical approach for setting the limit threshold voltage is to connect a resistor from the LIMIT pin to ground. The value of this resistor, R_{LIMIT} , is chosen in order to create a corresponding voltage at the LIMIT pin equivalent to the output voltage, V_{OUT} , when the maximum desired load current is flowing through the current-sensing resistor. An internal 80- μ A current source is connected to the LIMIT pin to create a corresponding voltage used to compare to the amplifier output voltage, depending on the value of the R_{LIMIT} resistor.

In the equations from 表 2, V_{TRIP} represents the overcurrent threshold that the device is programmed to monitor for and V_{LIMIT} is the programmed signal set to detect the V_{TRIP} level.

表 2. Calculating the Limit Threshold Setting Resistor, R_{LIMIT}

PARAMETER		EQUATION
V_{TRIP}	V_{OUT} at the desired current trip value	$I_{LOAD} \times R_{SENSE} \times \text{Gain}$
V_{LIMIT}	Threshold limit voltage	$V_{LIMIT} = V_{TRIP}$
		$I_{LIMIT} \times R_{LIMIT}$
R_{LIMIT}	Calculate the threshold limit-setting resistor	V_{LIMIT} / I_{LIMIT}
		$V_{LIMIT} / 80 \mu\text{A}$

7.3.3.1.1 Resistor-Controlled Current Limit: Example

For example, if the current level indicating an out-of-range condition is present is 20 A and the current-sense resistor value is 10 m Ω , then the input threshold signal is 200 mV. The INA301A1 has a gain of 20 so the resulting output voltage at the 20-A input condition is 4 V. The value for R_{LIMIT} is selected to allow the device to detect to this 20-A threshold, indicating an overcurrent event has occurred. When the INA301 detects this out-of-range condition, the $\overline{\text{ALERT}}$ pin asserts and pulls low. For this example, the value of R_{LIMIT} to detect a 4-V level is calculated to be 50 k Ω , as shown in 表 3.

表 3. Calculating the Limit Threshold Setting Resistor, R_{LIMIT} : Example

PARAMETER		EQUATION
V_{TRIP}	V_{OUT} at the desired current trip value	$I_{LOAD} \times R_{SENSE} \times \text{Gain}$
		$20 \text{ A} \times 10 \text{ m}\Omega \times 20 \text{ V/V} = 4 \text{ V}$
V_{LIMIT}	Threshold limit voltage	$V_{LIMIT} = V_{TRIP}$
		$I_{LIMIT} \times R_{LIMIT}$
R_{LIMIT}	Calculate the threshold limit-setting resistor	V_{LIMIT} / I_{LIMIT}
		$4 \text{ V} / 80 \mu\text{A} = 50 \text{ k}\Omega$

7.3.3.2 Voltage-Source-Controlled Current Limit

The second method for setting the limit voltage is to connect the LIMIT pin to a programmable digital-to-analog converter (DAC) or other external voltage source. The benefit of this method is the ability to adjust the current-limit threshold to account for different threshold voltages that are used for different system operating conditions. For example, this method can be used in a system that has one current-limit threshold level that must be monitored during a power-up sequence but different threshold levels that must be monitored during other system operating modes.

In 表 4, V_{TRIP} represents the overcurrent threshold that the device is programmed to monitor for and V_{SOURCE} is the programmed signal set to detect the V_{TRIP} level.

表 4. Calculating the Limit Threshold Voltage Source, V_{SOURCE}

PARAMETER		EQUATION
V_{TRIP}	V_{OUT} at the desired current trip value	$I_{LOAD} \times R_{SENSE} \times \text{Gain}$
V_{SOURCE}	Program the threshold limit voltage	$V_{SOURCE} = V_{TRIP}$

7.3.4 Selecting a Current-Sensing Resistor

The device measures the differential voltage developed across a resistor when current flows through the component to determine if the current being monitored exceeds a defined limit. This resistor is commonly referred to as a *current-sensing resistor* or a *current-shunt resistor*, with each term commonly used interchangeably. The flexible design of the device allows for measuring a wide differential input signal range across this current-sensing resistor.

Selecting the value of this current-sensing resistor is based primarily on two factors: the required accuracy of the current measurement and the allowable power dissipation across the current-sensing resistor. Larger voltages developed across this resistor allow for more accurate measurements to be made. Amplifiers have fixed internal errors that are largely dominated by the inherent input offset voltage. When the input signal decreases, these fixed internal amplifier errors become a larger portion of the measurement and increase the uncertainty in the measurement accuracy. When the input signal increases, the measurement uncertainty is reduced because the fixed errors are a smaller percentage of the signal being measured. Therefore, the use of larger value current-sensing resistors inherently improves the measurement accuracy.

However, a system design trade-off must be evaluated through use of larger input signals for improving the measurement accuracy. Increasing the current sense resistor value results in an increase in power dissipation across the current-sensing resistor. Increasing the value of the current-shunt resistor increases the differential voltage developed across the resistor when current passes through the component. This increase in voltage across the resistor increases the power that the resistor must be able to dissipate. Decreasing the value of the current-shunt resistor value reduces the power dissipation requirements of the resistor, but increases the measurement errors resulting from the decreased input signal. Selecting the optimal value for the shunt resistor requires factoring both the accuracy requirement for the specific application and the allowable power dissipation of this component.

An increasing number of very low ohmic-value resistors are becoming more widely available with values reaching down as low as 200 $\mu\Omega$ or lower with power dissipations of up to 5 W that enable large currents to be accurately monitored with sensing resistors.

7.3.4.1 Selecting a Current-Sensing Resistor: Example

In this example, the trade-offs involved in selecting a current-sensing resistor are discussed. This example requires 2.5% accuracy for detecting a 10-A overcurrent event where only 250 mW is allowable for the dissipation across the current-sensing resistor at the full-scale current level. Although the maximum power dissipation is defined as 250 mW, a lower dissipation is preferred to improve system efficiency. Some initial assumptions are made that are used in this example: the limit-setting resistor (R_{LIMIT}) is a 1% component and the maximum tolerance specification for the internal threshold setting current source (0.5%) is used. Given the total error budget of 2.5%, up to 1% of error is available to be attributed to the measurement error of the device under these conditions.

As shown in 表 5, the maximum value calculated for the current-sensing resistor with these requirements is 2.5 mΩ. Although this value satisfies the maximum power dissipation requirement of 250 mW, headroom is available from the 2.5% maximum total overcurrent detection error to reduce the value of the current-sensing resistor and reduce the power dissipation further. Selecting a 1.5-mΩ, current-sensing resistor value offers a good tradeoff for reducing the power dissipation in this scenario by approximately 40% and still remaining within the accuracy region.

表 5. Calculating the Current-Sensing Resistor, R_{SENSE}

PARAMETER		EQUATION	VALUE	UNIT
I_{MAX}	Maximum current		10	A
P_{D_MAX}	Maximum allowable power dissipation		250	mW
R_{SENSE_MAX}	Maximum allowable R_{SENSE}	P_{D_MAX} / I_{MAX}^2	2.5	mΩ
V_{OS}	Offset voltage		150	μV
V_{OS_ERROR}	Initial offset voltage error	$(V_{OS} / (R_{SENSE_MAX} \times I_{MAX}) \times 100$	0.6%	
E_G	Gain error		0.25%	
$ERROR_{TOTAL}$	Total measurement error	$\sqrt{(V_{OS_ERROR}^2 + E_G^2)}$	0.65%	
	Allowable current threshold accuracy		2.5%	
$ERROR_{INITIAL}$	Initial threshold error	$I_{LIMIT} \text{ Tolerance} + R_{LIMIT} \text{ Tolerance}$	1.5%	
$ERROR_{AVAILABLE}$	Maximum allowable measurement error	Maximum Error – $ERROR_{INITIAL}$	1%	
$V_{OS_ERROR_MAX}$	Maximum allowable offset error	$\sqrt{(ERROR_{AVAILABLE}^2 - E_G^2)}$	0.97%	
V_{DIFF_MIN}	Minimum differential voltage	$V_{OS} / V_{OS_ERROR_MAX} (1\%)$	15	mV
R_{SENSE_MIN}	Minimum sense resistor value	V_{DIFF_MIN} / I_{MAX}	1.5	mΩ
P_{D_MIN}	Lowest possible power dissipation	$R_{SENSE_MIN} \times I_{MAX}^2$	150	mW

7.3.5 Hysteresis

The on-board comparator in the INA301 is designed to reduce the possibility of oscillations in the alert output when the measured signal level is near the overlimit threshold level because of noise. When the output voltage (V_{OUT}) exceeds the voltage developed at the LIMIT pin, the \overline{ALERT} pin is asserted and pulls low. The output voltage must drop below the LIMIT pin threshold voltage by the gain-dependent hysteresis level in order for the \overline{ALERT} pin to de-assert and return to the nominal high state, as shown in 图 38.

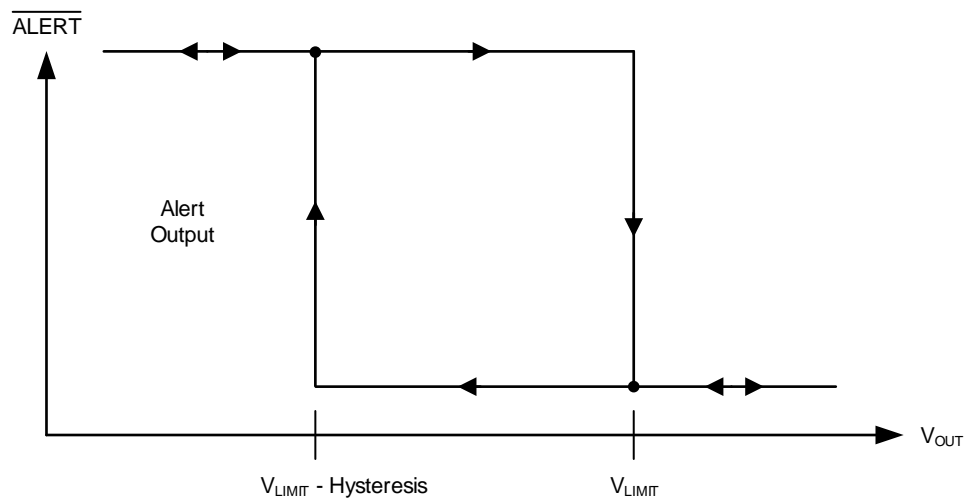
图 38. Typical Comparator Hysteresis

7.4 Device Functional Modes

7.4.1 Input Filtering

External system noise can significantly affect the ability of a comparator to accurately measure and detect whether input signals exceed the reference threshold levels, thus reliably indicating an overrange condition. The most obvious effect that external noise can have on the operation of a comparator is to cause a false alert condition. If a comparator detects a large noise transient coupled into the signal, the device can easily interpret this transient as an overrange condition.

External filtering can help reduce the amount of noise that reaches the comparator and reduce the likelihood of a false alert from occurring. The tradeoff to adding this noise filter is that the alert response time is increased because of the input signal being filtered as well as the noise. 图 39 shows the implementation of an input filter for the device.



图 39. Input Filter

Limiting the amount of input resistance used in this filter is important because this resistance can have a significant affect on the input signal that reaches the device input pins resulting from the device input bias currents. A typical system implementation involves placing the current-sensing resistor very near the device so the traces are very short and the trace impedance is very small. This layout helps reduce the ability of coupling additional noise into the measurement. Under these conditions, the characteristics of the input bias currents have minimal affect on device performance.

As illustrated in 图 40, the input bias currents increase in opposite directions when the differential input voltage increases. This increase results from the design of the device that allows common-mode input voltages to far exceed the device supply voltage range. With input filter resistors now placed in series with these unequal input bias currents, there are unequal voltage drops developed across these input resistors. The difference between these two drops appears as an added signal that (in this case) subtracts from the voltage developed across the current-sensing resistor, thus reducing the signal that reaches the device input pins. Smaller value input resistors reduce this effect of signal attenuation to allow for a more accurate measurement.

Device Functional Modes (接下页)

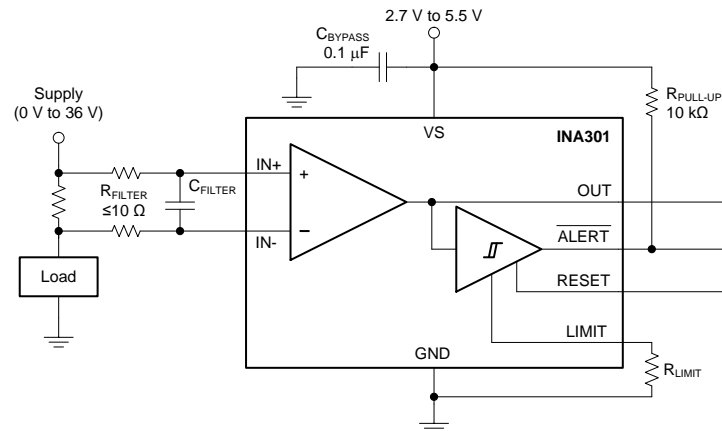

图 40. Input Bias Current vs Differential Input Voltage

For example, with a differential voltage of 10 mV developed across a current-sensing resistor and using 20-Ω resistors, the differential signal that actually reaches the device is 9.85 mV. A measurement error of 1.5% is created as a result of these external input filter resistors. Using 10-Ω input filter resistors instead of the 20-Ω resistors reduces this added error from 1.5% down to 0.75%.

7.4.2 Using The INA301 with Common-Mode Transients Above 36 V

With a small amount of additional circuitry, the device can be used in circuits subject to transients higher than 36 V. Use only zener diodes or zener-type transient absorbers (sometimes referred to as *transzorbs*). Any other type of transient absorber has an unacceptable time delay. Start by adding a pair of resistors, as shown in 图 41, as a working impedance for the zener diode. Keeping these resistors as small as possible is best, preferably 10 Ω or less. Larger values can be used with an additional induced error resulting from a reduced signal that actually reaches the device input pins. Because this circuit limits only short-term transients, many applications are satisfied with a 10-Ω resistor along with conventional zener diodes of the lowest power rating available. This combination uses the least amount of board space. These diodes can be found in packages as small as SOT-523 or SOD-523.

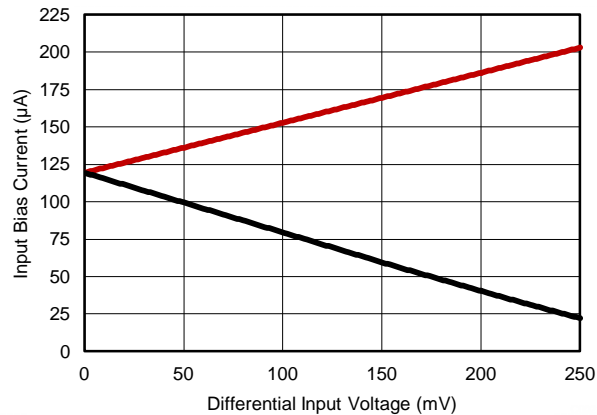

图 41. Transient Protection

8 Applications and Implementation

注

Information in the following applications sections is not part of the TI component specification, and TI does not warrant its accuracy or completeness. TI's customers are responsible for determining suitability of components for their purposes. Customers should validate and test their design implementation to confirm system functionality.

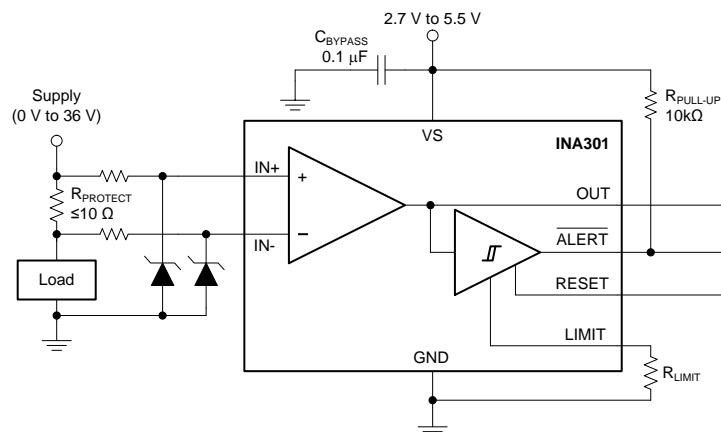
8.1 Application Information

The INA301 is designed to enable easy configuration for detecting overcurrent conditions in an application. This device is individually targeted towards unidirectional overcurrent detection of a single threshold. However, this device can also be paired with additional devices and circuitry to create more complex monitoring functional blocks.

8.2 Typical Application



图 42. Bidirectional Application

8.2.1 Design Requirements

Although the device is only able to measure current through a current-sensing resistor flowing in one direction, a second INA301 can be used to create a bidirectional monitor.

Typical Application (接下页)

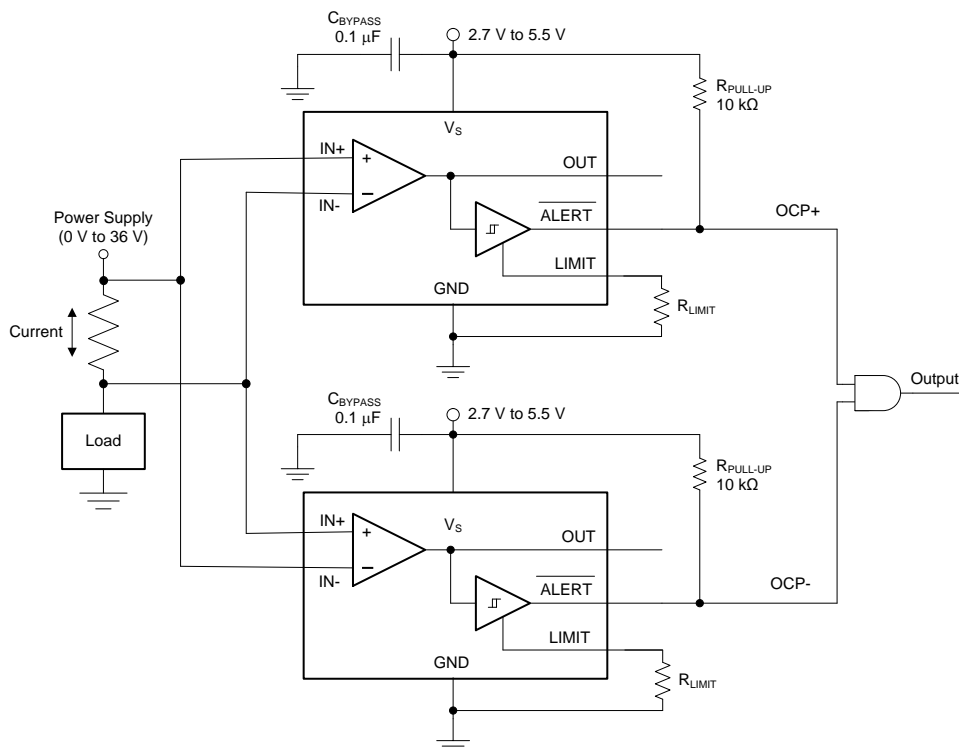
8.2.2 Detailed Design Procedure

With the input pins of a second device reversed across the same current-sensing resistor, the second device is now able to detect current flowing in the other direction relative to the first device; see 图 42. The outputs of each device connect to an AND gate to detect if either of the limit threshold levels are exceeded. As shown in 表 6, the output of the AND gate is high if neither overcurrent limit thresholds are exceeded. A low output state of the AND gate indicates that either the positive overcurrent limit or the negative overcurrent limit are surpassed.

表 6. Bidirectional Overcurrent Output Status

OCP STATUS	OUTPUT
OCP+	0
OCP-	0
No OCP	1

8.2.3 Application Curve

图 43 shows two INA301 devices being used in a bidirectional configuration and an output control circuit to detect if one of the two alerts is exceeded.



图 43. Bidirectional Application Curve

9 Power Supply Recommendations

The device input circuitry can accurately measure signals on common-mode voltages beyond the power-supply voltage, V_S . For example, the voltage applied to the V_S power-supply pin can be 5 V, whereas the load power-supply voltage being monitored (V_{CM}) can be as high as 36 V. Note also that the device can withstand the full -0.3 V to 36 V range at the input pins, regardless of whether the device has power applied or not.

Power-supply bypass capacitors are required for stability and must be placed as closely as possible to the supply and ground pins of the device. A typical value for this supply bypass capacitor is 0.1 μ F. Applications with noisy or high-impedance power supplies can require additional decoupling capacitors to reject power-supply noise.

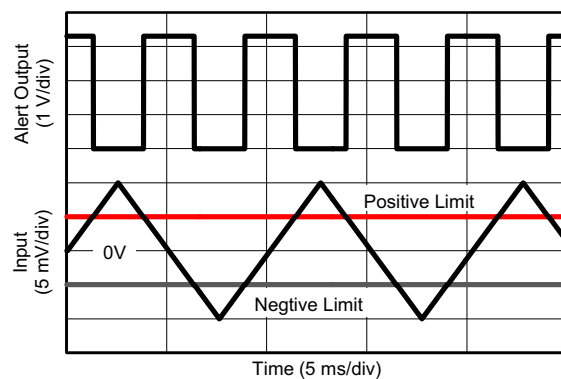
10 Layout

10.1 Layout Guidelines

- Place the power-supply bypass capacitor as closely as possible to the supply and ground pins. The recommended value of this bypass capacitor is 0.1 μ F. Additional decoupling capacitance can be added to compensate for noisy or high-impedance power supplies.
- Make the connection of R_{LIMIT} to the ground pin as direct as possible to limit additional capacitance on this node. Routing this connection must be limited to the same plane if possible to avoid vias to internal planes. If the routing can not be made on the same plane and must pass through vias, ensure that a path is routed from R_{LIMIT} back to the ground pin and that R_{LIMIT} is not simply connected directly to a ground plane.
- The open-drain output pin is recommended to be pulled up to the supply voltage rail through a 10-k Ω pullup resistor.

10.2 Layout Example

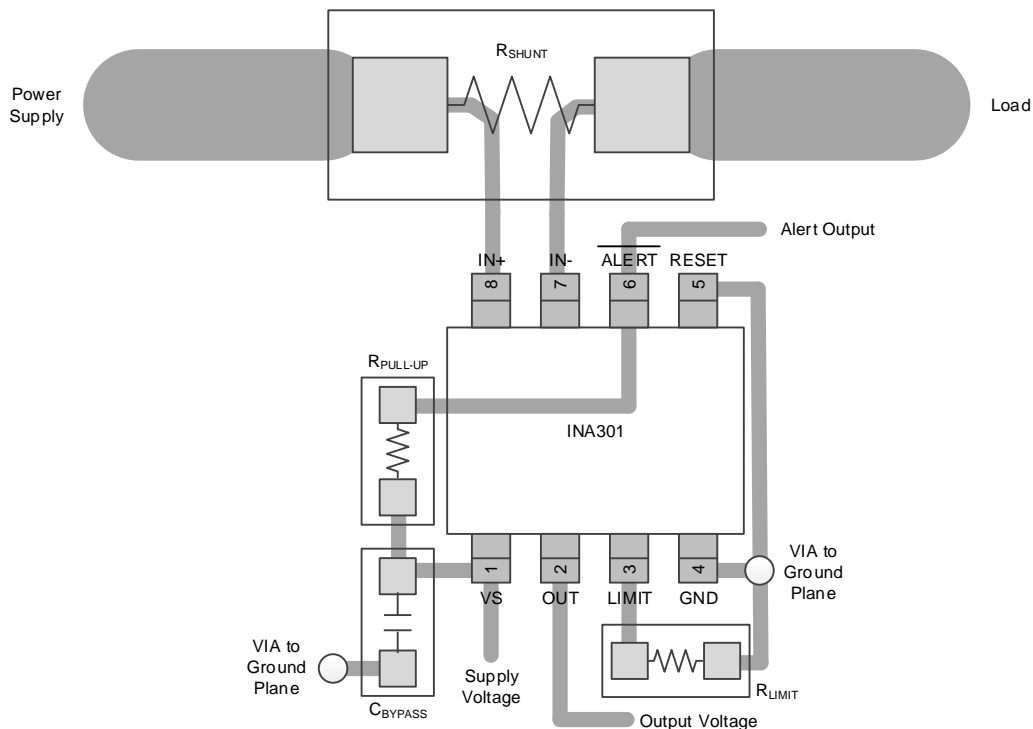

NOTE: Connect the limit resistor directly to the GND pin.

图 44. Recommended Layout

11 器件和文档支持

11.1 社区资源

The following links connect to TI community resources. Linked contents are provided "AS IS" by the respective contributors. They do not constitute TI specifications and do not necessarily reflect TI's views; see TI's [Terms of Use](#).

TI E2E™ Online Community *TI's Engineer-to-Engineer (E2E) Community*. Created to foster collaboration among engineers. At e2e.ti.com, you can ask questions, share knowledge, explore ideas and help solve problems with fellow engineers.

Design Support *TI's Design Support* Quickly find helpful E2E forums along with design support tools and contact information for technical support.

11.2 商标

E2E is a trademark of Texas Instruments.
All other trademarks are the property of their respective owners.

11.3 静电放电警告



这些装置包含有限的内置 ESD 保护。存储或装卸时，应将导线一起截短或将装置放置于导电泡棉中，以防止 MOS 门极遭受静电损伤。

11.4 Glossary

[SLYZ022](#) — *TI Glossary*.

This glossary lists and explains terms, acronyms, and definitions.

12 机械、封装和可订购信息

以下页中包括机械封装和可订购信息。这些信息是针对指定器件可提供的最新数据。这些数据会在无通知且不对本档进行修订的情况下发生改变。要获得这份数据表的浏览器版本，请查阅左侧的导航栏。

重要声明

德州仪器(TI)及其下属子公司有权根据 JESD46 最新标准,对所提供的产品和服务进行更正、修改、增强、改进或其它更改,并有权根据 JESD48 最新标准中止提供任何产品和服务。客户在下订单前应获取最新的相关信息,并验证这些信息是否完整且是最新的。所有产品的销售都遵循在订单确认时所提供的TI 销售条款与条件。

TI 保证其所销售的组件的性能符合产品销售时 TI 半导体产品销售条件与条款的适用规范。仅在 TI 保证的范围内,且 TI 认为有必要时才会使用测试或其它质量控制技术。除非适用法律做出了硬性规定,否则没有必要对每种组件的所有参数进行测试。

TI 对应用帮助或客户产品设计不承担任何义务。客户应对其使用 TI 组件的产品和应用自行负责。为尽量减小与客户产品和应用相关的风险,客户应提供充分的设计与操作安全措施。

TI 不对任何 TI 专利权、版权、屏蔽作品权或其它与使用了 TI 组件或服务的组合设备、机器或流程相关的 TI 知识产权中授予的直接或隐含权限作出任何保证或解释。TI 所发布的与第三方产品或服务有关的信息,不能构成从 TI 获得使用这些产品或服务的许可、授权、或认可。使用此类信息可能需要获得第三方的专利权或其它知识产权方面的许可,或是 TI 的专利权或其它知识产权方面的许可。

对于 TI 的产品手册或数据表中 TI 信息的重要部分,仅在没有对内容进行任何篡改且带有相关授权、条件、限制和声明的情况下才允许进行复制。TI 对此类篡改过的文件不承担任何责任或义务。复制第三方的信息可能需要服从额外的限制条件。

在转售 TI 组件或服务时,如果对该组件或服务参数的陈述与 TI 标明的参数相比存在差异或虚假成分,则会失去相关 TI 组件或服务的所有明示或暗示授权,且这是不正当的、欺诈性商业行为。TI 对任何此类虚假陈述均不承担任何责任或义务。

客户认可并同意,尽管任何应用相关信息或支持仍可能由 TI 提供,但他们将独立负责满足与其产品及其在应用中使用的 TI 产品相关的所有法律、法规和安全相关要求。客户声明并同意,他们具备制定与实施安全措施所需的全部专业技术和知识,可预见故障的危险后果、监测故障及其后果、降低有可能造成人身伤害的故障的发生机率并采取适当的补救措施。客户将全额赔偿因在此类安全关键应用中使用任何 TI 组件而对 TI 及其代理造成的任何损失。

在某些场合中,为了推进安全相关应用有可能对 TI 组件进行特别的促销。TI 的目标是利用此类组件帮助客户设计和创立其特有的可满足适用的功能安全性标准和要求的终端产品解决方案。尽管如此,此类组件仍然服从这些条款。

TI 组件未获得用于 FDA Class III (或类似的生命攸关医疗设备)的授权许可,除非各方授权官员已经达成了专门管控此类使用的特别协议。

只有那些 TI 特别注明属于军用等级或“增强型塑料”的 TI 组件才是设计或专门用于军事/航空应用或环境的。购买者认可并同意,对并非指定面向军事或航空航天用途的 TI 组件进行军事或航空航天方面的应用,其风险由客户单独承担,并且由客户独立负责满足与此类使用相关的所有法律和法规要求。

TI 已明确指定符合 ISO/TS16949 要求的产品,这些产品主要用于汽车。在任何情况下,因使用非指定产品而无法达到 ISO/TS16949 要求, TI 不承担任何责任。

	产品		应用
数字音频	www.ti.com.cn/audio	通信与电信	www.ti.com.cn/telecom
放大器和线性器件	www.ti.com.cn/amplifiers	计算机及周边	www.ti.com.cn/computer
数据转换器	www.ti.com.cn/dataconverters	消费电子	www.ti.com.cn/consumer-apps
DLP® 产品	www.dlp.com	能源	www.ti.com.cn/energy
DSP - 数字信号处理器	www.ti.com.cn/dsp	工业应用	www.ti.com.cn/industrial
时钟和计时器	www.ti.com.cn/clockandtimers	医疗电子	www.ti.com.cn/medical
接口	www.ti.com.cn/interface	安防应用	www.ti.com.cn/security
逻辑	www.ti.com.cn/logic	汽车电子	www.ti.com.cn/automotive
电源管理	www.ti.com.cn/power	视频和影像	www.ti.com.cn/video
微控制器 (MCU)	www.ti.com.cn/microcontrollers		
RFID 系统	www.ti.com.cn/rfidsys		
OMAP应用处理器	www.ti.com/omap		
无线连通性	www.ti.com.cn/wirelessconnectivity	德州仪器在线技术支持社区	www.deyisupport.com

邮寄地址: 上海市浦东新区世纪大道1568号, 中建大厦32楼邮政编码: 200122
Copyright © 2016, 德州仪器半导体技术(上海)有限公司

PACKAGING INFORMATION

Orderable Device	Status (1)	Package Type	Package Drawing	Pins	Package Qty	Eco Plan (2)	Lead finish/ Ball material (6)	MSL Peak Temp (3)	Op Temp (°C)	Device Marking (4/5)	Samples
INA301A1IDGKR	ACTIVE	VSSOP	DGK	8	2500	RoHS & Green	NIPDAUAG	Level-2-260C-1 YEAR	-40 to 125	ZGD6	Samples
INA301A1IDGKT	ACTIVE	VSSOP	DGK	8	250	RoHS & Green	NIPDAUAG	Level-2-260C-1 YEAR	-40 to 125	ZGD6	Samples
INA301A2IDGKR	ACTIVE	VSSOP	DGK	8	2500	RoHS & Green	NIPDAUAG	Level-2-260C-1 YEAR	-40 to 125	ZGI6	Samples
INA301A2IDGKT	ACTIVE	VSSOP	DGK	8	250	RoHS & Green	NIPDAUAG	Level-2-260C-1 YEAR	-40 to 125	ZGI6	Samples
INA301A3IDGKR	ACTIVE	VSSOP	DGK	8	2500	RoHS & Green	NIPDAUAG	Level-2-260C-1 YEAR	-40 to 125	ZGH6	Samples
INA301A3IDGKT	ACTIVE	VSSOP	DGK	8	250	RoHS & Green	NIPDAUAG	Level-2-260C-1 YEAR	-40 to 125	ZGH6	Samples

(1) The marketing status values are defined as follows:

ACTIVE: Product device recommended for new designs.

LIFEBUY: TI has announced that the device will be discontinued, and a lifetime-buy period is in effect.

NRND: Not recommended for new designs. Device is in production to support existing customers, but TI does not recommend using this part in a new design.

PREVIEW: Device has been announced but is not in production. Samples may or may not be available.

OBSELETE: TI has discontinued the production of the device.

(2) **RoHS:** TI defines "RoHS" to mean semiconductor products that are compliant with the current EU RoHS requirements for all 10 RoHS substances, including the requirement that RoHS substance do not exceed 0.1% by weight in homogeneous materials. Where designed to be soldered at high temperatures, "RoHS" products are suitable for use in specified lead-free processes. TI may reference these types of products as "Pb-Free".

RoHS Exempt: TI defines "RoHS Exempt" to mean products that contain lead but are compliant with EU RoHS pursuant to a specific EU RoHS exemption.

Green: TI defines "Green" to mean the content of Chlorine (Cl) and Bromine (Br) based flame retardants meet JS709B low halogen requirements of <=1000ppm threshold. Antimony trioxide based flame retardants must also meet the <=1000ppm threshold requirement.

(3) MSL, Peak Temp. - The Moisture Sensitivity Level rating according to the JEDEC industry standard classifications, and peak solder temperature.

(4) There may be additional marking, which relates to the logo, the lot trace code information, or the environmental category on the device.

(5) Multiple Device Markings will be inside parentheses. Only one Device Marking contained in parentheses and separated by a "~" will appear on a device. If a line is indented then it is a continuation of the previous line and the two combined represent the entire Device Marking for that device.

(6) Lead finish/Ball material - Orderable Devices may have multiple material finish options. Finish options are separated by a vertical ruled line. Lead finish/Ball material values may wrap to two lines if the finish value exceeds the maximum column width.

Important Information and Disclaimer: The information provided on this page represents TI's knowledge and belief as of the date that it is provided. TI bases its knowledge and belief on information provided by third parties, and makes no representation or warranty as to the accuracy of such information. Efforts are underway to better integrate information from third parties. TI has taken and continues to take reasonable steps to provide representative and accurate information but may not have conducted destructive testing or chemical analysis on incoming materials and chemicals. TI and TI suppliers consider certain information to be proprietary, and thus CAS numbers and other limited information may not be available for release.

In no event shall TI's liability arising out of such information exceed the total purchase price of the TI part(s) at issue in this document sold by TI to Customer on an annual basis.

DGK (S-PDSO-G8)

PLASTIC SMALL-OUTLINE PACKAGE



- NOTES:
- A. All linear dimensions are in millimeters.
 - B. This drawing is subject to change without notice.
 - C. Body length does not include mold flash, protrusions, or gate burrs. Mold flash, protrusions, or gate burrs shall not exceed 0.15 per end.
 - D. Body width does not include interlead flash. Interlead flash shall not exceed 0.50 per side.
 - E. Falls within JEDEC MO-187 variation AA, except interlead flash.



- NOTES:
- A. All linear dimensions are in millimeters.
 - B. This drawing is subject to change without notice.
 - C. Publication IPC-7351 is recommended for alternate designs.
 - D. Laser cutting apertures with trapezoidal walls and also rounding corners will offer better paste release. Customers should contact their board assembly site for stencil design recommendations. Refer to IPC-7525 for other stencil recommendations.
 - E. Customers should contact their board fabrication site for solder mask tolerances between and around signal pads.

重要声明和免责声明

TI 均以“原样”提供技术性及其可靠性数据（包括数据表）、设计资源（包括参考设计）、应用或其他设计建议、网络工具、安全信息和其他资源，不保证其中不含任何瑕疵，且不做任何明示或暗示的担保，包括但不限于对适销性、适合某特定用途或不侵犯任何第三方知识产权的暗示担保。

所述资源可供专业开发人员应用TI 产品进行设计使用。您将对以下行为独自承担全部责任：(1) 针对您的应用选择合适的TI 产品；(2) 设计、验证并测试您的应用；(3) 确保您的应用满足相应标准以及任何其他安全、安保或其他要求。所述资源如有变更，恕不另行通知。TI 对您使用所述资源的授权仅限于开发资源所涉及TI 产品的相关应用。除此之外不得复制或展示所述资源，也不提供其它TI 或任何第三方的知识产权授权许可。如因使用所述资源而产生任何索赔、赔偿、成本、损失及债务等，TI 对此概不负责，并且您须赔偿由此对TI 及其代表造成的损害。

TI 所提供产品均受TI 的销售条款 (<http://www.ti.com.cn/zh-cn/legal/termsofsale.html>) 以及 [ti.com.cn](http://www.ti.com.cn) 上或随附TI 产品提供的其他可适用条款的约束。TI 提供所述资源并不扩展或以其他方式更改TI 针对TI 产品所发布的可适用的担保范围或担保免责声明。

邮寄地址：上海市浦东新区世纪大道 1568 号中建大厦 32 楼，邮政编码：200122

Copyright © 2020 德州仪器半导体技术（上海）有限公司