

## SIMPLE -48-V HOT SWAP CONTROLLER

### FEATURES

- Wide Input Supply Range: -36 V to -80 V
- Transient Rating to -100 V
- Programmable Current Limit
- Programmable Current Slew Rate
- Enable Input (EN)
- Fault Timer to Eliminate Nuisance Trips
- Open-Drain Fault Output ( $\overline{\text{FAULT}}$ )
- Requires Few External Components
- 8-Pin MSOP Package

### APPLICATIONS

- -48-V Distributed Power Systems
- Central Office Switching
- Wireless Base Station

### DESCRIPTION

The TPS2390 and TPS2391 integrated circuits are hot swap power managers optimized for use in nominal -48-V systems. They are designed for supply voltage ranges up to -80 V, and are rated to withstand spikes to -100 V. In conjunction with an external N-channel FET and sense resistor, they can be used to enable live insertion of plug-in cards and modules in powered systems. Both devices provide load current slew rate and peak magnitude limiting, easily programmed by sense resistor value and a single-external capacitor. They also provide single-line fault reporting, electrical isolation of faulty cards, and protection against nuisance overcurrent trips. The TPS2390 latches off in response to current faults, while the TPS2391 periodically retries the load in the event of a fault.

### APPLICATION DIAGRAM

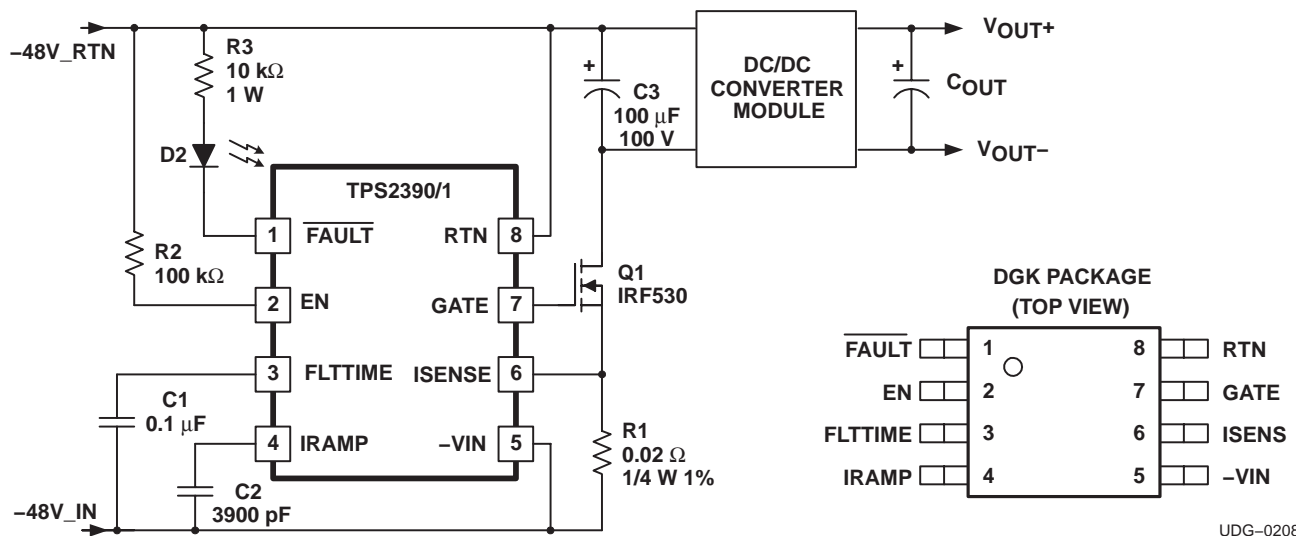

Please be aware that an important notice concerning availability, standard warranty, and use in critical applications of Texas Instruments semiconductor products and disclaimers thereto appears at the end of this data sheet.

**ABSOLUTE MAXIMUM RATINGS (See Note 1)**

|   | <b>TPS2390/1</b>             | <b>UNIT</b> |
|---|------------------------------|-------------|
| Input voltage range, all pins except RTN, EN, $\overline{\text{FAULT}}$ (2) | -0.3 V to 15                 | V           |
| Input voltage range, RTN(2)   | -0.3 V to 100                | V           |
| Input voltage range, EN(2)(3)   | -0.3 V to 100                | V           |
| Output voltage range, $\overline{\text{FAULT}}$ (2)(4)                      | -0.3 V to 100                | V           |
| Continuous output current, $\overline{\text{FAULT}}$                        | 10                           | mA          |
| Continuous total power dissipation  | see Dissipation Rating Table |             |
| Operating junction temperature range, $T_J$                                 | -55°C to 125°C               | °C          |
| Storage temperature range, $T_{\text{stg}}$                                 | -65°C to 150°C               | °C          |
| Lead temperature soldering 1,6 mm (1/16 inch) from case for 10 seconds      | 260°C                        | °C          |

NOTES 1: Stresses beyond those listed under "absolute maximum ratings" may cause permanent damage to the device. These are stress ratings only and functional operation of the device at these or any other conditions beyond those indicated under "recommended operating conditions" is not implied. Exposure to absolute-maximum-rated conditions for extended periods may affect device reliability.

2: All voltages are with respect to -VIN (unless otherwise noted).

3: With 100-kΩ minimum input series resistance, -0.3 V to 15 V with low impedance.

4: With 10-kΩ minimum series resistance, -0.3 V to 80 V with low impedance.

**ELECTROSTATIC DISCHARGE (ESD) PROTECTION**

|                            | <b>MIN</b> | <b>UNIT</b> |
|----------------------------|------------|-------------|
| Human Body Model (HBM)     | 1.5        | kV          |
| Charged Device Model (CDM) | 1.5        | kV          |

**RECOMMENDED OPERATING CONDITIONS†**

|                                      | <b>MIN</b> | <b>NOM</b> | <b>MAX</b> | <b>UNIT</b> |
|--------------------------------------|------------|------------|------------|-------------|
| Nominal input supply, -VIN to RTN    | -80        |            | -36        | V           |
| Operating junction temperature range | -40        |            | 85         | °C          |

† All voltages are with respect to -VIN (unless otherwise noted)

**DISSIPATION RATING TABLE**

| <b>PACKAGE</b> | <b><math>T_A &lt; 25^\circ\text{C}</math><br/>POWER RATING</b> | <b>DERATING FACTOR<br/>ABOVE <math>T_A = 25^\circ\text{C}</math></b> | <b><math>T_A = 85^\circ\text{C}</math><br/>POWER RATING</b> |
|----------------|--|--|---|
| MSOP-8         | 420 mW   | 4.3 mW/°C  | 160 mW  |

**AVAILABLE OPTIONS**

| <b>OPERATING<br/><math>T_A</math></b> | <b>FAULT<br/>OPERATION</b> | <b>PACKAGED DEVICES<br/>MSOP (DGK)</b> |
|---------------------------------------|----------------------------|--|
| -40°C to 85°C                         | Latch off                  | TPS2390DGK                             |
|                                       | Periodically retry         | TPS2391DGK                             |

**ELECTRICAL CHARACTERISTICS**

$V_{I(-VIN)} = -48$  V with respect to RTN,  $V_{I(EN)} = 2.8$  V,  $V_{I(ISENS)} = 0$ , all outputs unloaded,  $T_A = -40^\circ\text{C}$  to  $85^\circ\text{C}$  (unless otherwise noted)<sup>(1)(2)</sup>

**input supply**

| PARAMETER           |                                      | TEST CONDITIONS                    | MIN | TYP  | MAX  | UNIT |
|---------------------|--------------------------------------|------------------------------------|-----|------|------|------|
| I <sub>CC1</sub>    | Supply current, RTN                  | $V_{I(RTN)} = 48$ V                |     | 700  | 1000 | μA   |
| I <sub>CC2</sub>    | Supply current, RTN                  | $V_{I(RTN)} = 80$ V                |     | 1000 | 1500 | μA   |
| V <sub>UVLO_L</sub> | UVLO threshold, input voltage rising | To GATE pull-up, referenced to RTN | -36 | -30  | -25  | V    |
| V <sub>HYS</sub>    | UVLO hysteresis                      |                                    | 1.8 | 2.3  | 3.0  | V    |

**enable input (EN)**

| PARAMETER           |   | TEST CONDITIONS   | MIN | TYP | MAX | UNIT |
|---------------------|---|-------------------|-----|-----|-----|------|
| V <sub>TH</sub>     | Threshold voltage, input voltage rising | To GATE pull-up   | 1.3 | 1.4 | 1.5 | V    |
| V <sub>HYS_EN</sub> | EN hysteresis                           |                   | 30  | 60  | 90  | mV   |
| I <sub>IH</sub>     | High-level input current                | $V_{I(EN)} = 5$ V | -2  | 1   | 2   | μA   |

**linear current amplifier (LCA)**

| PARAMETER          |                                  | TEST CONDITIONS   | MIN | TYP | MAX | UNIT |
|--------------------|----------------------------------|---|-----|-----|-----|------|
| V <sub>OH</sub>    | High-level output, GATE          | $V_{I(ISENS)} = 0$ V                                    | 11  | 14  | 17  | V    |
| I <sub>SINK</sub>  | Output sink current              | $V_{I(ISENS)} = 80$ mV, $V_{O(GATE)} = 5$ V, Fault mode | 50  | 100 |     | mA   |
| I <sub>I</sub>     | Input current, I <sub>SENS</sub> | $0$ V < $V_{I(ISENS)} < 0.2$ V                          | -1  |     | 1   | μA   |
| V <sub>REF_K</sub> | Reference clamp voltage          | $V_{O(IRAMP)} = \text{open}$                            | 33  | 40  | 46  | mV   |
| V <sub>IO</sub>    | Input offset voltage             | $V_{O(IRAMP)} = 2$ V                                    | -7  |     | 6   | mV   |

**ramp generator**

| PARAMETER         |   | TEST CONDITIONS           | MIN  | TYP  | MAX  | UNIT |
|-------------------|---|---------------------------|------|------|------|------|
| I <sub>SRC1</sub> | IRAMP source current, slow turn-on rate     | $V_{O(IRAMP)} = 0.25$ V   | -850 | -600 | -400 | nA   |
| I <sub>SRC2</sub> | IRAMP source current, normal rate           | $V_{O(IRAMP)} = 1$ V, 3 V | -11  | -10  | -9   | μA   |
| V <sub>OL</sub>   | Low-level output voltage                    | $V_{I(EN)} = 0$ V         |      |      | 2    | mV   |
| A <sub>v</sub>    | Voltage gain, relative to I <sub>SENS</sub> | $V_{O(IRAMP)} = 1$ V, 3 V | 9.5  | 10.0 | 10.5 | mV/V |

**overload comparator**

| PARAMETER          |   | TEST CONDITIONS         | MIN | TYP | MAX | UNIT |
|--------------------|---|-------------------------|-----|-----|-----|------|
| V <sub>TH_OL</sub> | Current overload threshold, I <sub>SENS</sub> |                         | 80  | 100 | 120 | mV   |
| t <sub>DLY</sub>   | Glitch filter delay time                      | $V_{I(ISENS)} = 200$ mV | 2   | 4   | 7   | μs   |

**fault timer**

| PARAMETER        |                                      | TEST CONDITIONS   | MIN  | TYP  | MAX  | UNIT |
|------------------|--------------------------------------|---|------|------|------|------|
| V <sub>OL</sub>  | Low-level output voltage             | $V_{I(EN)} = 0$ V   |      |      | 5    | mV   |
| I <sub>CHG</sub> | Charging current, current limit mode | $V_{I(ISENS)} = 80$ mV, $V_{O(FLTTIME)} = 2$ V            | -55  | -50  | -45  | μA   |
| V <sub>FLT</sub> | Fault threshold voltage              |   | 3.75 | 4.00 | 4.25 | V    |
| I <sub>DSG</sub> | Discharge current, retry mode        | TPS2391<br>$V_{I(ISENS)} = 80$ mV, $V_{O(FLTTIME)} = 2$ V |      | 0.38 | 0.75 | μA   |
| D                | Output duty cycle                    | TPS2391   |      | 1    | 1.5  | %    |
| I <sub>RST</sub> | Discharge current, timer reset mode  | $V_{O(FLTTIME)} = 2$ V, $V_{I(ISENS)} = 0$ V              |      | 1    |      | mA   |

NOTES 1: All voltages are with respect to the -VIN terminal unless otherwise stated.  
 2: Currents are positive into and negative out of the specified terminal.

**ELECTRICAL CHARACTERISTICS (continued)**

$V_{I(-VIN)} = -48\text{ V}$  with respect to RTN,  $V_{I(EN)} = 2.8\text{ V}$ ,  $V_{I(ISENS)} = 0$ , all outputs unloaded,  $T_A = -40^\circ\text{C}$  to  $85^\circ\text{C}$  (unless otherwise noted)<sup>(1)(2)</sup>

**FAULT output**

| PARAMETER    |                                     | TEST CONDITIONS   | MIN | TYP | MAX | UNIT          |
|--------------|-------------------------------------|---|-----|-----|-----|---------------|
| $I_{OH}$     | High-level output (leakage) current | $V_{I(EN)} = 0\text{ V}$ , $V_{O(FAULT)} = 65\text{ V}$   |     |     | 10  | $\mu\text{A}$ |
| $R_{DS(ON)}$ | Driver ON resistance                | $V_{I(ISENS)} = 80\text{ mV}$ , $V_{O(FLTTIME)} = 5\text{ V}$ ,<br>$I_{O(FAULT)} = 1\text{ mA}$ |     | 35  | 60  | $\Omega$      |

NOTES 1: All voltages are with respect to the  $-VIN$  terminal unless otherwise stated.  
2: Currents are positive into and negative out of the specified terminal.

**TERMINAL FUNCTIONS**

| TERMINAL |     | I/O | DESCRIPTION  |
|----------|-----|-----|--|
| NAME     | NO. |     |  |
| EN       | 2   | I   | Enable input to turn on/off power to the load.                       |
| FAULT    | 1   | O   | Open-drain, active-low indication of a load fault condition.         |
| FLTTIME  | 3   | I/O | Connection for user-programming of the fault timeout period.         |
| GATE     | 7   | O   | Gate drive for external N-channel FET.                               |
| IRAMP    | 4   | I/O | Programming input for setting the inrush current slew rate.          |
| ISENS    | 6   | I   | Current sense input.   |
| RTN      | 8   | I   | Positive supply input for the TPS2390 and TPS2391.                   |
| $-VIN$   | 5   | I   | Negative supply input and reference pin for the TPS2390 and TPS2391. |

**DETAILED PIN DESCRIPTIONS**

**EN:** Enable input to turn on/off power to the load. The EN pin is referenced to the  $-VIN$  potential of the circuit. When this input is pulled high (above the nominal 1.4-V threshold) the device enables the GATE output, and begins the ramp of current to the load. When this input is low, the linear current amplifier (LCA) is disabled, and a large pull-down device is applied to the FET gate, disabling power to the load.

**FAULT:** Open-drain, active-low indication of a load fault condition. When the device EN is deasserted, or when enabled and the load current is less than the programmed limit, this output is high impedance. If the device remains in current regulation mode at the expiration of the fault timer, or if a fast-acting overload condition causes greater than 100-mV drop across the sense resistor, the fault is latched, the load is turned off, and the  $\overline{\text{FAULT}}$  pin is pulled low (to  $-VIN$ ). The TPS2390 remains latched off for a fault, and can be reset by cycling either the EN pin or power to the device. The TPS2391 retries the load at approximately a 1% duty cycle.

**FLTTIME:** Connection for user-programming of the fault timeout period. An external capacitor connected from FLTTIME to  $-VIN$  establishes the timeout period to declare a fault condition. This timeout protects against indefinite current sourcing into a faulted load, and also provides a filter against nuisance trips from momentary current spikes or surges. The TPS2390 and TPS2391 define a fault condition as voltage at the ISENS pin at or greater than the 40-mV fault threshold. When a fault condition exists, the timer is active. The devices manage fault timing by charging the external capacitor to the 4-V fault threshold, then subsequently discharging it to reset the timer (TPS2390), or discharging it at approximately 1% the charge rate to establish the duty cycle for retrying the load (TPS2391). Whenever the internal fault latch is set (timer expired), the pass FET is rapidly turned off, and the  $\overline{\text{FAULT}}$  output is asserted.

## DETAILED PIN DESCRIPTIONS (continued)

**GATE:** Gate drive for external N-channel FET. When enabled, and the input supply is above the UVLO threshold, the gate drive is enabled and the device begins charging an external capacitor connected to the IRAMP pin. This pin voltage is used to develop the reference voltage at the non-inverting input of the internal LCA. The inverting input is connected to the current sense node, ISENS. The LCA acts to slew the pass FET gate to force the ISENS voltage to track the reference. The reference is internally clamped at 40 mV, so the maximum current that can be sourced to the load is determined by the sense resistor value as  $I_{MAX} \leq 40 \text{ mV}/R_{SENSE}$ . Once the load voltage has ramped up to the input dc potential, and current demand drops off, the LCA drives the GATE output to about 14 V to fully enhance the pass FET, completing the low-impedance supply return path for the load.

**IRAMP:** Programming input for setting the inrush current slew rate. An external capacitor connected between this pin and –VIN establishes the load current slew rate whenever power to the load is enabled. The device charges the external capacitor to establish the reference input to the LCA. The closed-loop control of the LCA and pass FET acts to maintain the current sense voltage at ISENS at the reference potential. Since the sense voltage is developed as the drop across a resistor, the charging current ramp rate is set by the voltage ramp rate at the IRAMP pin. When the output is disabled via the EN input or due to a load fault, the capacitor is discharged and held low to initialize for the next turn-on.

**ISENS:** Current sense input. An external low value resistor connected between this pin and –VIN is used to feed back current magnitude information to the TPS2390/91. There are two internal device thresholds associated with the voltage at the ISENS pin. During ramp-up of the load's input capacitance, or during other periods of excessive demand, the HSPM acts to limit this voltage to 40 mV. Whenever the LCA is in current regulation mode, the capacitor at FLTIME is charged to activate the timer. If, when the LCA is driving to its supply rail, a fast-acting fault such as a short-circuit, causes the ISENS voltage to exceed 100 mV (the overload threshold), the GATE pin is pulled low rapidly, bypassing the fault timer.

**RTN:** Positive supply input for the TPS2390/91. For negative voltage systems, the supply pin connects directly to the return node of the input power bus. Internal regulators step down the input voltage to generate the various supply levels used by the TPS2390 and TPS2391.

**–VIN:** Negative supply input and reference pin for the TPS2390/91. This pin connects directly to the input supply negative rail. The input and output pins and all internal circuitry are referenced to this pin, so it is essentially the GND or VSS pin of the device.

TYPICAL CHARACTERISTICS

LIVE INSERTION EVENT  
VIN = -48 V

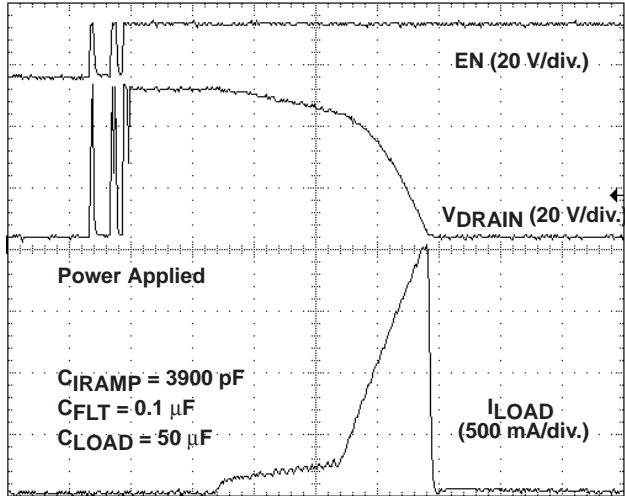

t - Time - 1 ms/div

Figure 1

LIVE INSERTION EVENT  
VIN = -80 V

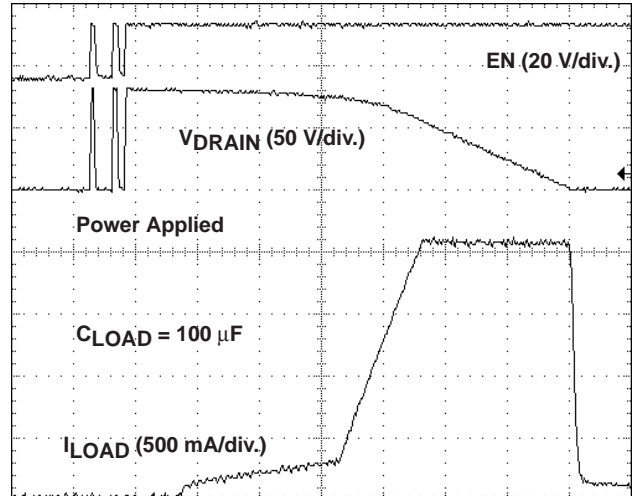

t - Time - 1 ms/div

Figure 2

START-UP FROM ENABLE ASSERTION

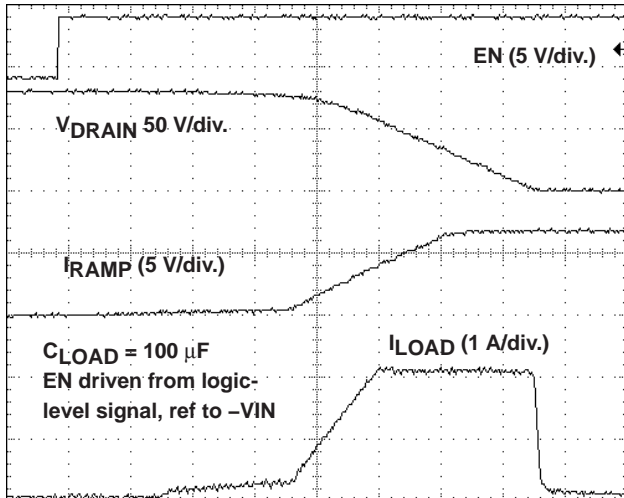

t - Time - 1 ms/div

Figure 3

LOAD CURRENT RAMP PROFILES

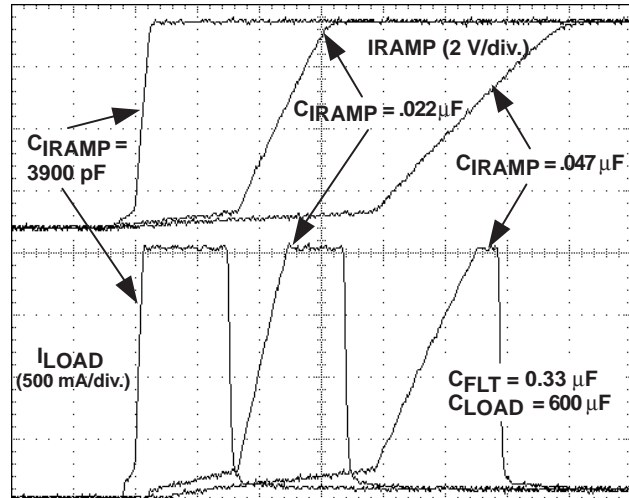

t - Time - 10 ms/div

Figure 4

TYPICAL CHARACTERISTICS

TURN-ON INTO SHORTED LOAD  
(TPS2391)

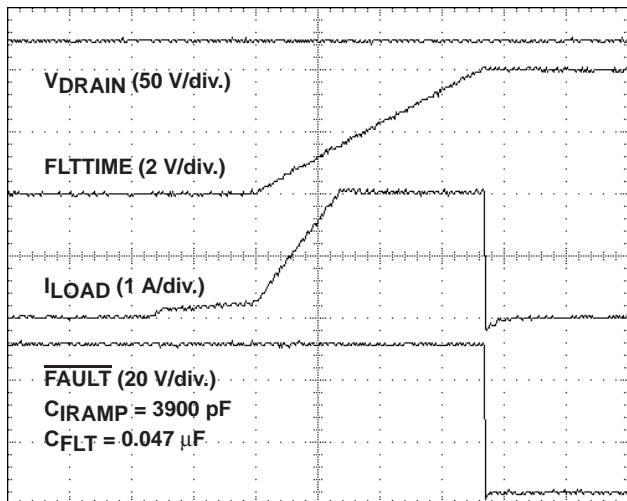

t – Time – 1 ms/div

Figure 5

TURN-ON INTO SHORTED LOAD  
(TPS2390)

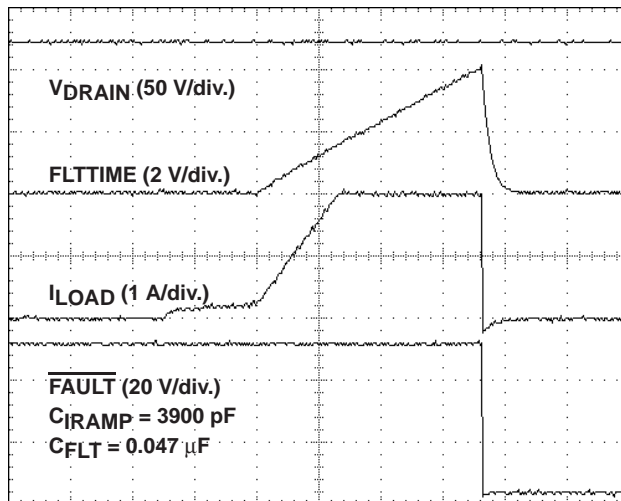

t – Time – 1 ms/div

Figure 6

FAULT RETRY OPERATION  
(TPS2391)

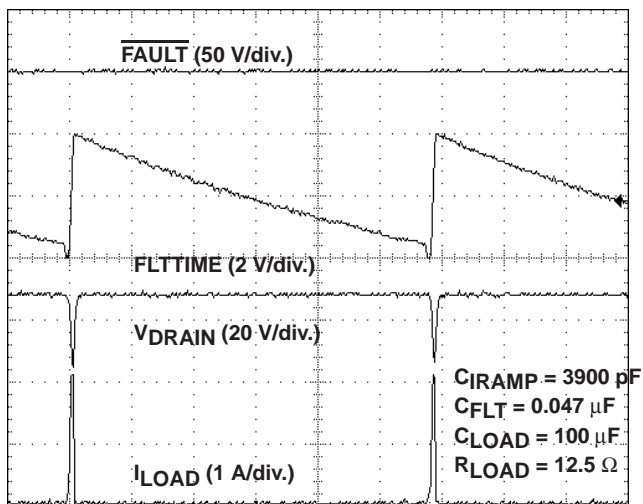

t – Time – 50 ms/div

Figure 7

RECOVERY FROM A FAULT – LARGE SCALE VIEW  
(TPS2391)

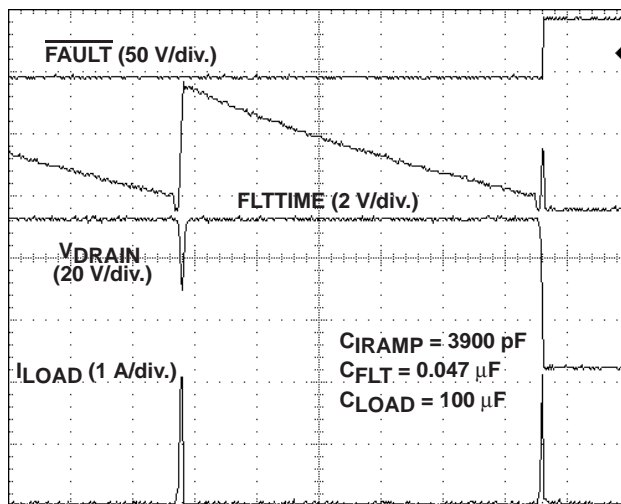

t – Time – 50 ms/div

Figure 8

TYPICAL CHARACTERISTICS

RECOVERY FROM A FAULT – EXPANDED VIEW  
(TPS2391)

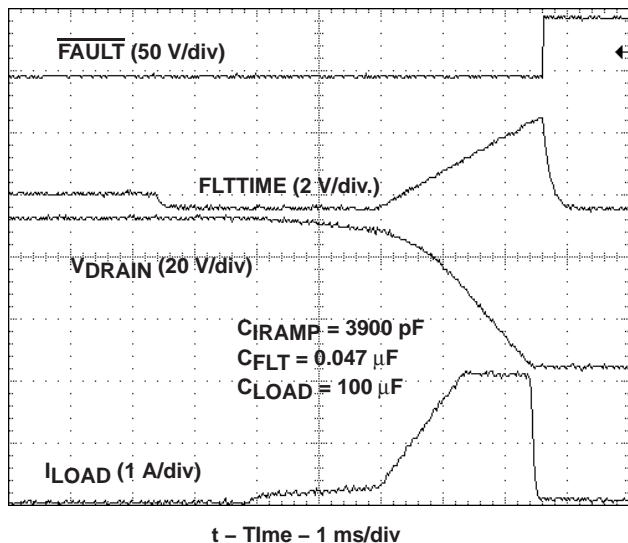

Figure 9

SUPPLY CURRENT  
vs  
AMBIENT TEMPERATURE

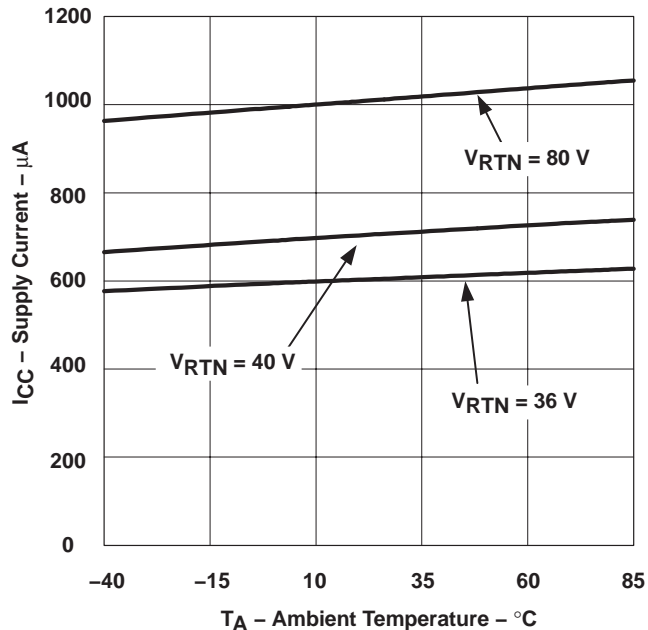

Figure 10

GATE HIGH-LEVEL OUTPUT  
vs  
AMBIENT TEMPERATURE

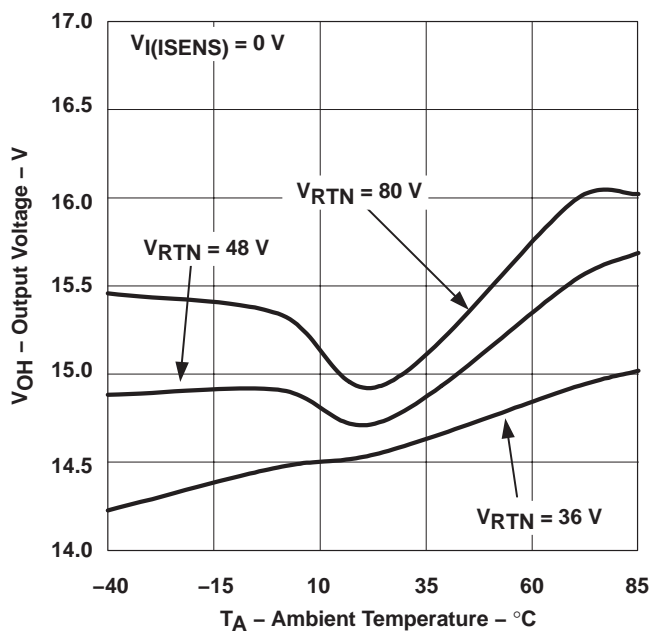

Figure 11

IRAMP OUTPUT CURRENT  
vs  
AMBIENT TEMPERATURE, SLOW TURN-ON

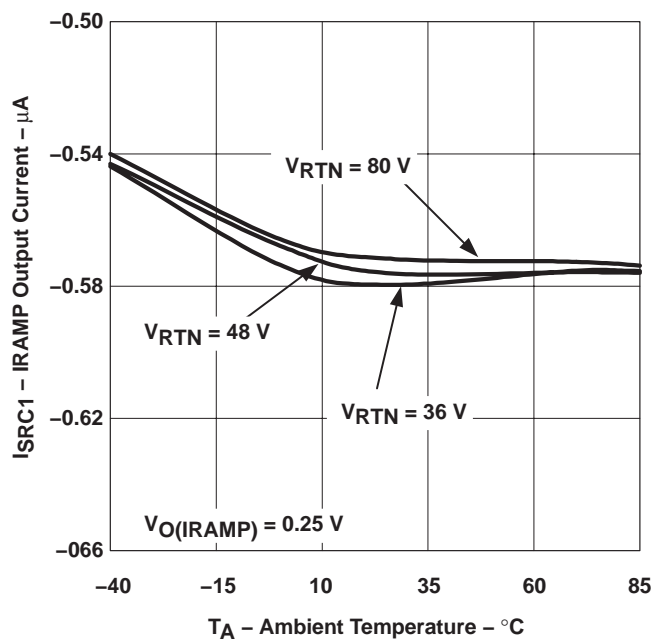
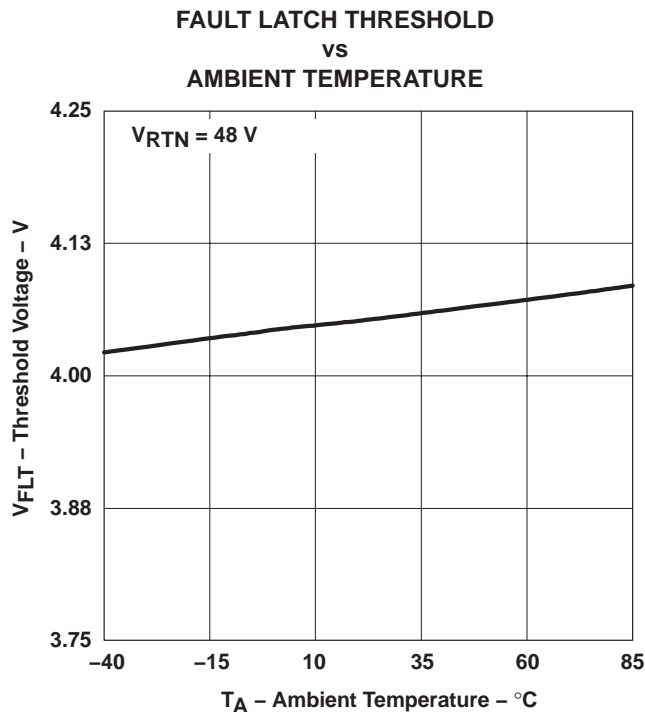
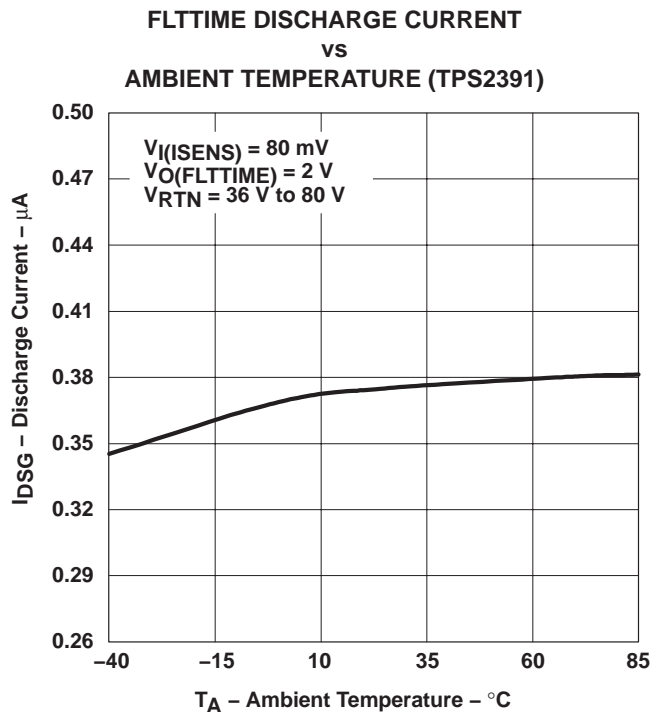
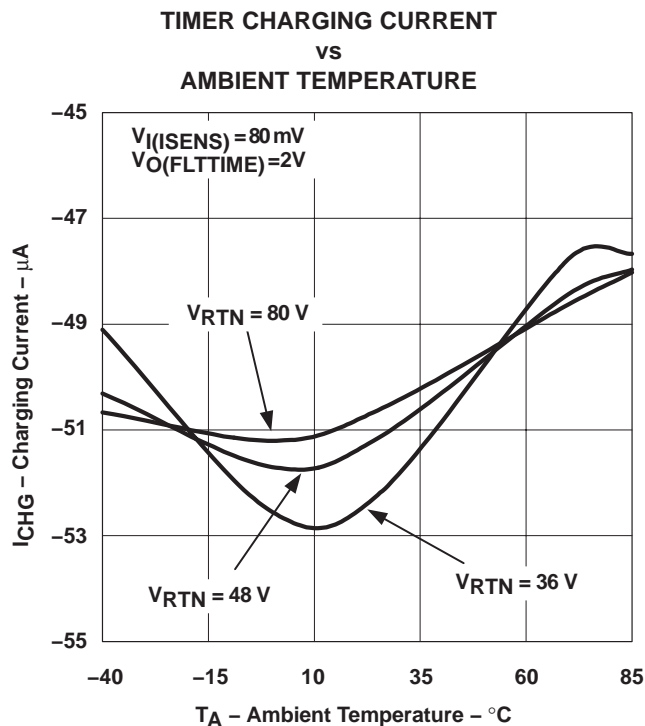
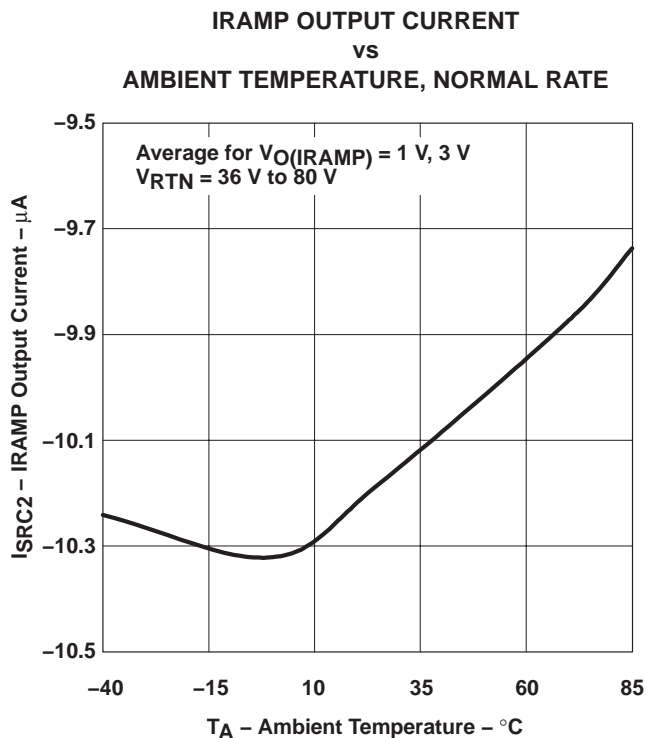

Figure 12

TYPICAL CHARACTERISTICS



## APPLICATION INFORMATION

When a plug-in module or printed circuit card is inserted into a live chassis slot, discharged supply bulk capacitance on the board can draw huge transient currents from the system supplies. Without some form of inrush limiting, these currents can reach peak magnitudes ranging up to several hundred amps, particularly in high-voltage systems. Such large transients can damage connector pins, PCB etch, and plug-in and supply components. In addition, current spikes can cause voltage droops on the power distribution bus, causing other boards in the system to reset.

The TPS2390 and TPS2391 are hot swap power managers designed to limit these peaks to preset levels, as well as control the slew rate ( $di/dt$ ) at which charging current ramps to the programmed limit. These devices use an external N-Channel pass FET and sense element to provide closed-loop control of current sourced to the load. Input supply undervoltage lockout (UVLO) protection allows hot swap circuits to turn on automatically with the application of power, or to be controlled with a system command via the EN input. External capacitors control both the current ramp rate, and the time-out period for load voltage ramping. In addition, an internal overload comparator provides circuit breaker protection against shorts occurring during steady-state (post-turn-on) operation of the card.

The TPS2390 and TPS2391 operate directly from the input supply (nominal  $-48$  VDC rail). The  $-VIN$  pin connects to the negative voltage rail, and the RTN pin connects to the supply return. Internal regulators convert input power to the supply levels required by the device circuitry. An input UVLO circuit holds the GATE output low until the supply voltage reaches a nominal 30-V level. A second comparator monitors the EN input; this pin must be pulled above the 1.4-V enable threshold to turn on power to the load.

Once enabled, and when the input supply is above the UVLO threshold, the GATE pull-down is removed, the linear control amplifier (LCA) is enabled, and a large discharge device in the RAMP CONTROL block is turned off. Subsequently, a small current source is now able to charge an external capacitor connected to the IRAMP pin. This results in a linear voltage ramp at IRAMP. The voltage ramp on the capacitor actually has two discrete slopes. As shown in Figure 17, charging current is supplied from either of two sources. Initially at turn-on, the 600-nA source is selected, to provide a slow turn-on rate. This slow turn-on helps ensure that the LCA is pulled out of saturation, and is slewing to the voltage at its non-inverting input before normal rate load charging is allowed. This mechanism helps reduce current steps at turn-on. Once the voltage at the IRAMP pin reaches approximately 0.5 V, an internal comparator deasserts the SLOW signal, and the 10- $\mu$ A source is selected for the remainder of the ramp period.

The voltage at IRAMP is divided down by a factor of 100, and applied to the non-inverting input of the LCA. Load current magnitude information at the ISENS pin is applied to the inverting input. This voltage is developed by connecting the current sense resistor between ISENS and  $-VIN$ . The LCA slews the gate of the external pass FET to force the ISENS voltage to track the divided down IRAMP voltage. Consequently, the load current slew rate tracks the linear voltage ramp at the IRAMP pin, producing a linear  $di/dt$  of the load current. The IRAMP capacitor is charged to about 6.5 V; however, the LCA input is clamped at 40 mV. Therefore, the current sourced to the load during turn-on is limited to a value given by  $IMAX \leq 40 \text{ mV}/R_{SENSE}$ , where  $R_{SENSE}$  is the value of the sense resistor.

The resultant load current, regulated by the controller, charges the module's input bulk capacitance in a safe fashion. Under normal conditions, this capacitance eventually charges up to the dc input potential. At this point, the load demand drops off, and the voltage at ISENS decreases. The LCA now drives the GATE output to its supply rail. The 14-V typical output level ensures sufficient overdrive to fully enhance the external FET, while not exceeding the typical 20-V  $V_{GS}$  rating of common N-Channel power FETs.

APPLICATION INFORMATION

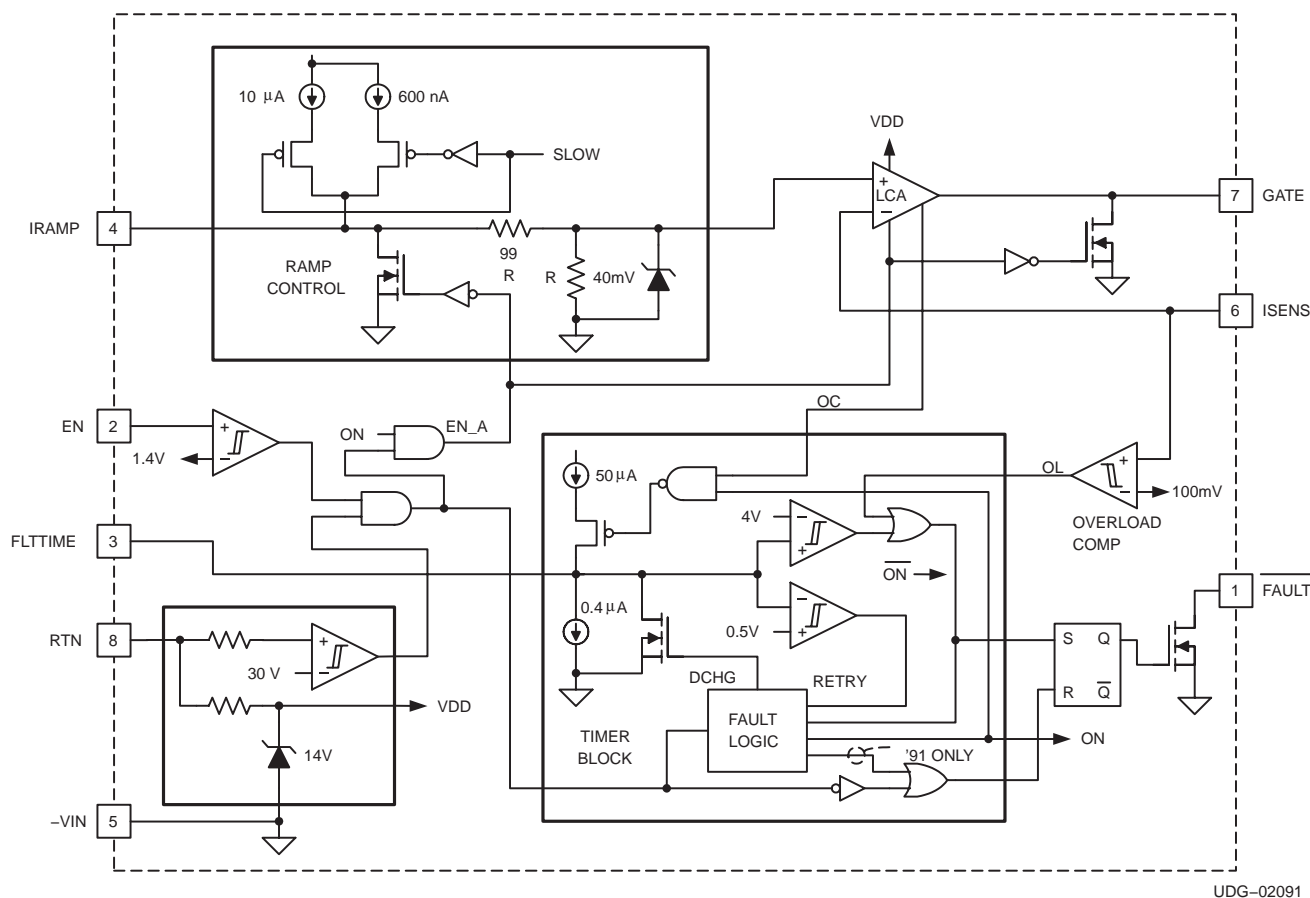

Figure 17. Block Diagram

Fault timing is accomplished by connecting a capacitor between the FLTTIME and  $-VIN$  pins, allowing user-programming of the timeout period. Whenever the hot swap controller is in current control mode as described above, the LCA asserts an overcurrent indication (OC in the Figure 17 diagram). Overcurrent fault timing is inhibited during the slow turn-on portion of the IRAMP waveform. However, once the device transitions to the normal rate current ramp ( $V_O(IRAMP) \geq 0.5 V$ ), the external capacitor is charged by a 50- $\mu A$  source, generating a voltage ramp at the FLTTIME pin. If this voltage reaches the 4-V fault threshold, the fault is latched, and the open-drain driver is turned on to assert the external  $\overline{FAULT}$  output. Fault capacitor charging ceases, and the capacitor is now discharged. In addition, latching of a fault condition causes rapid discharge of the IRAMP capacitor. In this manner, the soft-start function is now reset and ready for the next output enable, if and when conditions permit.

The TPS2390 latches off in response to faults; once a fault timeout occurs, the discharge signal (DCHG) turns on a large NMOS device to rapidly discharge the external capacitor, resetting the timer for any subsequent device reset. The TPS2390 can only be reset by cycling power to the device, or by cycling the EN input.

## APPLICATION INFORMATION

In response to a latched fault condition, the TPS2391 enters a fault retry mode, wherein it periodically retries the load to test for continued existence of the fault. In this mode, the FLTTIME capacitor is discharged slowly by a about a 0.4- $\mu$ A constant-current sink. When the voltage at the FLTTIME pin decays below 0.5 V, the LCA and RAMP CONTROL circuits are re-enabled, and a normal turn-on current ramp ensues. Again, during the load charging, the OC signal causes charging of the FLTTIME capacitor until the next delay period elapses. The sequential charging and discharging of the FLTTIME capacitor results in a typical 1% retry duty cycle. If the fault subsides (GATE pin drives to high-level output), the timing capacitor is rapidly discharged, duty-cycle operation stops, and the fault latch is reset.

Note that because of the timing inhibit during the initial slow ramp period, the duty cycle in practice is slightly greater than the nominal 1% value. However, sourced current during this period peaks at only about one-eighth the maximum limit. The duty cycle of the normal ramp and constant-current periods is approximately 1%.

The FAULT LOGIC within the TIMER BLOCK automatically manages capacitor charge and discharge rates (DCHG signal), and the enabling of the GATE output (ON signal). For the TPS2391, the  $\overline{\text{FAULT}}$  output remains asserted continuously during retry mode; it is only released if the fault condition clears.

These hot swap controllers contain an OVERLOAD COMPARATOR which also monitors the ISENS voltage. If sense voltage excursions above 100 mV are detected, the fault is latched, LCA disabled, and the FET gate is rapidly pulled down, bypassing the fault timer. The timer block does apply a 4- $\mu$ s deglitch filter to the OL signal to help reduce nuisance trips. As with overcurrent faults, the TPS2390 latches the output off. For the TPS2391, an overload fault causes charging of the timer capacitor, to initiate fault retry timing.

### setting the sense resistor value

Due to the current-limiting action of the internal LCA, the maximum allowable load current for an implementation is easily programmed by selecting the appropriate sense resistor value. The LCA acts to limit the sense voltage  $V_I(\text{ISENS})$  to its internal reference. Once the voltage at the IRAMP pin exceeds approximately 4 V, this limit is the clamp voltage,  $V_{\text{REF\_K}}$ . Therefore, a maximum sense resistor value can be determined from equation (1).

$$R_{\text{SENSE}} \leq \frac{33 \text{ mV}}{I_{\text{MAX}}} \quad (1)$$

where:

- $R_{\text{SENSE}}$  is the resistor value, and
- $I_{\text{MAX}}$  is the desired current limit.

## APPLICATION INFORMATION

When setting the sense resistor value, it is important to consider two factors, the minimum current that may be imposed by the TPS2390 or TPS2391, and the maximum load under normal operation of the module. For the first factor, the specification minimum clamp value is used, as seen in equation (1). This method accounts for the tolerance in the sourced current limit below the typical level expected ( $40 \text{ mV}/R_{\text{SENSE}}$ ). (The clamp measurement includes LCA input offset voltage; therefore, this offset does not have to be factored into the current limit again.) Second, if the load current varies over a range of values under normal operating conditions, then the maximum load level must be allowed for by the value of  $R_{\text{SENSE}}$ . One example of this is when the load is a switching converter, or brick, which draws higher input current, for a given power output, when the distribution bus is at the low end of its operating range, with decreasing draw at higher supply voltages. To avoid current-limit operation under normal loading, some margin should be designed in between this maximum anticipated load and the minimum current limit level, or  $I_{\text{MAX}} > I_{\text{LOAD(max)}}$ , for equation (1).

For example, using a 20-m $\Omega$  sense resistor for a nominal 1-A load application provides a minimum of 650 mA of overhead for load variance/margin. Typical bulk capacitor charging current during turn-on is 2 A (40 mV/20 m $\Omega$ ).

### setting the inrush slew rate

The TPS2390 and TPS2391 devices enable user-programming of the maximum current slew rate during load start-up events. A capacitor tied to the IRAMP pin (C2 in the typical application diagram) controls the di/dt rate. Once the sense resistor value has been established, a value for ramp capacitor  $C_{\text{IRAMP}}$ , in microfarads, can be determined from equation (2).

$$C_{\text{IRAMP}} = \frac{11}{100 \times R_{\text{SENSE}} \times \left(\frac{di}{dt}\right)_{\text{MAX}}} \quad (2)$$

where:

- $R_{\text{SENSE}}$  is in ohms, and
- $(di/dt)_{\text{MAX}}$  is the desired maximum slew rate, in amps/second.

For example, if the desired slew rate for the typical application shown is 1500 mA/ms, the calculated value for  $C_{\text{IRAMP}}$  is about 3700 pF. Selecting the next larger standard value of 3900 pF (as shown in the diagram) provides some margin for capacitor and sense resistor tolerances.

As described earlier in this section, the TPS2390 and TPS2391 initiate ramp capacitor charging, and consequently, load current di/dt at a reduced rate. This reduced rate applies until the voltage on the IRAMP pin is about 0.5 V. The maximum di/dt rate, as set by equation (2), is effective once the device has switched to the 10- $\mu$ A charging source.

## APPLICATION INFORMATION

### setting the fault timing capacitor

The fault timeout period is established by the value of the capacitor connected to the FLTTIME pin,  $C_{FLT}$ . The timeout period permits riding out spurious current glitches and surges that may occur during operation of the system, and prevents indefinite sourcing into faulted loads swapped into a live system. However, to ensure smooth voltage ramping under all conditions of load capacitance and input supply potential, the minimum timeout should be set to accommodate these system variables. To do this, a rough estimate of the maximum voltage ramp time for a completely discharged plug-in card provides a good basis for setting the minimum timer delay.

Due to the three-phase nature of the load current at turn-on, the load voltage ramp potentially has three distinct phases ( compare Figures 1 and 2). This profile depends on the relative values of load capacitance, input dc potential, maximum current limit and other factors. The first two phases are characterized by the two different slopes of the current ramp; the third phase, if required for bulk capacitance charging, is the constant-current charging at  $I_{MAX}$ . Considering the two current ramp phases to be one period at an average  $di/dt$  simplifies calculation of the required timing capacitor.

For the TPS2390 and TPS2391, the typical duration of the soft-start ramp period,  $t_{SS}$ , is given by equation (3).

$$t_{SS} = 1183 \times C_{IRAMP} \quad (3)$$

where:

- $t_{SS}$  is the soft-start period in ms, and
- $C_{IRAMP}$  is given in  $\mu F$

During this current ramp period, the load voltage magnitude which is attained is estimated by equation (4).

$$V_{LSS} = \frac{i_{AVG}}{2 \times C_L \times C_{IRAMP} \times 100 \times R_{SENSE}} \times (t_{SS})^2 \quad (4)$$

where:

- $V_{LSS}$  is the load voltage reached during soft-start,
- $i_{AVG}$  is 3.38  $\mu A$  for the TPS2390 and TPS2391,
- $C_L$  is the amount of the load capacitance, and
- $t_{SS}$  is the soft-start period, in seconds

The quantity  $i_{AVG}$  in equation (4) is a weighted average of the two charge currents applied to  $C_{IRAMP}$  during turn-on, considering the typical output values.

## APPLICATION INFORMATION

If the result of equation (4) is larger than the maximum input supply value, then the load can be expected to charge completely during the inrush slewing portion of the insertion event. However, if this voltage is less than the maximum supply input,  $V_{IN(max)}$ , the HSPM transitions to the constant-current charging of the load. The remaining amount of time required at  $I_{MAX}$  is determined from equation (5).

$$t_{CC} = \frac{C_L \times (V_{IN(max)} - V_{LSS})}{\left(\frac{V_{REF\_K(min)}}{R_{SENSE}}\right)} \quad (5)$$

where:

- $t_{CC}$  is the constant-current voltage ramp time, in seconds, and
- $V_{REF\_K(min)}$  is the minimum clamp voltage, 33 mV.

With this information, the minimum recommended value timing capacitor  $C_{FLT}$  can be determined. The delay time needed is either  $t_{SS}$  or the sum of  $t_{SS}$  and  $t_{CC}$ , according to the estimated time to charge the load. Since fault timing is generated by the constant-current charging of  $C_{FLT}$ , the capacitor value is determined by equation (6) or (7).

$$C_{FLT(MIN)} = \frac{55 \times t_{SS}}{3.75} \quad (6)$$

$$C_{FLT(MIN)} = \frac{55 \times (t_{SS} + t_{CC})}{3.75} \quad (7)$$

where:

- $C_{FLT(min)}$  is the recommended capacitor value, in microfarads,
- $t_{SS}$  is the result of equation (3), in seconds, and
- $t_{CC}$  is the result of equation (5), in seconds.

For the typical application example, with the 100- $\mu$ F filter capacitor in front of the dc-to-dc converter, equations (3) and (4) estimate the load voltage ramping to -46 V during the soft-start period. If the module should operate down to -72-V input supply, approximately another 1.58 ms of constant-current charging may be required. Therefore, equation 7 is used to determine  $C_{FLT(min)}$ , and the result is approximately 0.1  $\mu$ F.

**PACKAGING INFORMATION**

| Orderable Device | Status<br>(1) | Package Type | Package Drawing | Pins | Package Qty | Eco Plan<br>(2) | Lead finish/<br>Ball material<br>(6) | MSL Peak Temp<br>(3) | Op Temp (°C) | Device Marking<br>(4/5) | Samples                 |
|------------------|---------------|--------------|-----------------|------|-------------|-----------------|--------------------------------------|----------------------|--------------|-------------------------|-------------------------|
| TPS2390DGK       | ACTIVE        | VSSOP        | DGK             | 8    | 80          | RoHS & Green    | NIPDAUAG                             | Level-2-260C-1 YEAR  | -40 to 85    | 2390                    | <a href="#">Samples</a> |
| TPS2390DGKG4     | ACTIVE        | VSSOP        | DGK             | 8    | 80          | RoHS & Green    | NIPDAUAG                             | Level-2-260C-1 YEAR  | -40 to 85    | 2390                    | <a href="#">Samples</a> |
| TPS2390DGKR      | ACTIVE        | VSSOP        | DGK             | 8    | 2500        | RoHS & Green    | NIPDAUAG                             | Level-2-260C-1 YEAR  | -40 to 85    | 2390                    | <a href="#">Samples</a> |
| TPS2391DGK       | ACTIVE        | VSSOP        | DGK             | 8    | 80          | RoHS & Green    | NIPDAUAG                             | Level-2-260C-1 YEAR  | -40 to 85    | 2391                    | <a href="#">Samples</a> |
| TPS2391DGKR      | ACTIVE        | VSSOP        | DGK             | 8    | 2500        | RoHS & Green    | NIPDAUAG                             | Level-2-260C-1 YEAR  | -40 to 85    | 2391                    | <a href="#">Samples</a> |
| TPS2391DGKRG4    | ACTIVE        | VSSOP        | DGK             | 8    | 2500        | RoHS & Green    | NIPDAUAG                             | Level-2-260C-1 YEAR  | -40 to 85    | 2391                    | <a href="#">Samples</a> |

(1) The marketing status values are defined as follows:

**ACTIVE:** Product device recommended for new designs.

**LIFEBUY:** TI has announced that the device will be discontinued, and a lifetime-buy period is in effect.

**NRND:** Not recommended for new designs. Device is in production to support existing customers, but TI does not recommend using this part in a new design.

**PREVIEW:** Device has been announced but is not in production. Samples may or may not be available.

**OBSOLETE:** TI has discontinued the production of the device.

(2) **RoHS:** TI defines "RoHS" to mean semiconductor products that are compliant with the current EU RoHS requirements for all 10 RoHS substances, including the requirement that RoHS substance do not exceed 0.1% by weight in homogeneous materials. Where designed to be soldered at high temperatures, "RoHS" products are suitable for use in specified lead-free processes. TI may reference these types of products as "Pb-Free".

**RoHS Exempt:** TI defines "RoHS Exempt" to mean products that contain lead but are compliant with EU RoHS pursuant to a specific EU RoHS exemption.

**Green:** TI defines "Green" to mean the content of Chlorine (Cl) and Bromine (Br) based flame retardants meet JS709B low halogen requirements of <=1000ppm threshold. Antimony trioxide based flame retardants must also meet the <=1000ppm threshold requirement.

(3) MSL, Peak Temp. - The Moisture Sensitivity Level rating according to the JEDEC industry standard classifications, and peak solder temperature.

(4) There may be additional marking, which relates to the logo, the lot trace code information, or the environmental category on the device.

(5) Multiple Device Markings will be inside parentheses. Only one Device Marking contained in parentheses and separated by a "~" will appear on a device. If a line is indented then it is a continuation of the previous line and the two combined represent the entire Device Marking for that device.

(6) Lead finish/Ball material - Orderable Devices may have multiple material finish options. Finish options are separated by a vertical ruled line. Lead finish/Ball material values may wrap to two lines if the finish value exceeds the maximum column width.

**Important Information and Disclaimer:** The information provided on this page represents TI's knowledge and belief as of the date that it is provided. TI bases its knowledge and belief on information provided by third parties, and makes no representation or warranty as to the accuracy of such information. Efforts are underway to better integrate information from third parties. TI has taken and continues to take reasonable steps to provide representative and accurate information but may not have conducted destructive testing or chemical analysis on incoming materials and chemicals. TI and TI suppliers consider certain information to be proprietary, and thus CAS numbers and other limited information may not be available for release.

In no event shall TI's liability arising out of such information exceed the total purchase price of the TI part(s) at issue in this document sold by TI to Customer on an annual basis.

**TAPE AND REEL INFORMATION**

**QUADRANT ASSIGNMENTS FOR PIN 1 ORIENTATION IN TAPE**



\*All dimensions are nominal

| Device      | Package Type | Package Drawing | Pins | SPQ  | Reel Diameter (mm) | Reel Width W1 (mm) | A0 (mm) | B0 (mm) | K0 (mm) | P1 (mm) | W (mm) | Pin1 Quadrant |
|-------------|--------------|-----------------|------|------|--------------------|--------------------|---------|---------|---------|---------|--------|---------------|
| TPS2390DGKR | VSSOP        | DGK             | 8    | 2500 | 330.0              | 12.4               | 5.3     | 3.4     | 1.4     | 8.0     | 12.0   | Q1            |
| TPS2391DGKR | VSSOP        | DGK             | 8    | 2500 | 330.0              | 12.4               | 5.3     | 3.4     | 1.4     | 8.0     | 12.0   | Q1            |

**TAPE AND REEL BOX DIMENSIONS**

\*All dimensions are nominal

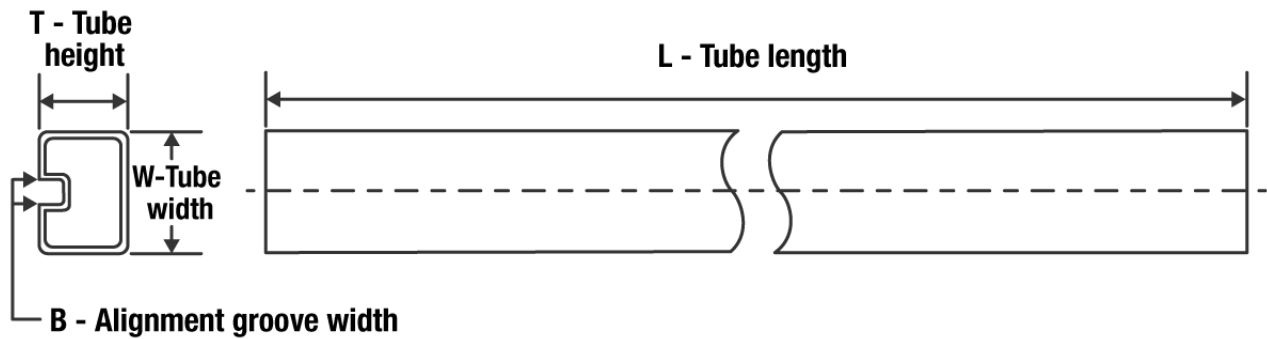
| Device      | Package Type | Package Drawing | Pins | SPQ  | Length (mm) | Width (mm) | Height (mm) |
|-------------|--------------|-----------------|------|------|-------------|------------|-------------|
| TPS2390DGKR | VSSOP        | DGK             | 8    | 2500 | 366.0       | 364.0      | 50.0        |
| TPS2391DGKR | VSSOP        | DGK             | 8    | 2500 | 366.0       | 364.0      | 50.0        |

**TUBE**

\*All dimensions are nominal

| Device       | Package Name | Package Type | Pins | SPQ | L (mm) | W (mm) | T (μm) | B (mm) |
|--------------|--------------|--------------|------|-----|--------|--------|--------|--------|
| TPS2390DGK   | DGK          | VSSOP        | 8    | 80  | 330    | 6.55   | 500    | 2.88   |
| TPS2390DGKG4 | DGK          | VSSOP        | 8    | 80  | 330    | 6.55   | 500    | 2.88   |
| TPS2391DGK   | DGK          | VSSOP        | 8    | 80  | 330    | 6.55   | 500    | 2.88   |

DGK (S-PDSO-G8)

PLASTIC SMALL-OUTLINE PACKAGE

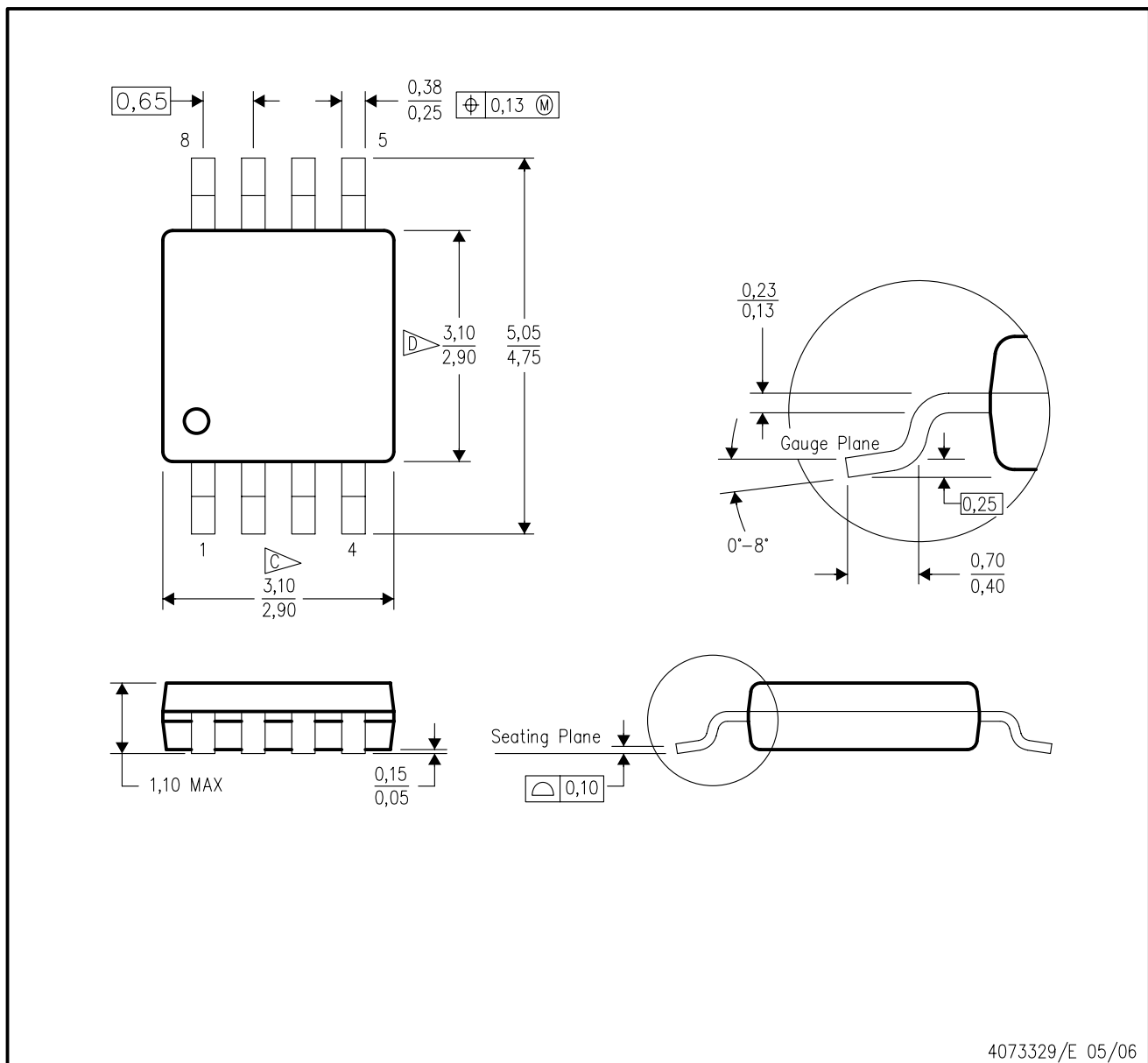

- NOTES:
- A. All linear dimensions are in millimeters.
  - B. This drawing is subject to change without notice.
  - C. Body length does not include mold flash, protrusions, or gate burrs. Mold flash, protrusions, or gate burrs shall not exceed 0.15 per end.
  - D. Body width does not include interlead flash. Interlead flash shall not exceed 0.50 per side.
  - E. Falls within JEDEC MO-187 variation AA, except interlead flash.



- NOTES:
- A. All linear dimensions are in millimeters.
  - B. This drawing is subject to change without notice.
  - C. Publication IPC-7351 is recommended for alternate designs.
  - D. Laser cutting apertures with trapezoidal walls and also rounding corners will offer better paste release. Customers should contact their board assembly site for stencil design recommendations. Refer to IPC-7525 for other stencil recommendations.
  - E. Customers should contact their board fabrication site for solder mask tolerances between and around signal pads.

## IMPORTANT NOTICE AND DISCLAIMER

TI PROVIDES TECHNICAL AND RELIABILITY DATA (INCLUDING DATA SHEETS), DESIGN RESOURCES (INCLUDING REFERENCE DESIGNS), APPLICATION OR OTHER DESIGN ADVICE, WEB TOOLS, SAFETY INFORMATION, AND OTHER RESOURCES "AS IS" AND WITH ALL FAULTS, AND DISCLAIMS ALL WARRANTIES, EXPRESS AND IMPLIED, INCLUDING WITHOUT LIMITATION ANY IMPLIED WARRANTIES OF MERCHANTABILITY, FITNESS FOR A PARTICULAR PURPOSE OR NON-INFRINGEMENT OF THIRD PARTY INTELLECTUAL PROPERTY RIGHTS.

These resources are intended for skilled developers designing with TI products. You are solely responsible for (1) selecting the appropriate TI products for your application, (2) designing, validating and testing your application, and (3) ensuring your application meets applicable standards, and any other safety, security, regulatory or other requirements.

These resources are subject to change without notice. TI grants you permission to use these resources only for development of an application that uses the TI products described in the resource. Other reproduction and display of these resources is prohibited. No license is granted to any other TI intellectual property right or to any third party intellectual property right. TI disclaims responsibility for, and you will fully indemnify TI and its representatives against, any claims, damages, costs, losses, and liabilities arising out of your use of these resources.

TI's products are provided subject to [TI's Terms of Sale](#) or other applicable terms available either on [ti.com](http://ti.com) or provided in conjunction with such TI products. TI's provision of these resources does not expand or otherwise alter TI's applicable warranties or warranty disclaimers for TI products.

TI objects to and rejects any additional or different terms you may have proposed.

Mailing Address: Texas Instruments, Post Office Box 655303, Dallas, Texas 75265  
Copyright © 2022, Texas Instruments Incorporated