

TPS40345 3V 至 20V 输入同步降压控制器

1 特性

- 输入电压范围：3V 至 20V
- 600kHz 开关频率
- 高侧和低侧 FET $R_{DS(on)}$ 电流检测
- 可编程热补偿 OCP 电平
- 可编程软启动
- 600mV、1.3% 基准电压
- 电压前馈补偿
- 支持预偏置输出
- 扩频频谱
- 145°C 的热关断保护限制
- 10 引脚 3mm × 3mm VSON 封装，散热垫具有接地连接

2 应用

- 负载点 (POL) 模块
- 打印机
- 数字电视
- 电信

3 说明

TPS40345 是一款同步降压控制器，可在 3V 到 20V 的输入电压下工作，可用于成本优化型应用。此控制器实现了一种电压模式控制架构，具有输入电压前馈补偿功能，可对输入电压变化做出即时响应。开关频率设置为 600kHz。

开关频率中添加了扩频频谱 (FSS) 功能，显著降低了峰值 EMI 噪声，使其更容易符合 EMI 标准。

TPS40345 可提供各种用户可编程功能，其中包括软启动、过流保护 (OCP) 电平以及环路补偿。

OCP 电平可以通过从 LDRV 引脚连接到电路接地的单个外部电阻器进行编程。在初始上电过程中，TPS40345 可进入校准环节，测量 LDRV 引脚电压，并设置内部 OCP 电压级。在工作期间，器件可在通电时通过将已编程 OCP 电压电平与低侧 FET 上的压降进行比较来确定是否发生过流情况。之后，TPS40345 会进入关断和重启周期，直到故障消除为止。

器件信息(1)

器件型号	封装	封装尺寸 (标称值)
TPS40345	VSON (10)	3.00mm × 3.00mm

(1) 如需了解所有可用封装，请参阅数据表末尾的可订购产品附录。

简化应用示意图

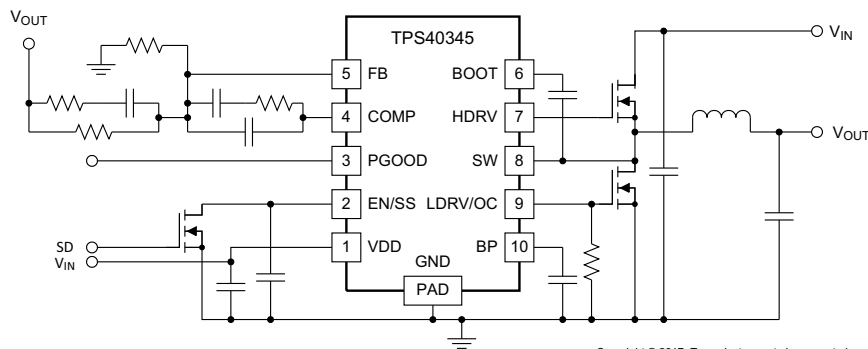

Copyright © 2017, Texas Instruments Incorporated



目录

<p>1 特性 1</p> <p>2 应用 1</p> <p>3 说明 1</p> <p>4 修订历史记录 2</p> <p>5 Pin Configuration and Functions 3</p> <p>6 Specifications 4</p> <p> 6.1 Absolute Maximum Ratings 4</p> <p> 6.2 ESD Ratings 4</p> <p> 6.3 Recommended Operating Conditions 4</p> <p> 6.4 Thermal Information 4</p> <p> 6.5 Electrical Characteristics 5</p> <p> 6.6 Typical Characteristics 7</p> <p>7 Detailed Description 9</p> <p> 7.1 Overview 9</p> <p> 7.2 Functional Block Diagram 9</p> <p> 7.3 Feature Description 9</p> <p> 7.4 Device Functional Modes 12</p>	<p>8 Application and Implementation 13</p> <p> 8.1 Application Information 13</p> <p> 8.2 Typical Applications 13</p> <p>9 Power Supply Recommendations 17</p> <p>10 Layout 18</p> <p> 10.1 Layout Guidelines 18</p> <p> 10.2 Layout Example 19</p> <p>11 器件和文档支持 20</p> <p> 11.1 器件支持 20</p> <p> 11.2 文档支持 20</p> <p> 11.3 接收文档更新通知 20</p> <p> 11.4 社区资源 20</p> <p> 11.5 商标 20</p> <p> 11.6 静电放电警告 20</p> <p> 11.7 Glossary 20</p> <p>12 机械、封装和可订购信息 20</p>
---	--

4 修订历史记录

注：之前版本的页码可能与当前版本有所不同。

日期	修订版本	说明
2017 年 12 月	*	初始发行版

5 Pin Configuration and Functions

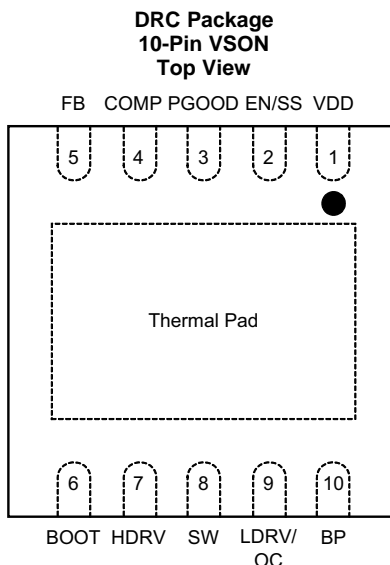

Pin Functions

PIN		I/O	DESCRIPTION
NAME	NO.		
BOOT	6	I	Gate drive voltage for the high-side N-channel MOSFET. A 0.1- μ F capacitor (typical) must be connected between this pin and SW. For low input voltage operation, an external Schottky diode from BP to BOOT is recommended to maximize the gate drive voltage for the high-side.
BP	10	O	Output bypass for the internal regulator. Connect a low ESR bypass ceramic capacitor of 1 μ F or greater from this pin to GND.
COMP	4	O	Output of the error amplifier and connection node for loop feedback components.
EN/SS	2	I	Logic level input which starts or stops the controller via an external user command. Letting this pin float turns the controller on. Pulling this pin low disables the controller. This is also the soft-start programming pin. A capacitor connected from this pin to GND programs the soft-start time. The capacitor is charged with an internal current source of 10 μ A. The resulting voltage ramp of this pin is also used as a second non-inverting input to the error amplifier after a 0.8 V (typical) level shift downwards. Output regulation is controlled by the internal level shifted voltage ramp until that voltage reaches the internal reference voltage of 600 mV – the voltage ramp of this pin reaches 1.4 V (typical). Optionally, a 267-k Ω resistor from this pin to BP enables the FSS feature.
FB	5	I	Inverting input to the error amplifier. In normal operation, the voltage on this pin is equal to the internal reference voltage.
PGOOD	3	O	Open-drain power good output.
HDRV	7	O	Bootstrapped gate drive output for the high-side N-channel MOSFET.
LDRV/OC	9	O	Gate drive output for the low-side synchronous rectifier N-channel MOSFET. A resistor from this pin to GND is also used to determine the voltage level for OCP. An internal current source of 10 μ A flows through the resistor during initial calibration and that sets up the voltage trip point used for OCP.
VDD	1	I	Power input to the controller. Bypass VDD to GND with a low ESR ceramic capacitor of at least 1 μ F close to the device.
SW	8	O	Sense line for the adaptive anti-cross conduction circuitry. Serves as common connection for the flying high-side FET driver.
GND	Thermal Pad	—	Ground connection to the controller. This is also the thermal pad used to conduct heat from the device. This connection serves a twofold purpose. The first is to provide an electrical ground connection for the device. The second is to provide a low thermal impedance path from the device die to the PCB. This pad should be tied externally to a ground plane.

6 Specifications

6.1 Absolute Maximum Ratings

over operating free-air temperature range (unless otherwise noted)⁽¹⁾

	MIN	MAX	UNIT
VDD	-0.3	22	V
SW	-3	27	V
SW (< 100 ns pulse width, 10 μ J)		-5	V
BOOT	-0.3	30	V
HDRV	-5	30	V
BOOT-SW, HDRV-SW (differential from BOOT or HDRV to SW)	-0.3	7	V
COMP, PGOOD, FB, BP, LDRV, EN/SS	-0.3	7	V
Operating junction temperature, T _J	-40	145	°C
Storage temperature, T _{stg}	-55	150	°C

- (1) Stresses beyond those listed under Absolute Maximum Ratings may cause permanent damage to the device. These are stress ratings only and functional operation of the device at these or any other condition beyond those included under [Recommended Operating Conditions](#) is not implied. Exposure to absolute-maximum-rated conditions for extended periods of time may affect device reliability.

6.2 ESD Ratings

		VALUE	UNIT
V _(ESD) Electrostatic discharge	Human-body model (HBM), per ANSI/ESDA/JEDEC JS-001 ⁽¹⁾	±2000	V
	Charged-device model (CDM), per JEDEC specification JESD22-C101 ⁽²⁾	±1500	

- (1) JEDEC document JEP155 states that 500-V HBM allows safe manufacturing with a standard ESD control process.
 (2) JEDEC document JEP157 states that 250-V CDM allows safe manufacturing with a standard ESD control process.

6.3 Recommended Operating Conditions

	MIN	NOM	MAX	UNIT
Input voltage, VDD	3		20	V
Operating junction temperature, T _J	-20		125	°C

6.4 Thermal Information

THERMAL METRIC ⁽¹⁾		TPS40345	UNIT
		DRC (VSON)	
		10 PINS	
R _{θJA}	Junction-to-ambient thermal resistance	44.3	°C/W
R _{θJC(top)}	Junction-to-case (top) thermal resistance	56.1	°C/W
R _{θJB}	Junction-to-board thermal resistance	19.2	°C/W
Ψ _{JT}	Junction-to-top characterization parameter	0.7	°C/W
Ψ _{JB}	Junction-to-board characterization parameter	19.4	°C/W
R _{θJC(bot)}	Junction-to-case (bottom) thermal resistance	5.5	°C/W

- (1) For more information about traditional and new thermal metrics, see the [Semiconductor and IC Package Thermal Metrics](#) application report.

6.5 Electrical Characteristics

 $T_J = -20^{\circ}\text{C}$ to 125°C , $V_{DD} = 12\text{ V}$, all parameters at zero power dissipation (unless otherwise noted)

PARAMETER		TEST CONDITIONS	MIN	TYP	MAX	UNIT
VOLTAGE REFERENCE						
V_{FB}	FB input voltage	$T_J = 25^{\circ}\text{C}$, $3\text{ V} < V_{DD} < 20\text{ V}$	597	600	603	mV
		$-20^{\circ}\text{C} < T_J < 125^{\circ}\text{C}$, $3\text{ V} < V_{DD} < 20\text{ V}$	592	600	608	
INPUT SUPPLY						
V_{DD}	Input supply voltage range		3		20	V
I_{DDSD}	Shutdown supply current	$V_{EN/SS} < 0.2\text{ V}$		70	100	μA
I_{DDQ}	Quiescent, nonswitching	Let EN/SS float, $V_{FB} = 1\text{ V}$		2.5	3.5	mA
ENABLE/SOFT-START						
V_{IH}	High-level input voltage, EN/SS		0.55	0.7	1	V
V_{IL}	Low-level input voltage, EN/SS		0.27	0.3	0.33	V
I_{SS}	Soft-start source current		8	10	12	μA
V_{SS}	Soft-start voltage level		0.4	0.8	1.3	V
BP REGULATOR						
V_{BP}	Output voltage	$I_{BP} = 10\text{ mA}$	6.2	6.5	6.8	V
V_{DO}	Regulator dropout voltage, $V_{DD} - V_{BP}$	$I_{BP} = 25\text{ mA}$, $V_{DD} = 3\text{ V}$		70	110	mV
OSCILLATOR						
f_{SW}	PWM frequency		540	600	660	kHz
$V_{RAMP}^{(1)}$	Ramp amplitude		$V_{DD}/6.6$	$V_{DD}/6$	$V_{DD}/5.4$	V
f_{SWFSS}	Frequency spread-spectrum frequency deviation		12%			f_{sw}
f_{MOD}	Modulation frequency			25		kHz
PWM						
$D_{MAX}^{(1)}$	Maximum duty cycle	$V_{FB} = 0\text{ V}$, $3\text{ V} < V_{DD} < 20\text{ V}$	90%			
$t_{ON(min)}^{(1)}$	Minimum controllable pulse width				70	ns
t_{DEAD}	Output driver dead time	HDRV off to LDRV on	5	25	35	ns
		LDRV off to HDRV on	5	25	30	
ERROR AMPLIFIER						
$G_{BWP}^{(1)}$	Gain bandwidth product		10	24		MHz
$A_{OL}^{(1)}$	Open loop gain		60			dB
I_{IB}	Input bias current (current out of FB pin)	$V_{FB} = 0.6\text{ V}$			75	nA
I_{EAOP}	Output source current	$V_{FB} = 0\text{ V}$	2			mA
I_{EAOM}	Output sink current	$V_{FB} = 1\text{ V}$	2			
PGOOD						
V_{OV}	Feedback upper voltage limit for PGOOD		655	675	700	mV
V_{UV}	Feedback lower voltage limit for PGOOD		500	525	550	
$V_{PGD-HYST}$	PGOOD hysteresis voltage at FB			25	40	
R_{PGD}	PGOOD pulldown resistance	$V_{FB} = 0\text{ V}$, $I_{FB} = 5\text{ mA}$		30	70	Ω
I_{PGDLK}	PGOOD leakage current	$550\text{ mV} < V_{FB} < 655\text{ mV}$, $V_{PGOOD} = 5\text{ V}$		10	20	μA

(1) Ensured by design. Not production tested.

Electrical Characteristics (continued)
 $T_J = -20^{\circ}\text{C}$ to 125°C , $V_{DD} = 12\text{ V}$, all parameters at zero power dissipation (unless otherwise noted)

PARAMETER		TEST CONDITIONS	MIN	TYP	MAX	UNIT
OUTPUT DRIVERS						
R_{HDHI}	High-side driver pullup resistance	$V_{BOOT} - V_{SW} = 5\text{ V}$, $I_{HDRV} = -100\text{ mA}$	0.8	1.5	2.5	Ω
R_{HDLO}	High-side driver pulldown resistance	$V_{BOOT} - V_{SW} = 5\text{ V}$, $I_{HDRV} = 100\text{ mA}$	0.5	1	2.2	Ω
R_{LDHI}	Low-side driver pullup resistance	$I_{LDRV} = -100\text{ mA}$	0.8	1.5	2.5	Ω
R_{LDLO}	Low-side driver pulldown resistance	$I_{LDRV} = 100\text{ mA}$	0.35	0.6	1.2	Ω
$t_{HRISE}^{(1)}$	High-side driver rise time	$C_{LOAD} = 5\text{ nF}$		15		ns
$t_{HFALL}^{(1)}$	High-side driver fall time			12		ns
$t_{LRISE}^{(1)}$	Low-side driver rise time			15		ns
$t_{LFALL}^{(1)}$	Low-side driver fall time			10		ns
OVERCURRENT PROTECTION						
$t_{PSSC}^{(min)(1)}$	Minimum pulse time during short circuit			250		ns
$t_{BLNKH}^{(1)}$	Switch leading-edge blanking pulse time			150		ns
V_{OCH}	OC threshold for high-side FET	$T_J = 25^{\circ}\text{C}$	360	450	580	mV
I_{OCSET}	OCSET current source	$T_J = 25^{\circ}\text{C}$	9.5	10	10.5	μA
$V_{LD-CLAMP}$	Maximum clamp voltage at LDRV		260	340	400	mV
V_{OCLOS}	OC comparator offset voltage for low-side FET	$T_J = 25^{\circ}\text{C}$	-8		8	mV
$V_{OCLPRO}^{(1)}$	Programmable OC range for low-side FET	$T_J = 25^{\circ}\text{C}$	12		300	mV
$V_{THTC}^{(1)}$	OC threshold temperature coefficient (both high-side and low-side)			3000		ppm
t_{OFF}	OC retry cycles on EN/SS pin			4		Cycle
BOOT DIODE						
V_{DFWD}	Bootstrap diode forward voltage	$I_{BOOT} = 5\text{ mA}$		0.8		V
THERMAL SHUTDOWN						
$T_{JSD}^{(1)}$	Junction shutdown temperature			145		$^{\circ}\text{C}$
$T_{JSDH}^{(1)}$	Hysteresis			20		$^{\circ}\text{C}$

6.6 Typical Characteristics

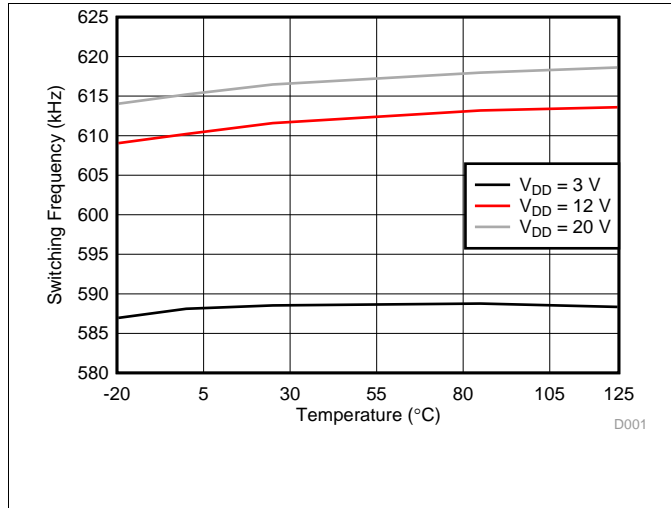

Figure 1. Switching Frequency vs Junction Temperature

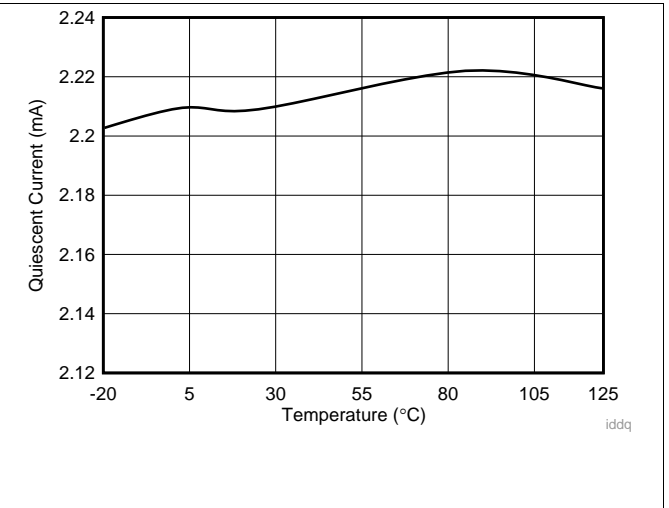

Figure 2. Quiescent Current vs Junction Temperature

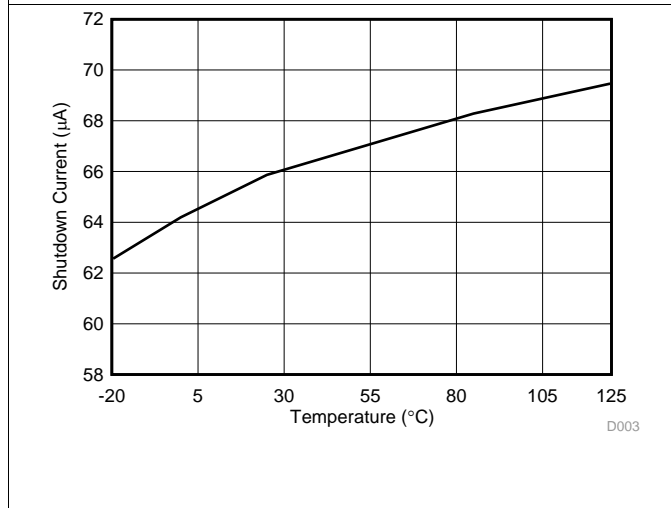

Figure 3. Shutdown Current vs Junction Temperature

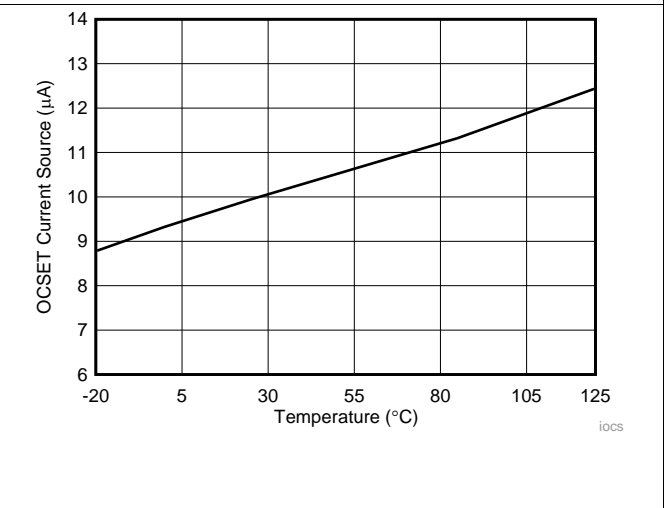

Figure 4. OCSET Current Source vs Junction Temperature

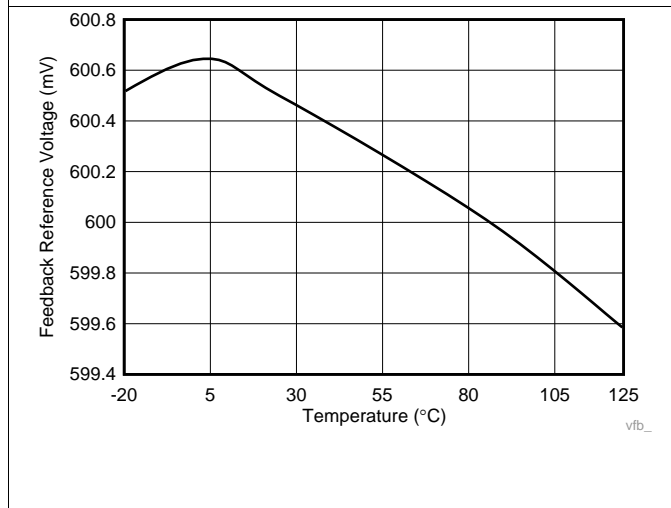

Figure 5. Feedback Reference Voltage vs Junction Temperature

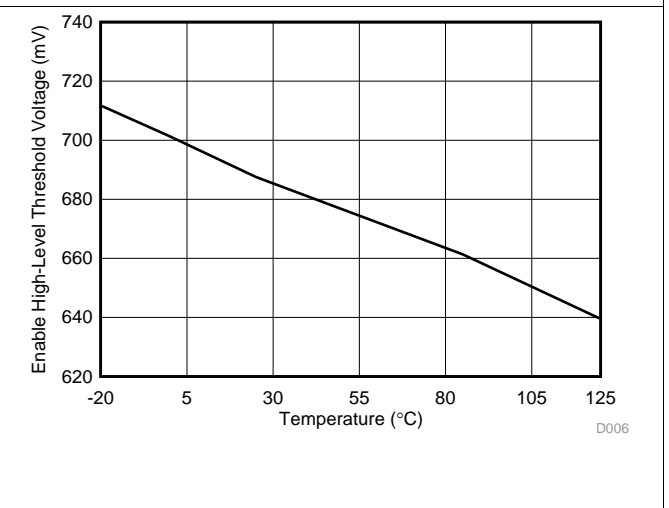

Figure 6. Enable High-Level Threshold Voltage vs Junction Temperature

Typical Characteristics (continued)

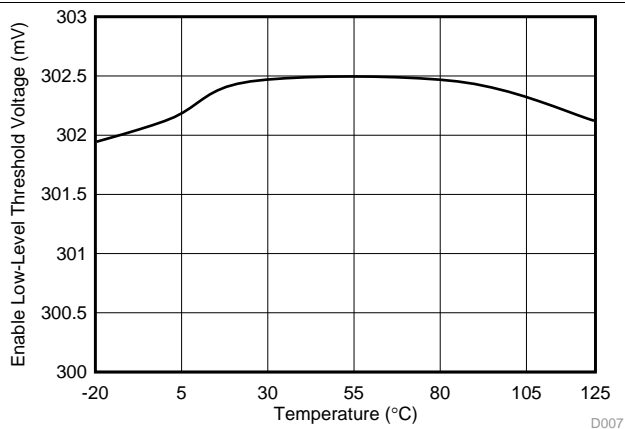

Figure 7. Enable Low-Level Threshold Voltage vs Junction Temperature

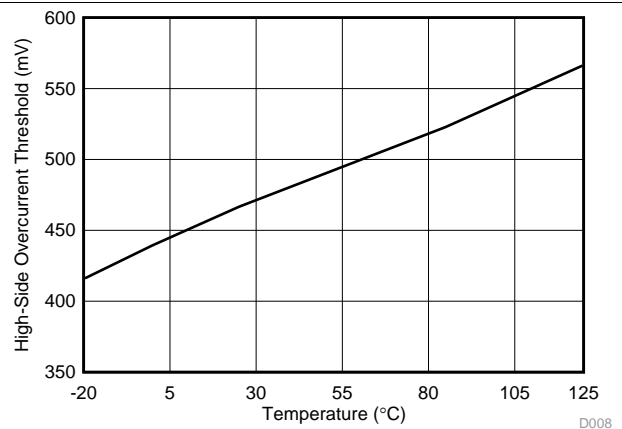

Figure 8. High-Side Overcurrent Threshold vs Junction Temperature

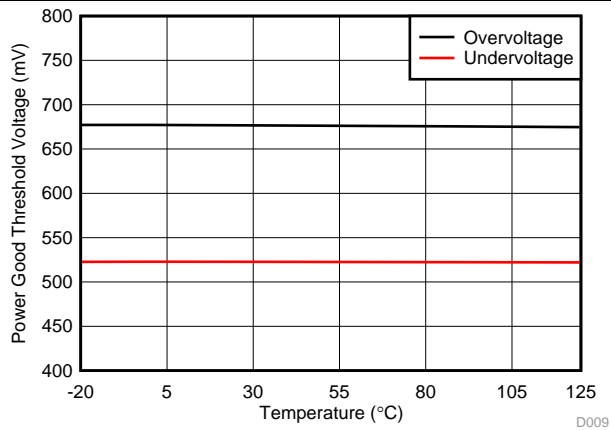

Figure 9. Power Good Threshold Voltage vs Junction Temperature

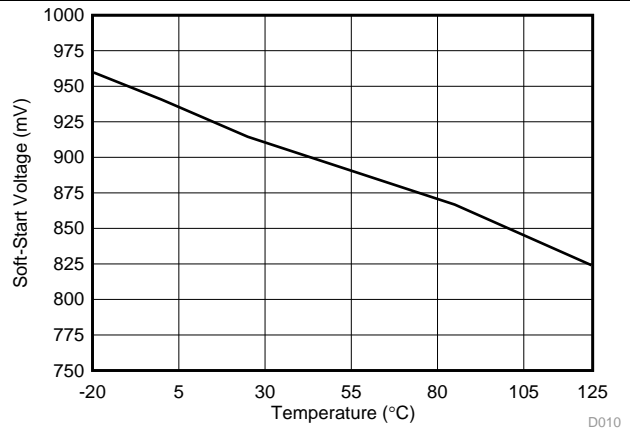

Figure 10. Soft-Start Voltage vs Junction Temperature

7 Detailed Description

7.1 Overview

The TPS40345 is a cost-optimized synchronous buck controller providing high-end features to construct high-performance DC–DC converters. Prebias capability eliminates concerns about damaging sensitive loads during start-up. Programmable overcurrent protection levels and hiccup overcurrent fault recovery maximize design flexibility and minimize power dissipation in the event of a prolonged output short. The frequency spread spectrum (FSS) feature reduces peak EMI noise by spreading the initial energy of each harmonic along a frequency band, thus giving a wider spectrum with lower amplitudes.

7.2 Functional Block Diagram

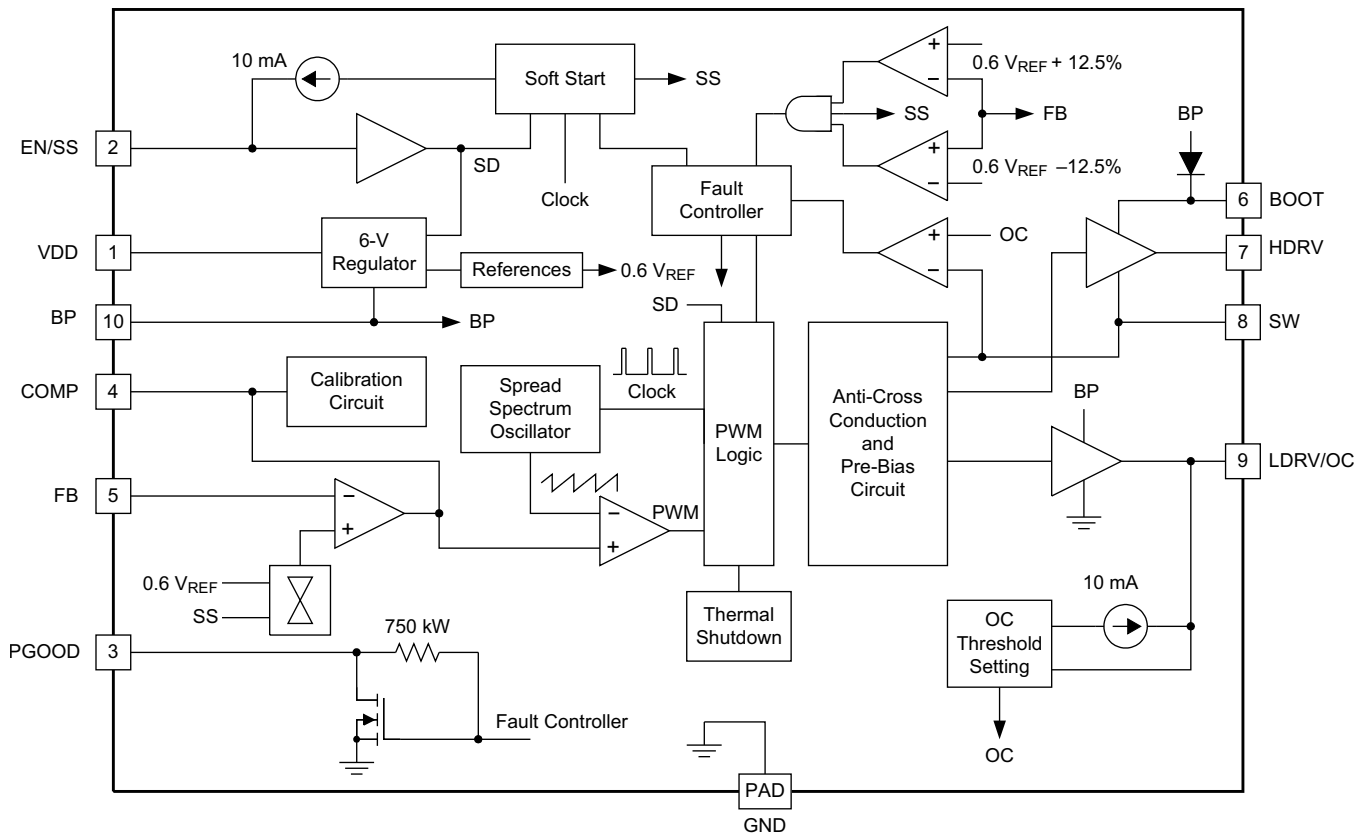

Copyright © 2017, Texas Instruments Incorporated

7.3 Feature Description

7.3.1 Voltage Reference

The 600-mV bandgap cell is internally connected to the noninverting input of the error amplifier. The reference voltage is trimmed with the error amplifier in a unity gain configuration to remove amplifier offset from the final regulation voltage. The 1.3% tolerance on the reference voltage allows the user to design a very accurate power supply.

Feature Description (continued)

7.3.2 Enable Functionality, Start-Up Sequence and Timing

After input power is applied, an internal current source of 40 μA starts to charge up the soft-start capacitor connected from EN/SS to GND. When the voltage across that capacitor increases to 0.7 V, it enables the internal BP regulator followed by a calibration. The total calibration time is about 1.9 ms. See Figure 11. During the calibration, the device performs in the following way. It disables the LDRV drive and injects an internal 10- μA current source to the resistor connected from LDRV to GND. The voltage developed across that resistor is then sampled and latched internally as the OCP trip level until one cycles the input or toggles the EN/SS.

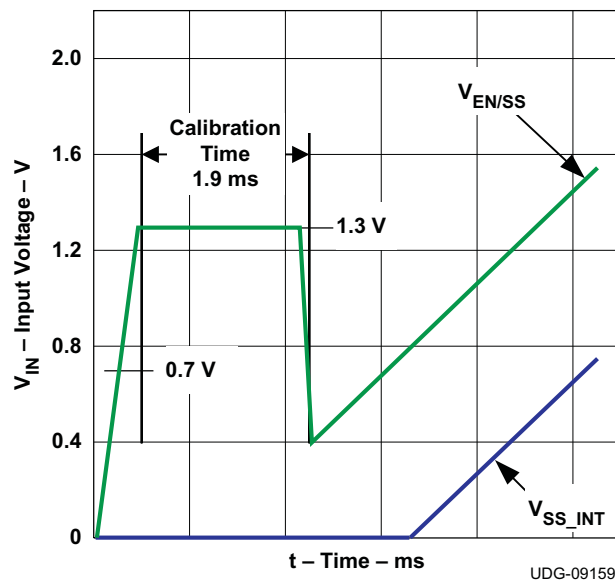

Figure 11. Start-Up Sequence and Timing

The voltage at EN/SS is internally clamped to 1.3 V before and/or during calibration to minimize the discharging time once calibration. The discharging current is from an internal current source of 140 μA and it pulls the voltage down to 0.4 V. The discharging current then initiates the soft-start by charging up the capacitor using an internal current source of 10 μA . The resulting voltage ramp on this pin is used as a second noninverting input to the error amplifier after an 800 mV (typical) downward level-shift; therefore, actual soft-start does not occur until the voltage at this pin reaches 800 mV.

If EN/SS is left floating, the controller starts automatically. EN/SS must be pulled down to less than 270 mV to ensure that the chip is in shutdown mode.

7.3.3 Soft-Start Time

The soft-start time of the TPS40345 is user programmable by selecting a single capacitor. The EN/SS pin sources 10 μA to charge this capacitor. The actual output ramp-up time is the amount of time that it takes for the 10 μA to charge the capacitor through a 600-mV range. There is some initial lag due to calibration and an offset (800 mV) from the actual EN/SS pin voltage to the voltage applied to the error amplifier.

The soft-start is done in a closed-loop fashion, meaning that the error amplifier controls the output voltage at all times during the soft-start period and the feedback loop is never open as occurs in duty cycle limit soft-start schemes. The error amplifier has two non-inverting inputs, one connected to the 600-mV reference voltage, and the other connected to the offset EN/SS pin voltage. The lower of these two voltages is what the error amplifier controls the FB pin. As the voltage on the EN/SS pin ramps up past approximately 1.4 V (800-mV offset voltage plus the 600 mV reference voltage), the 600-mV reference voltage becomes the dominant input and the converter has reached its final regulation voltage.

The capacitor required for a given soft-start ramp time for the output voltage is given by Equation 1.

$$C_{SS} = \left(\frac{I_{SS}}{V_{FB}} \right) \times t_{SS}$$

Feature Description (continued)

where

- C_{SS} is the required capacitance on the EN/SS pin. (F)
 - I_{SS} is the soft-start source current (10 μ A).
 - V_{FB} is the feedback reference voltage (0.6 V).
 - t_{SS} is the desired soft-start ramp time (s).
- (1)

7.3.4 Oscillator and Frequency Spread Spectrum (FSS)

The oscillator frequency is internally fixed. The TPS40345 operating frequency is 600 kHz.

Connecting a resistor with a value of 267 k Ω \pm 10% from BP to EN/SS enables the FSS feature. When the FSS is enabled, it spreads the internal oscillator frequency over a minimum 12% window using a 25-kHz modulation frequency with triangular profile. By modulating the switching frequency, side-bands are created. The emission power of the fundamental switching frequency and its harmonics is distributed into smaller pieces scattered around many sideband frequencies. The effect significantly reduces the peak EMI noise and makes it much easier for the resultant emission spectrum to pass EMI regulations.

7.3.5 Overcurrent Protection

Programmable OCP level at LDRV is from 6 mV to 150 mV at room temperature with 3000 ppm temperature coefficient to help compensate for changes in the low-side FET channel resistance as temperature increases. With a scale factor of 2, the actual trip point across the low-side FET is in the range of 12 mV to 300 mV. The accuracy of the internal current source is \pm 5%. Overall offset voltage, including the offset voltage of the internal comparator and the amplifier for scale factor of 2, is limited to \pm 8 mV.

Maximum clamp voltage at LDRV is 340 mV to avoid turning on the low-side FET during calibration and in a prebiased condition. The maximum clamp voltage is fixed and it does not change with temperature. If the voltage drop across R_{OCSET} reaches the 340-mV maximum clamp voltage during calibration (no R_{OCSET} resistor included), it disables OC protection. Once disabled, there is no low-side or high-side current sensing.

OCP level at HDRV is fixed at 450 mV with 3000-ppm temperature coefficient to help compensate for changes in the high-side FET channel resistance as temperature increases. OCP at HDRV provides pulse-by-pulse current limiting.

OCP sensing at LDRV is a true inductor valley current detection, using sample and hold. Equation 2 can be used to calculate R_{OCSET} :

$$R_{OCSET} = \left(\frac{\left(I_{OUT(max)} - \left(\frac{I_{P-P}}{2} \right) \right) \times R_{DS(on)} - V_{OCLOS}}{2 \times I_{OCSET}} \right)$$

where

- I_{OCSET} is the internal current source.
 - V_{OCLOS} is the overall offset voltage.
 - I_{P-P} is the peak-to-peak inductor current.
 - $R_{DS(on)}$ is the drain to source ON-resistance of the low-side FET.
 - $I_{OUT(max)}$ is the trip point for OCP.
 - R_{OCSET} is the resistor used for setting the OCP level.
- (2)

To avoid overcurrent tripping in normal operating load range, calculate R_{OCSET} using Equation 2 with:

- The maximum $R_{DS(ON)}$ at room temperature
- The lower limit of V_{OCLOS} (–8 mV) and the lower limit of I_{OCSET} (9.5 μ A) from the *Electrical Characteristics* table.
- The peak-to-peak inductor current I_{P-P} at minimum input voltage

Feature Description (continued)

Overcurrent is sensed across both the low-side FET and the high-side FET. If the voltage drop across either FET exceeds the OC threshold, a count increments one count. If no OC is detected on either FET, the fault counter decrements by one count. If three OC pulses are summed, a fault condition is declared which cycles the soft-start function in a hiccup mode. Hiccup mode consists of four dummy soft-start timeouts followed by a real one if overcurrent condition is encountered during normal operation, or five dummy soft-start timeouts followed by a real one if overcurrent condition occurs from the beginning during start. This cycle continues indefinitely until the fault condition is removed.

7.3.6 Drivers

The drivers for the external high-side and low-side MOSFETs can drive a gate-to-source voltage of V_{BP} . The LDRV driver for the low-side MOSFET switches between BP and GND, while the HDRV driver for the high-side MOSFET is referenced to SW and switches between BOOT and SW. The drivers have nonoverlapping timing that is governed by an adaptive delay circuit to minimize body diode conduction in the synchronous rectifier.

7.3.7 Prebias Start-Up

The TPS40345 contains a circuit to prevent current from being pulled from the output during start-up in the condition the output is prebiased. There are no PWM pulses until the internal soft-start voltage rises above the error amplifier input (FB pin), if the output is prebiased. Once the soft-start voltage exceeds the error amplifier input, the controller slowly initiates synchronous rectification by starting the synchronous rectifier with a narrow on time. The controller then increments that on time on a cycle-by-cycle basis until it coincides with the time dictated by $(1-D)$, where D is the duty cycle of the converter. This approach prevents the sinking of current from a prebiased output, and ensures the output voltage start-up and ramp to regulation is smooth and controlled.

7.3.8 Power Good

The TPS40345 provides an indication that output is good for the converter. This is an open-drain signal and pulls low when any condition exists that would indicate that the output of the supply might be out of regulation. These conditions include the following:

- V_{FB} is more than $\pm 12.5\%$ from nominal.
- Soft-start is active.
- A short-circuit condition has been detected.

NOTE

When there is no power to the device, PGOOD is not able to pull close to GND if an auxiliary supply is used for the power good indication. In this case, a built-in resistor connected from drain to gate on the PGOOD pulldown device makes the PGOOD pin look approximately like a diode to GND.

7.3.9 Thermal Shutdown

If the junction temperature of the device reaches the thermal shutdown limit of 145°C , the PWM and the oscillator are turned off and HDRV and LDRV are driven low. When the junction cools to the required level (125°C typical), the PWM initiates soft-start as during a normal power-up cycle.

7.4 Device Functional Modes

7.4.1 Modes of Operation

7.4.1.1 UVLO

In UVLO, VDD is less than UVLO_ON, the BP6 regulator is off, and the HDRV and LDRV are held low by internal passive discharge resistors.

7.4.1.2 Disable

Disable is forced by holding SS/EN below 0.4 V. In disable, the BP6 regulator is off, and both HDRV and LDRV are held low by passive discharge resistors.

Device Functional Modes (continued)

7.4.1.3 Calibration

Each enable of the TPS40345 device requires a calibration which lasts approximately 2 ms. During calibration the TPS40345 device LDRV and HDRV are held off by its pulldown drivers while the device configures as detailed in [Enable Functionality, Start-Up Sequence and Timing](#).

7.4.1.4 Converting

When calibration completes, the TPS40345 ramps its reference voltage as described in [Soft-Start Time](#), and the states of the LDRV and HDRV drivers are dictated by the COMP pin to regulate the FB pin equal to the internal reference.

8 Application and Implementation

NOTE

Information in the following applications sections is not part of the TI component specification, and TI does not warrant its accuracy or completeness. TI's customers are responsible for determining suitability of components for their purposes. Customers should validate and test their design implementation to confirm system functionality.

8.1 Application Information

The TPS40345 is a cost-optimized synchronous buck controllers providing high-end features to construct high-performance DC-DC converters. Prebias capability eliminates concerns about damaging sensitive loads during start-up. Programmable overcurrent protection levels and hiccup overcurrent fault recovery maximize design flexibility and minimize power dissipation in the event of a prolonged output short. Frequency spread spectrum (FSS) feature reduces peak EMI noise by spreading the initial energy of each harmonic along a frequency band, thus giving a wider spectrum with lower amplitudes.

8.2 Typical Applications

For this 20-A, 12-V to 1.2-V design, the 600-kHz TPS40345 was selected for a balance between small size and high efficiency.

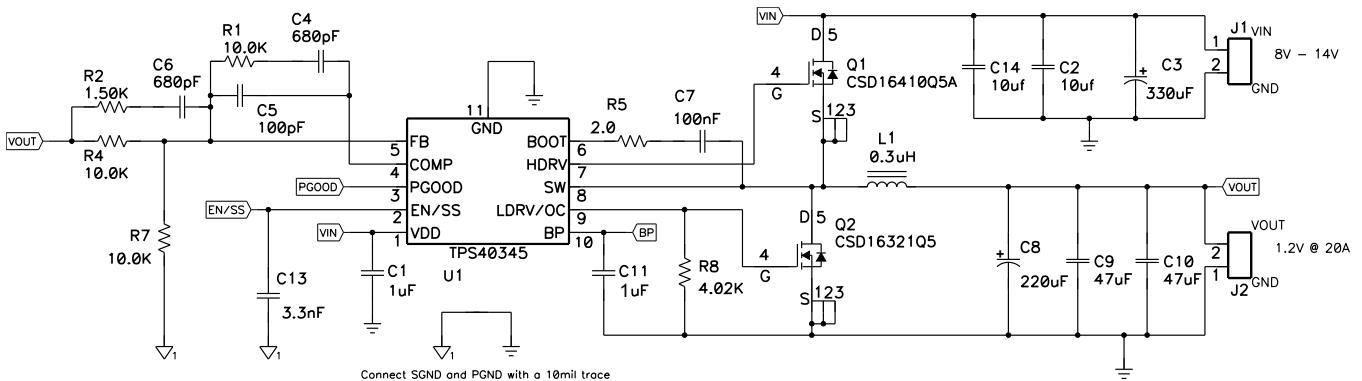

Figure 12. TPS40345 Design Example Schematic

Typical Applications (continued)

8.2.1 Design Requirements

For this example, follow the design parameters listed in [Table 1](#).

Table 1. Design Example Electrical Characteristics

PARAMETER		TEST CONDITIONS	MIN	TYP	MAX	UNIT
V _{IN}	Input voltage		8		14	V
V _{INripple}	Input ripple	I _{OUT} = 20 A			0.5	V
V _{OUT}	Output voltage	0 A ≤ I _{OUT} ≤ 20 A	1.164	1.2	1.236	V
	Line regulation	8 V ≤ V _{IN} ≤ 14 V			0.5%	
	Load regulation	0 A ≤ I _{OUT} ≤ 20 A			0.5%	
V _{RIPPLE}	Output ripple	I _{OUT} = 20 A			36	mV
V _{OVER}	Output overshoot	5 A ≤ I _{OUT} ≤ 15 A		100		mV
V _{UNDER}	Output undershoot	5 A ≤ I _{OUT} ≤ 15 A		100		mV
I _{OUT}	Output current	8 V ≤ V _{IN} ≤ 14 V	0		20	A
t _{SS}	Soft-start time	V _{IN} = 12 V		1.5		ms
I _{SCP}	Short-circuit current trip point		26			A
f _{SW}	Switching frequency			600		kHz
	Size				1.5	in ²

8.2.2 Detailed Design Procedure

8.2.2.1 Selecting the Switching Frequency

To achieve the small size for this design the TPS40345, with $f_{SW} = 600$ kHz, is selected for minimal external component size.

8.2.2.2 Inductor Selection (L1)

Synchronous buck power inductors are typically sized for approximately 30% peak-to-peak ripple current (I_{RIPPLE}).

Given this target ripple current, the required inductor size can be calculated in [Equation 3](#).

$$L \approx \frac{V_{IN(max)} - V_{OUT}}{0.3 \times I_{OUT}} \times \frac{V_{OUT}}{V_{IN(max)}} \times \frac{1}{F_{SW}} = \frac{14V - 1.2V}{0.3 \times 20A} \times \frac{1.2V}{14V} \times \frac{1}{600kHz} = 305nH \quad (3)$$

Selecting a standard 300-nH inductor value, solve for I_{RIPPLE} = 6 A

The RMS current through the inductor is approximated by [Equation 4](#).

$$I_{Lrms} = \sqrt{I_{Lavg}^2 + \frac{1}{12} I_{RIPPLE}^2} = \sqrt{I_{OUT}^2 + \frac{1}{12} I_{RIPPLE}^2} = \sqrt{20^2 + \frac{1}{12} 6^2} = 20.07 A \quad (4)$$

8.2.2.3 Output Capacitor Selection (C12)

The selection of the output capacitor is typically driven by the output transient response. [Equation 5](#) and [Equation 6](#) overestimate the voltage deviation to account for delays in the loop bandwidth and can be used to determine the required output capacitance.

$$V_{OVER} < \frac{I_{TRAN}}{C_{OUT}} \times \Delta T = \frac{I_{TRAN}}{C_{OUT}} \times \frac{I_{TRAN} \times L}{V_{OUT}} = \frac{I_{TRAN}^2 \times L}{V_{OUT} \times C_{OUT}} \quad (5)$$

$$V_{UNDER} < \frac{I_{TRAN}}{C_{OUT}} \times \Delta T = \frac{I_{TRAN}}{C_{OUT}} \times \frac{I_{TRAN} \times L}{V_{IN} - V_{OUT}} = \frac{I_{TRAN}^2 \times L}{(V_{IN} - V_{OUT}) \times C_{OUT}} \quad (6)$$

If $V_{IN(min)} > 2 \times V_{OUT}$, use overshoot ([Equation 5](#)) to calculate minimum output capacitance. If $V_{IN(min)} < 2 \times V_{OUT}$, use undershoot ([Equation 6](#)) to calculate minimum output capacitance.

$$C_{OUT(MIN)} = \frac{I_{TRAN(MAX)}^2 \times L}{(V_{OUT}) \times V_{OVER}} = \frac{10^2 \times 300nH}{1.2 \times 100mV} = 250\mu F \quad (7)$$

With a minimum capacitance, the maximum allowable ESR is determined by the maximum ripple voltage and is approximated by [Equation 8](#).

$$ESR_{max} = \frac{V_{RIPPLE(Total)} - V_{RIPPLE(CAP)}}{I_{RIPPLE}} = \frac{V_{RIPPLE(total)} - \left(\frac{I_{RIPPLE}}{8 \times C_{OUT} \times F_{SW}} \right)}{I_{RIPPLE}} = \frac{36mV - \left(\frac{6A}{8 \times 250\mu F \times 600kHz} \right)}{6A} = 5.2m\Omega \quad (8)$$

Two 47- μ F and one 220- μ F capacitors are selected to provide more than 250 μ F of minimum capacitance and 5.2 m Ω of ESR.

8.2.2.4 Peak Current Rating of Inductor

With output capacitance, it is possible to calculate the charge current during start-up and determine the minimum saturation current rating for the inductor. The start-up charging current is approximated by [Equation 9](#).

$$I_{CHARGE} = \frac{V_{OUT} \times C_{OUT}}{T_{SS}} = \frac{1.2V(2 \times 47\mu F + 220\mu F)}{1.5ms} = 0.251A \quad (9)$$

$$I_{L_PEAK} = I_{OUT(max)} + \frac{1}{2} I_{RIPPLE} + I_{CHARGE} = 20A + \frac{1}{2} \times 6A + 0.2512A = 23.25A \quad (10)$$

Table 2. Inductor Requirements

PARAMETER		VALUE	UNIT
L	Inductance	300	nH
$I_{L(rms)}$	RMS current (thermal rating)	20.07	A
$I_{L(peak)}$	Peak current (saturation rating)	23.25	A

8.2.2.5 Input Capacitor Selection (C8)

The input voltage ripple is divided between capacitance and ESR. For this design $V_{RIPPLE(cap)} = 150$ mV and $V_{RIPPLE(esr)} = 150$ mV. The minimum capacitance and maximum ESR are estimated by [Equation 11](#).

$$C_{IN(min)} = \frac{I_{LOAD} \times V_{OUT}}{V_{RIPPLE(CAP)} \times V_{IN} \times F_{SW}} = \frac{20 \times 1.2V}{150mV \times 8V \times 600kHz} = 33.3\mu F \quad (11)$$

$$ESR_{MAX} = \frac{V_{RIPPLE(ESR)}}{I_{LOAD} + \frac{1}{2} I_{RIPPLE}} = \frac{150mV}{23A} = 6.5m\Omega \quad (12)$$

The RMS current in the input capacitors is estimated by [Equation 13](#).

$$I_{RMS_CIN} = I_{LOAD} \times \sqrt{D \times (1-D)} = 20A \times \sqrt{0.15 \times (1-0.15)} = 7.14 Arms \quad (13)$$

Three 1210, 10- μ F, 25-V, X5R ceramic capacitors are selected. Higher voltage capacitors are selected to minimize capacitance loss at the DC bias voltage to ensure the capacitors allow sufficient capacitance at the working voltage.

8.2.2.6 MOSFET Switch Selection (Q1 and Q2)

Reviewing available TI NexFET MOSFETs using the TI NexFET MOSFET selection tool, the CSD16410Q5A and CSD16321Q5 5-mm \times 6-mm MOSFETs are selected.

These two FETs have maximum total gate charges of 5 nC and 10 nC, respectively.

8.2.2.7 Bootstrap Capacitor (C6)

To ensure proper charging of the high-side FET gate, limit the ripple voltage on the boost capacitor to less than 50 mV.

$$C_{Boost} = 20 \times Q_{G1} = 20 \times 5nC = 100nF \quad (14)$$

8.2.2.8 VDD Bypass Capacitor (C7)

Per this TPS40345 data sheet, select a 1-uF X5R or better ceramic bypass capacitor for VDD.

8.2.2.9 BP Bypass Capacitor (C5)

Per the TPS40345 data sheet, a minimum 1-uF ceramic capacitance is required to stabilize the BP regulator. To limit regulator noise to less than 10 mV, the value of the bypass capacitor is calculated in Equation 15.

$$C_{BP} = 100 \times \text{MAX}(Q_{G1}, Q_{G2}) \quad (15)$$

Because Q2 is larger than Q1, and the total gate charge of Q2 is 10 nC, a BP capacitor of 1 μF is calculated. A standard value of 1 μF is selected to limit noise on the BP regulator.

8.2.2.10 Short-Circuit Protection (R11)

The TPS40345 uses the negative drop across the low-side FET at the end of the OFF-time to measure the inductor current. Allowing for 30% over maximum load and 20% rise in $R_{DS(on)Q1}$ for self-heating, the voltage drop across the low-side FET at current limit is given by Equation 16.

$$V_{OC} = (1.3 \times I_{LOAD} - \frac{1}{2} I_{ripple}) \times 1.2 \times R_{DS(on)Q2} = (1.3 \times 20 \text{ A} - \frac{1}{2} 6 \text{ A}) \times 1.2 \times 4.6 \text{ m}\Omega = 127 \text{ mV} \quad (16)$$

The TPS40345 internal temperature coefficient helps compensate for the MOSFET's $R_{DS(on)}$ temperature coefficient, so the current limit programming resistor is selected by Equation 17.

$$R_{CS} = \frac{V_{OC} - V_{OCLOS(min)}}{2 \times I_{OCSET(min)}} = \frac{127 \text{ mV} - (-8 \text{ mV})}{2 \times 9.5 \text{ }\mu\text{A}} = 7.1 \text{ k}\Omega \quad (17)$$

8.2.2.11 Feedback Divider (R4, R5)

The TPS40345 controller uses a full operational amplifier with an internally fixed 0.6-V reference. R4 is selected between 10 kΩ and 50 kΩ for a balance of feedback current and noise immunity. With R4 set to 10 kΩ, The output voltage is programmed with a resistor divider given by Equation 18.

$$R7 = \frac{V_{FB} \times R4}{V_{OUT} - V_{FB}} = \frac{0.600 \text{ V} \times 10.0 \text{ k}\Omega}{1.2 \text{ V} - 0.600 \text{ V}} = 10 \text{ k}\Omega \quad (18)$$

8.2.2.12 Compensation: (C2, C3, C4, R3, R6)

Using the TPS40k Loop Stability Tool for 100-kHz bandwidth and 60° phase margin with a R4 value of 10.0 kΩ, the following values are returned.

- C4 = 680 pF
- C5 = 100 pF
- C6 = 680 pF
- R1 = 10 kΩ
- R2 = 1.5 kΩ

8.2.3 Application Curves

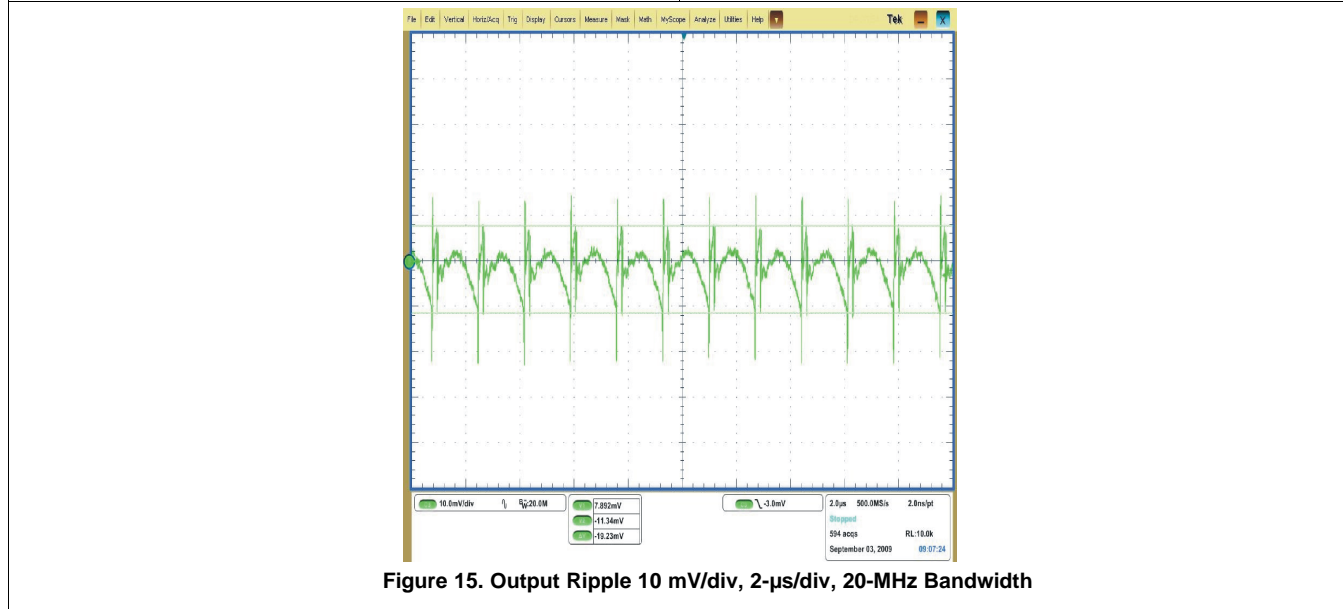
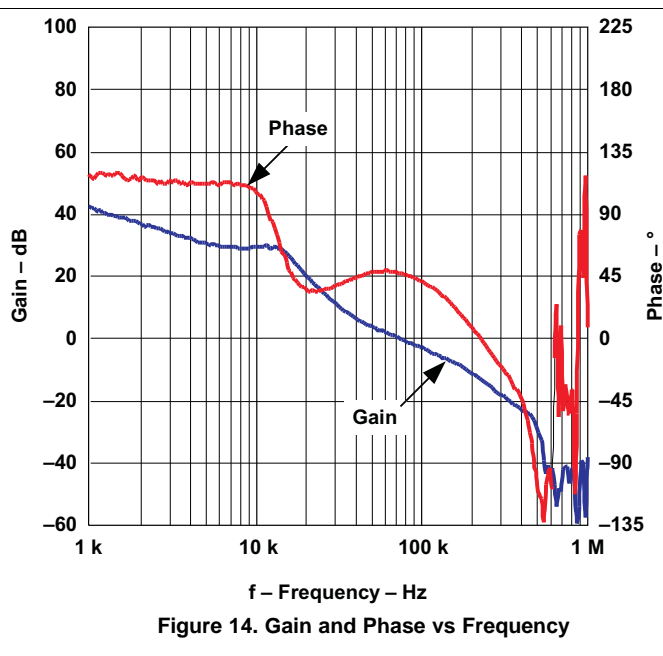
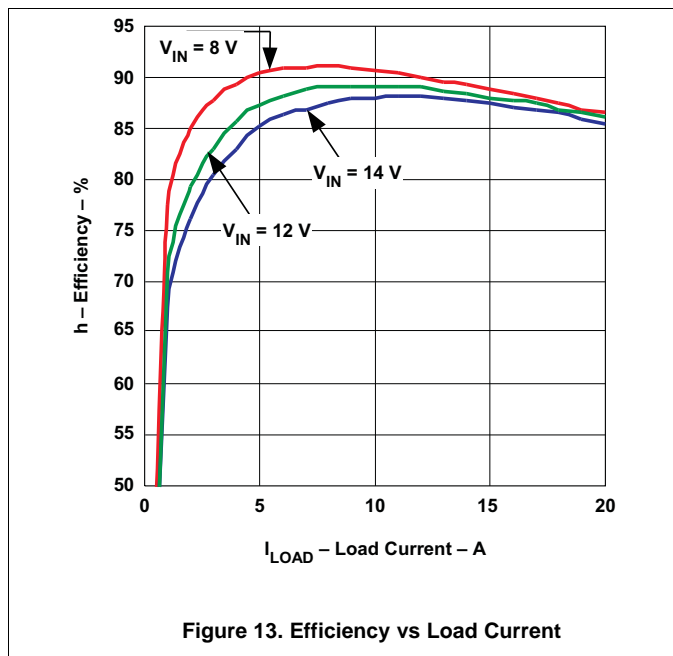

9 Power Supply Recommendations

The TPS40345 device is designed to operate from an input voltage supply between 3 V and 20 V. This input supply must remain within the input voltage supply range. This supply must be well regulated.

10 Layout

10.1 Layout Guidelines

- For MOSFET or power block layout, follow the layout recommendations provided for the MOSFET or power block selected.
- Connect VDD to VIN as close as possible to the drain connection of the high-side FET to avoid introducing additional drop, which could trigger short-circuit protection.
- Place VDD and BP to GND capacitors within 2 mm of the device and connected to the thermal pad (GND).
- Connect the FB to GND resistor to the thermal tab (GND) with a minimum 10-mil wide trace.
- Place VOUT to FB resistor within 2 mm of the FB pin.
- Connect the EN/SS-to-GND capacitor to the thermal tab (GND) with a minimum 10-mil-wide trace. It may share this trace with FB to GND.
- If a BJT or MOSFET is used to disable EN/SS, place it within 5 mm of the device.
- If a COMP to GND resistor is used, place it within 5 mm of the device.
- All COMP and FB traces should be kept minimum line width and as short as possible to minimize noise coupling.
- EN/SS should not be routed more than 20 mm from the device.
- If multiple layers are used, extend GND under all components connected to FB, COMP and EN/SS to reduce noise sensitivity.
- HDRV and LDRV must provide short, low inductance paths of 5 mm or less to the gates of the MOSFETs or power block.
- Place no more than 1 Ω of resistance between HDRV or LDRV and their MOSFET or power block gate pins.
- LDRV / OC to GND current limit programming resistor may be placed on the far side of the MOSFET if necessary to ensure a short connection from LDRV to the gate of the low-side MOSFET.
- Place the BOOT to SW resistor and capacitor within 4 mm of the device using a minimum of 10-mil-wide trace. The full width of the component pads are preferred for trace widths if design rules allow.
- If via must be used between the HDRV, SW and LDRV pins and their respective MOSFET or power block connections, use a minimum of two vias to reduce parasitic inductance
- Refer to the land pattern data for the preferred layout of thermal vias within the thermal pad.
- TI recommends extending the top-layer copper area of the thermal pad (GND) beyond the package a minimum 3 mm between pins 1 and 10 and 5 and 6 to improve thermal resistance to ambient of the device.

10.2 Layout Example

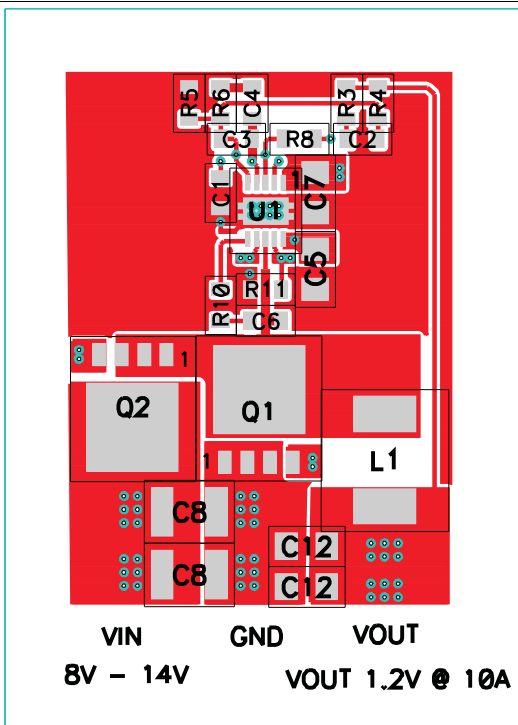

Figure 16. Top Copper With Components

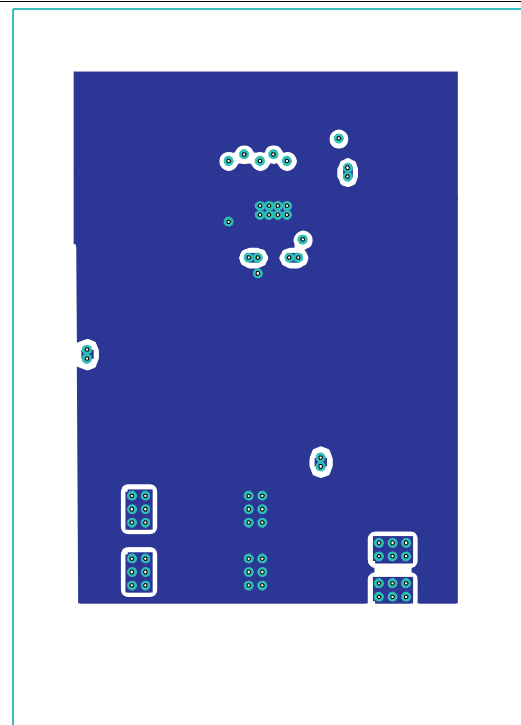

Figure 17. Top Internal Copper Layout

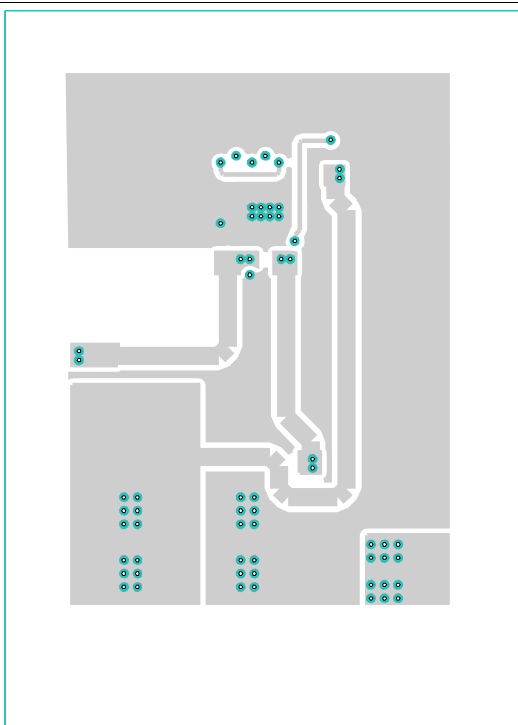

Figure 18. Bottom Internal Copper Layout

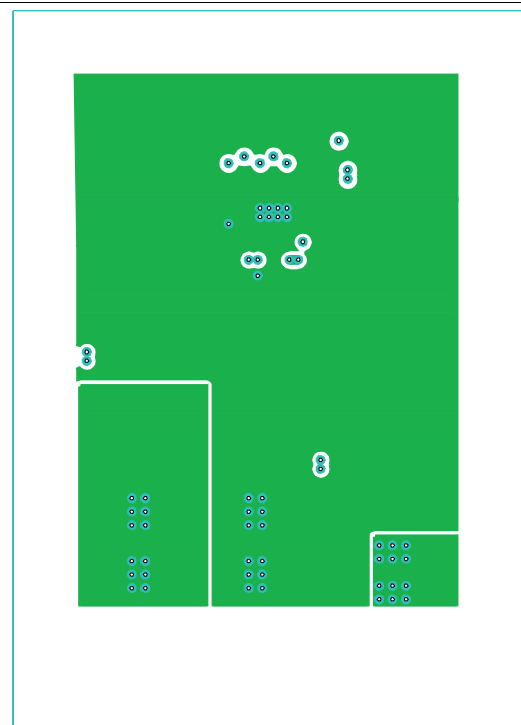

Figure 19. Bottom Copper Layer

11 器件和文档支持

11.1 器件支持

11.1.1 Third-Party Products Disclaimer

TI'S PUBLICATION OF INFORMATION REGARDING THIRD-PARTY PRODUCTS OR SERVICES DOES NOT CONSTITUTE AN ENDORSEMENT REGARDING THE SUITABILITY OF SUCH PRODUCTS OR SERVICES OR A WARRANTY, REPRESENTATION OR ENDORSEMENT OF SUCH PRODUCTS OR SERVICES, EITHER ALONE OR IN COMBINATION WITH ANY TI PRODUCT OR SERVICE.

11.2 文档支持

11.2.1 相关文档

这些参考资料、设计工具以及附加参考资料的链接（包括设计软件）均可在 <http://power.ti.com> 网站上找到

1. 更多 PowerPAD™ 信息可在 应用 简介 (SLMA002) 和 (SLMA004) 中找到。
2. [了解开关模式电源中的降压功率级](#)
3. 《低电压直流/直流转换器内部探究》– SEM1500 主题 5 – 2002 年研讨会系列
4. 《设计稳定控制环路》– SEM 1400 – 2001 年研讨会系列

11.3 接收文档更新通知

要接收文档更新通知，请导航至 TI.com 上的器件产品文件夹。单击右上角的 [通知我](#) 进行注册，即可每周接收产品信息更改摘要。有关更改的详细信息，请查看任何已修订文档中包含的修订历史记录。

11.4 社区资源

下列链接提供到 TI 社区资源的连接。链接的内容由各个分销商“按照原样”提供。这些内容并不构成 TI 技术规范，并且不一定反映 TI 的观点；请参阅 TI 的 [《使用条款》](#)。

TI E2E™ 在线社区 [TI 的工程师对工程师 \(E2E\) 社区](#)。此社区的创建目的在于促进工程师之间的协作。在 e2e.ti.com 中，您可以咨询问题、分享知识、拓展思路并与同行工程师一道帮助解决问题。

设计支持 [TI 参考设计支持](#) 可帮助您快速查找有帮助的 E2E 论坛、设计支持工具以及技术支持的联系信息。

11.5 商标

E2E is a trademark of Texas Instruments.
All other trademarks are the property of their respective owners.

11.6 静电放电警告



这些装置包含有限的内置 ESD 保护。存储或装卸时，应将导线一起截短或将装置放置于导电泡棉中，以防止 MOS 门极遭受静电损伤。

11.7 Glossary

[SLYZ022](#) — *TI Glossary*.

This glossary lists and explains terms, acronyms, and definitions.

12 机械、封装和可订购信息

以下页面包含机械、封装和可订购信息。这些信息是指定器件的最新可用数据。数据如有变更，恕不另行通知和修订此文档。如欲获取此数据表的浏览器版本，请参阅左侧的导航。

PACKAGING INFORMATION

Orderable Device	Status (1)	Package Type	Package Drawing	Pins	Package Qty	Eco Plan (2)	Lead finish/ Ball material (6)	MSL Peak Temp (3)	Op Temp (°C)	Device Marking (4/5)	Samples
TPS40345DRCR	ACTIVE	VSON	DRC	10	3000	RoHS & Green	NIPDAUAG	Level-2-260C-1 YEAR	-20 to 85	0345	Samples
TPS40345DRCT	ACTIVE	VSON	DRC	10	250	RoHS & Green	NIPDAUAG	Level-2-260C-1 YEAR	-20 to 85	0345	Samples

(1) The marketing status values are defined as follows:

ACTIVE: Product device recommended for new designs.

LIFEBUY: TI has announced that the device will be discontinued, and a lifetime-buy period is in effect.

NRND: Not recommended for new designs. Device is in production to support existing customers, but TI does not recommend using this part in a new design.

PREVIEW: Device has been announced but is not in production. Samples may or may not be available.

OBSOLETE: TI has discontinued the production of the device.

(2) **RoHS:** TI defines "RoHS" to mean semiconductor products that are compliant with the current EU RoHS requirements for all 10 RoHS substances, including the requirement that RoHS substance do not exceed 0.1% by weight in homogeneous materials. Where designed to be soldered at high temperatures, "RoHS" products are suitable for use in specified lead-free processes. TI may reference these types of products as "Pb-Free".

RoHS Exempt: TI defines "RoHS Exempt" to mean products that contain lead but are compliant with EU RoHS pursuant to a specific EU RoHS exemption.

Green: TI defines "Green" to mean the content of Chlorine (Cl) and Bromine (Br) based flame retardants meet JS709B low halogen requirements of <=1000ppm threshold. Antimony trioxide based flame retardants must also meet the <=1000ppm threshold requirement.

(3) MSL, Peak Temp. - The Moisture Sensitivity Level rating according to the JEDEC industry standard classifications, and peak solder temperature.

(4) There may be additional marking, which relates to the logo, the lot trace code information, or the environmental category on the device.

(5) Multiple Device Markings will be inside parentheses. Only one Device Marking contained in parentheses and separated by a "~" will appear on a device. If a line is indented then it is a continuation of the previous line and the two combined represent the entire Device Marking for that device.

(6) Lead finish/Ball material - Orderable Devices may have multiple material finish options. Finish options are separated by a vertical ruled line. Lead finish/Ball material values may wrap to two lines if the finish value exceeds the maximum column width.

Important Information and Disclaimer:The information provided on this page represents TI's knowledge and belief as of the date that it is provided. TI bases its knowledge and belief on information provided by third parties, and makes no representation or warranty as to the accuracy of such information. Efforts are underway to better integrate information from third parties. TI has taken and continues to take reasonable steps to provide representative and accurate information but may not have conducted destructive testing or chemical analysis on incoming materials and chemicals. TI and TI suppliers consider certain information to be proprietary, and thus CAS numbers and other limited information may not be available for release.

In no event shall TI's liability arising out of such information exceed the total purchase price of the TI part(s) at issue in this document sold by TI to Customer on an annual basis.

TAPE AND REEL INFORMATION

QUADRANT ASSIGNMENTS FOR PIN 1 ORIENTATION IN TAPE

*All dimensions are nominal

Device	Package Type	Package Drawing	Pins	SPQ	Reel Diameter (mm)	Reel Width W1 (mm)	A0 (mm)	B0 (mm)	K0 (mm)	P1 (mm)	W (mm)	Pin1 Quadrant
TPS40345DRCR	VSON	DRC	10	3000	330.0	12.4	3.3	3.3	1.1	8.0	12.0	Q2
TPS40345DRCT	VSON	DRC	10	250	180.0	12.5	3.3	3.3	1.1	8.0	12.0	Q2

TAPE AND REEL BOX DIMENSIONS

*All dimensions are nominal

Device	Package Type	Package Drawing	Pins	SPQ	Length (mm)	Width (mm)	Height (mm)
TPS40345DRCR	VSON	DRC	10	3000	338.0	355.0	50.0
TPS40345DRCT	VSON	DRC	10	250	205.0	200.0	33.0

GENERIC PACKAGE VIEW

DRC 10

VSON - 1 mm max height

3 x 3, 0.5 mm pitch

PLASTIC SMALL OUTLINE - NO LEAD

This image is a representation of the package family, actual package may vary.
Refer to the product data sheet for package details.

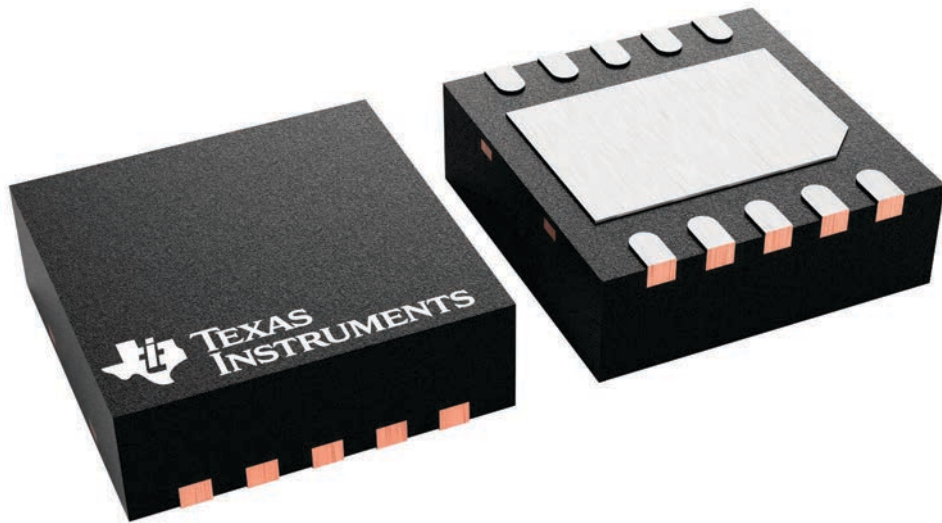

4226193/A

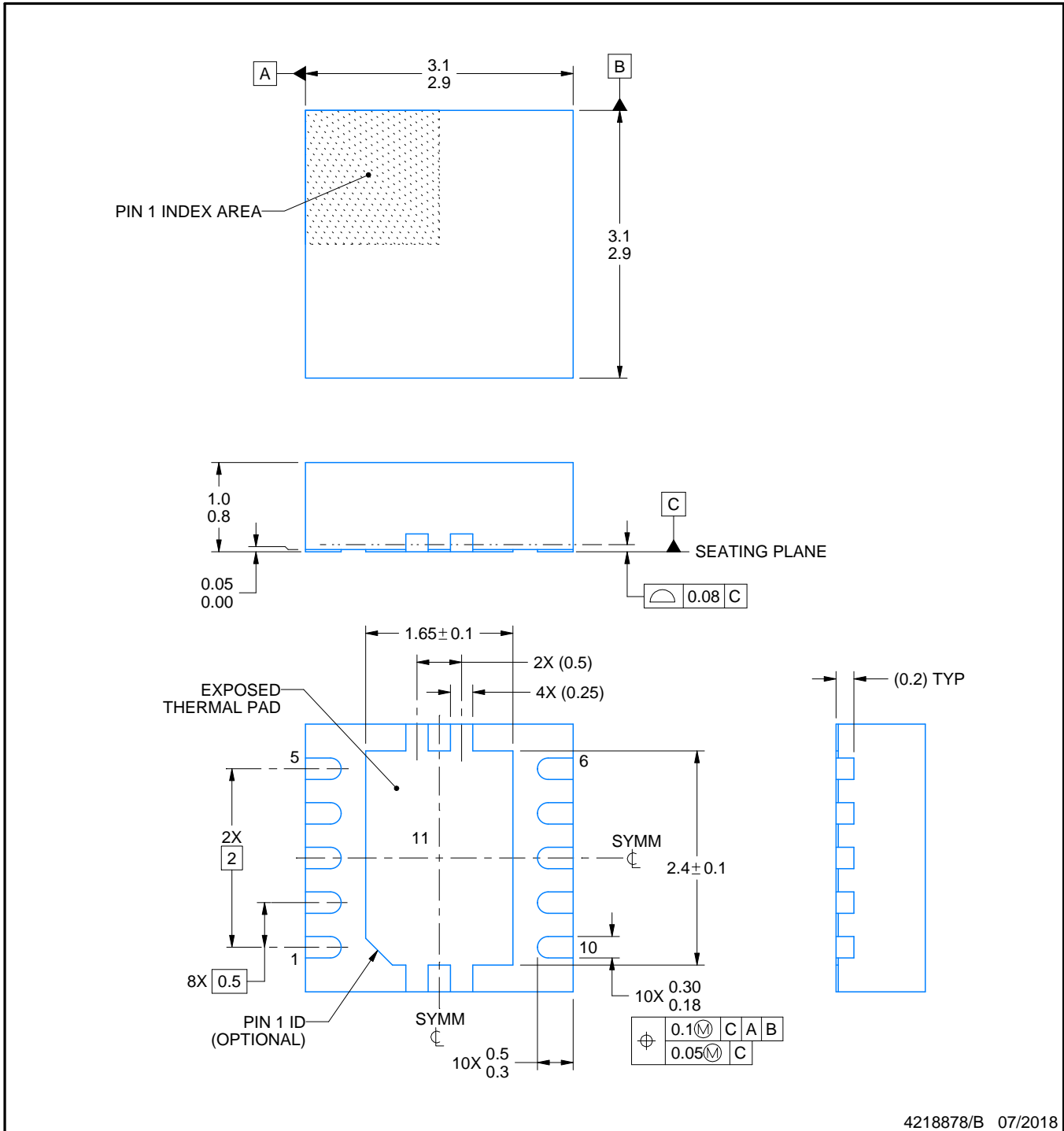

4218878/B 07/2018

NOTES:

1. All linear dimensions are in millimeters. Any dimensions in parenthesis are for reference only. Dimensioning and tolerancing per ASME Y14.5M.
2. This drawing is subject to change without notice.
3. The package thermal pad must be soldered to the printed circuit board for optimal thermal and mechanical performance.

EXAMPLE BOARD LAYOUT

DRC0010J

VSON - 1 mm max height

PLASTIC SMALL OUTLINE - NO LEAD

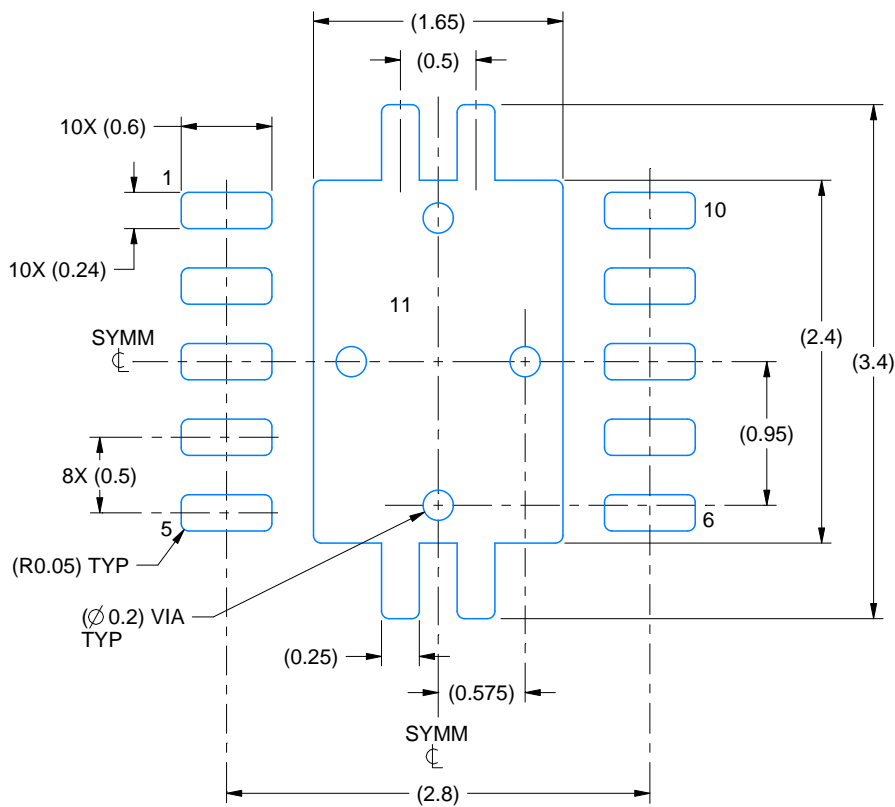

LAND PATTERN EXAMPLE
EXPOSED METAL SHOWN
SCALE:20X

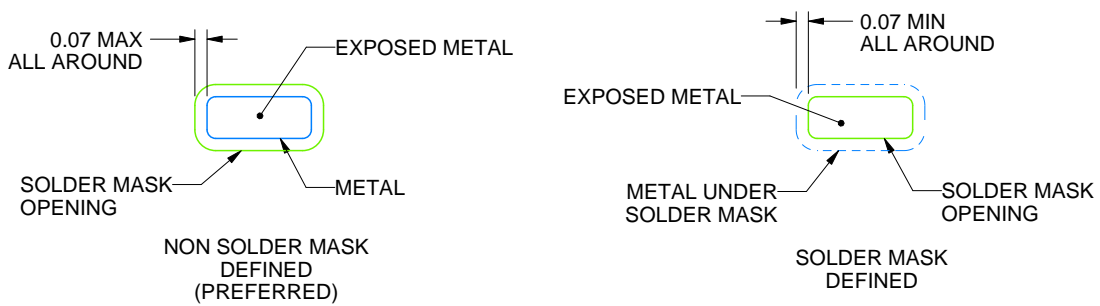

SOLDER MASK DETAILS

4218878/B 07/2018

NOTES: (continued)

4. This package is designed to be soldered to a thermal pad on the board. For more information, see Texas Instruments literature number SLUA271 (www.ti.com/lit/sluea271).
5. Vias are optional depending on application, refer to device data sheet. If any vias are implemented, refer to their locations shown on this view. It is recommended that vias under paste be filled, plugged or tented.

EXAMPLE STENCIL DESIGN

DRC0010J

VSON - 1 mm max height

PLASTIC SMALL OUTLINE - NO LEAD

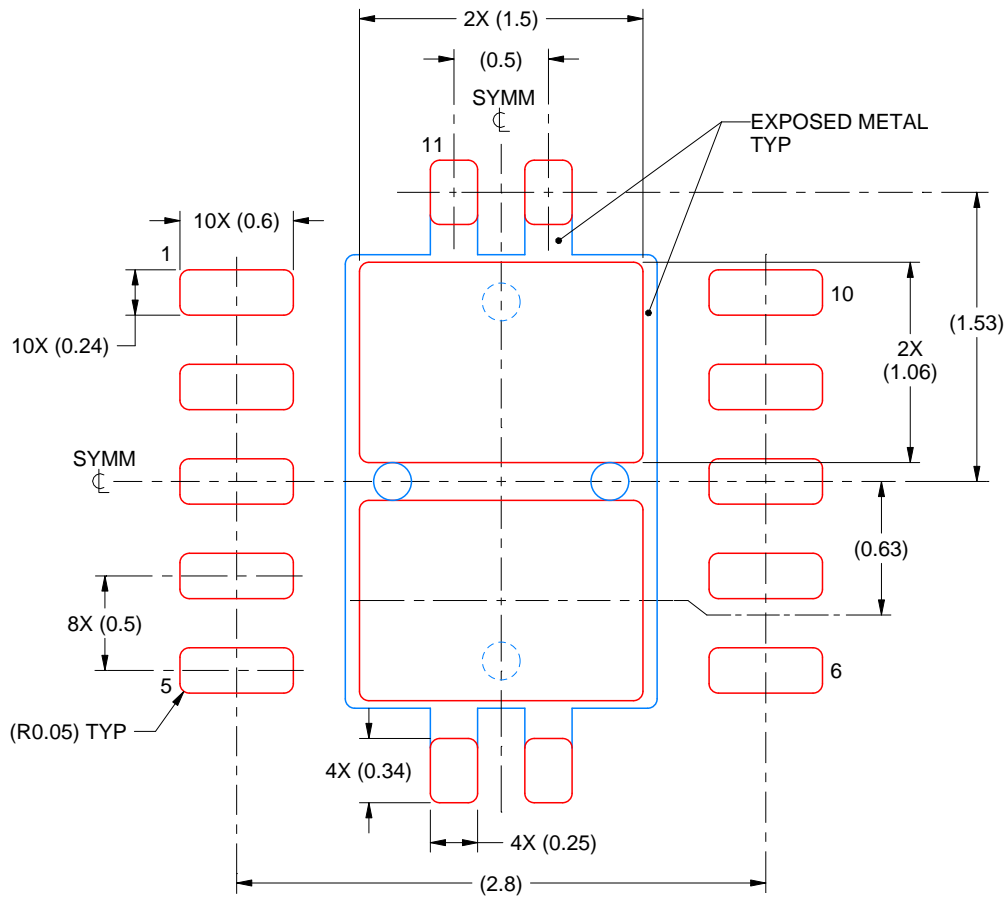

SOLDER PASTE EXAMPLE
BASED ON 0.125 mm THICK STENCIL

EXPOSED PAD 11:
80% PRINTED SOLDER COVERAGE BY AREA
SCALE:25X

4218878/B 07/2018

NOTES: (continued)

6. Laser cutting apertures with trapezoidal walls and rounded corners may offer better paste release. IPC-7525 may have alternate design recommendations.

重要声明和免责声明

TI 均以“原样”提供技术性及其可靠性数据（包括数据表）、设计资源（包括参考设计）、应用或其他设计建议、网络工具、安全信息和其他资源，不保证其中不含任何瑕疵，且不做任何明示或暗示的担保，包括但不限于对适销性、适合某特定用途或不侵犯任何第三方知识产权的暗示担保。

所述资源可供专业开发人员应用TI 产品进行设计使用。您将对以下行为独自承担全部责任：(1) 针对您的应用选择合适的TI 产品；(2) 设计、验证并测试您的应用；(3) 确保您的应用满足相应标准以及任何其他安全、安保或其他要求。所述资源如有变更，恕不另行通知。TI 对您使用所述资源的授权仅限于开发资源所涉及TI 产品的相关应用。除此之外不得复制或展示所述资源，也不提供其它TI 或任何第三方的知识产权授权许可。如因使用所述资源而产生任何索赔、赔偿、成本、损失及债务等，TI 对此概不负责，并且您须赔偿由此对TI 及其代表造成的损害。

TI 所提供产品均受TI 的销售条款 (<http://www.ti.com.cn/zh-cn/legal/termsofsale.html>) 以及ti.com.cn 上或随附TI 产品提供的其他可适用条款的约束。TI 提供所述资源并不扩展或以其他方式更改TI 针对TI 产品所发布的可适用的担保范围或担保免责声明。

邮寄地址：上海市浦东新区世纪大道 1568 号中建大厦 32 楼，邮政编码：200122

Copyright © 2020 德州仪器半导体技术（上海）有限公司