

# 3V VIDEO AMPLIFIER with Internal Gain and Filter in SC70

## FEATURES

- EXCELLENT VIDEO PERFORMANCE
- INTERNAL GAIN: 5.2V/V
- SUPPORTS TV-DETECTION
- COMPATIBLE WITH OMAP242x and DAVINCI™ PROCESSORS
- 2-POLE RECONSTRUCTION FILTER
- INPUT RANGE INCLUDES GROUND
  - DC-Coupled Input
- INTEGRATED LEVEL SHIFTER
  - DC-Coupled Output<sup>(1)</sup>
  - No Output Capacitors Needed
- RAIL-TO-RAIL OUTPUT
- LOW QUIESCENT CURRENT: 5.3mA
- SHUTDOWN CURRENT: 1.5μA
- SINGLE-SUPPLY: 2.5V to 3.3V
- SC70-6 PACKAGE: 2.0mm x 2.1mm
- RoHS COMPLIANT

<sup>(1)</sup> Internal circuitry avoids output saturation, even with 0V sync tip level at the input video signal.

## APPLICATIONS

- CAMERA PHONES

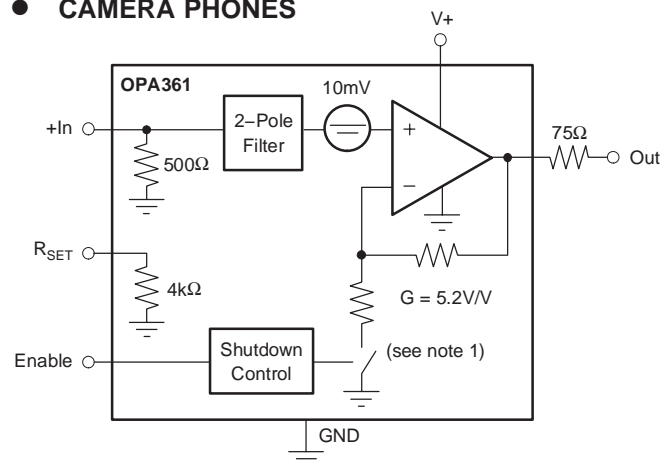

<sup>(1)</sup> Closed when enabled during normal operation; open when shut down.

## DESCRIPTION

The OPA361 high-speed amplifier is optimized for 3V portable video applications. It is specifically designed to be compatible with the video encoders embedded in Texas Instruments' OMAP2420 and DaVinci processors or other application processors with 0.5V<sub>PP</sub> video output. The input common-mode range includes GND, which allows a video-DAC (digital-to-analog converter) to be DC-coupled to the OPA361. The TV-detection feature simplifies the end-user interface significantly by facilitating the automatic start/stop of video transmission.

The output swings within 5mV of GND and 250mV to V+ with a standard back-terminated video load (150Ω). An internal level shift circuit prevents the output from saturating with 0V input, thus preventing sync-pulse clipping in common video circuits. Therefore, the OPA361 is ideally suited for DC-coupling to the video load.

The OPA361 has been optimized for space-sensitive applications by integrating internal gain setting resistors (G = 5.2V/V) and a 2-pole video-DAC reconstruction filter.

In shutdown mode, the quiescent current is reduced to < 1.5μA, dramatically reducing power consumption and prolonging battery life.

The OPA361 is available in the tiny 2mm x 2.1mm SC70-6 package.

## RELATED LOW VOLTAGE VIDEO AMPS

FEATURES	PRODUCT
2.7V to 3.3V, 70MHz, 6mA I <sub>Q</sub> , 5μA Sleep, SC70	OPA358
2.7V to 3.3V, Filter, SAG, G = 2, 5μA Sleep, SC70	OPA360
2.7V to 5.5V, 200MHz, 300V/μs, 6μA Sleep, SOT23	OPA355
2.7V to 5.5V, 100MHz, 150V/μs, 6μA Sleep, SOT23	OPA357



Please be aware that an important notice concerning availability, standard warranty, and use in critical applications of Texas Instruments semiconductor products and disclaimers thereto appears at the end of this data sheet.

DAVINCI is a registered trademark of Texas Instruments. All other trademarks are the property of their respective owners.

**ORDERING INFORMATION(1)**

PRODUCT	PACKAGE	PACKAGE DESIGNATOR	PACKAGE MARKING
OPA361	SC70-6	DCK	AUY

(1) For the most current package and ordering information, see the Package Option Addendum at the end of this datasheet, or see the TI website at [www.ti.com](http://www.ti.com).



This integrated circuit can be damaged by ESD. Texas Instruments recommends that all integrated circuits be handled with appropriate precautions. Failure to observe proper handling and installation procedures can cause damage.

ESD damage can range from subtle performance degradation to complete device failure. Precision integrated circuits may be more susceptible to damage because very small parametric changes could cause the device not to meet its published specifications.

**ABSOLUTE MAXIMUM RATINGS(1)**

Supply Voltage, V+ to V-	+3.6V
Signal Input Terminals, Voltage(2)	-0.5V to (V+) + 0.5V
Current(2)	±10mA
Output Short-Circuit through 75Ω to GND(3)	Continuous
Operating Temperature	-40°C to +125°C
Storage Temperature	-65°C to +150°C
Junction Temperature	+160°C
ESD Rating:	
Human Body Model	5000V
Machine Model	400V
Charged Device Model	2000V

- (1) Stresses above these ratings may cause permanent damage. Exposure to absolute maximum conditions for extended periods may degrade device reliability. These are stress ratings only, and functional operation of the device at these or any other conditions beyond those specified is not implied.
- (2) Input terminals are diode-clamped to the power-supply rails. Input signals that can swing more than 0.5V beyond the supply rails should be current-limited to 10mA or less.
- (3) Short-circuit to ground.

**PIN CONFIGURATION**

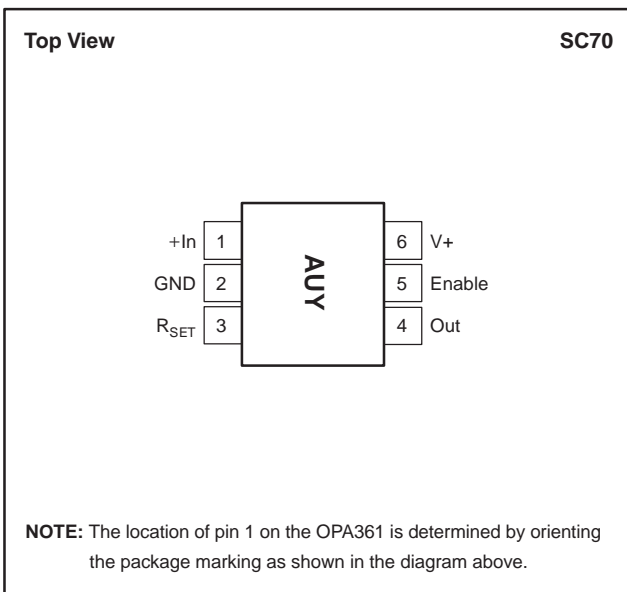

**ELECTRICAL CHARACTERISTICS:  $V_S = +2.5V$  to  $+3.3V$** 
**Boldface** limits apply over the temperature range,  $T_A = -40^\circ\text{C}$  to  $+125^\circ\text{C}$ .

 At  $T_A = +25^\circ\text{C}$ ,  $R_L = 150\Omega$  connected to GND, unless otherwise noted.

PARAMETER	CONDITIONS	OPA361			UNITS
		MIN	TYP	MAX	
<b>OFFSET LEVEL-SHIFT VOLTAGE</b>					
Output Level-Shift Voltage <sup>(1)</sup>	$V_S = +2.8V, V_{IN} = \text{GND}$	-3	11	55	mV
<b>Over Temperature</b>			<b>20</b>		<b>mV</b>
vs Power Supply	$V_S = +2.5V$ to $+3.3V$		$\pm 80$		$\mu\text{V/V}$
<b>INPUT VOLTAGE RANGE</b>					
Input Voltage Range <sup>(2)</sup>	$V_S = 2.5V$	GND		0.42	V
	$V_S = 2.8V$	GND		0.48	V
	$V_S = 3.3V$	GND		0.55	V
Input Resistance (+In)		450	510	550	$\Omega$
$R_{SET}$ Resistance		3600	4070	4400	$\Omega$
Matching of $R_{IN}$ and $R_{SET}$		2	0.5		%
<b>VOLTAGE GAIN</b>					
	$\Delta V_{OUT}/\Delta V_{IN}, V_S = +2.5V, V_{INMIN} = 0V, V_{INMAX} = 0.42V$	5.06	5.17	5.28	V/V
	$\Delta V_{OUT}/\Delta V_{IN}, V_S = +2.8V, V_{INMIN} = 0V, V_{INMAX} = 0.48V$	5.06	5.17	5.28	V/V
	$\Delta V_{OUT}/\Delta V_{IN}, V_S = +3.3V, V_{INMIN} = 0V, V_{INMAX} = 0.55V$	5.06	5.17	5.28	V/V
<b>FREQUENCY RESPONSE</b>					
Filter Response					
Cutoff Frequency	$f_{-3dB}$		9		MHz
Normalized Gain: $f_{IN} = 4.5\text{MHz}$	$V_O = 2V_{PP}$		-0.1		dB
$f_{IN} = 27\text{MHz}$	$V_O = 2V_{PP}$		-18		dB
$f_{IN} = 54\text{MHz}$	$V_O = 2V_{PP}$		-23		dB
Differential Gain Error	$R_L = 150\Omega$		1.2		%
Differential Phase Error	$R_L = 150\Omega$		1.6		degrees
Group Delay Variation	100kHz, 4.5MHz		26		ns
Signal-to-Noise Ratio	100% White Signal		65		dB
<b>OUTPUT</b>					
Positive Voltage Output Swing from Rail	$V_S = +2.8V, V_{IN} = 0.7V, R_L = 150\Omega$ to GND		130	250	mV
Negative Voltage Output Swing from Rail	$V_S = +2.8V, V_{IN} = -0.05V, R_L = 150\Omega$ to GND		0.15	5	mV
Positive Voltage Output Swing from Rail	$V_S = +2.8V, V_{IN} = 0.7V, R_L = 75\Omega$ to GND		260		mV
Negative Voltage Output Swing from Rail	$V_S = +2.8V, V_{IN} = -0.05V, R_L = 75\Omega$ to GND		2		mV
Output Leakage	$V_S = +2.8V, \text{Disabled}, V_O = 2V$		0.3	100	nA
Output Current <sup>(3)</sup>	$V_S = +2.8V$		$\pm 80$		mA
<b>POWER SUPPLY</b>					
Specified Voltage Range	$V_S$	2.5		3.3	V
Quiescent Current	$V_S = +2.8V, \text{Enabled}, I_O = 0, V_{OUT} = 1.4V$		5.3	7.5	mA
<b>Over Temperature</b>	<b>Specified Temperature Range</b>			<b>9</b>	<b>mA</b>
<b>ENABLE/SHUTDOWN FUNCTION</b>					
Disabled (logic-LOW threshold)		0		0.35	V
Enabled (logic-HIGH threshold)		1.3		$V_S$	V
Enable Time			1.5		$\mu\text{s}$
Disable Time			50		ns
Shutdown Current	$V_S = +2.8V, \text{Disabled}$		1.5	3	$\mu\text{A}$
<b>TEMPERATURE RANGE</b>					
Specified/Operating Range		-40		+125	$^\circ\text{C}$
Storage Range		-65		+150	$^\circ\text{C}$
Thermal Resistance	$\theta_{JA}$				$^\circ\text{C/W}$
SC70			250		$^\circ\text{C/W}$

(1) Output referred.

 (2) Limited by output swing and internal  $G = 5.2V/V$ .

 (3) See typical characteristics *Output Voltage Swing vs Output Current*.

**TYPICAL CHARACTERISTICS:  $V_S = 2.8V$**

At  $T_A = +25^\circ C$  and  $R_L = 150\Omega$ , unless otherwise noted.

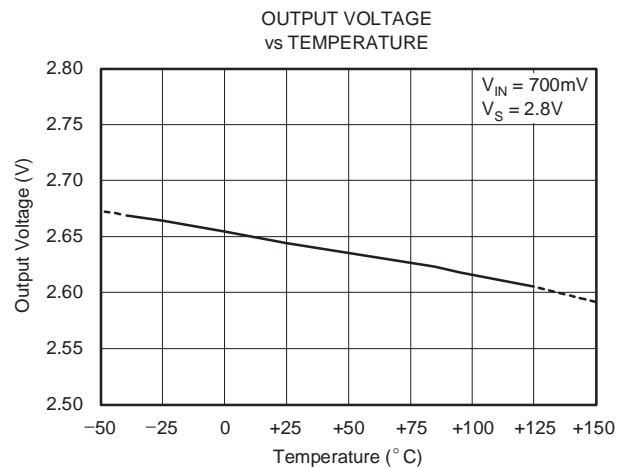
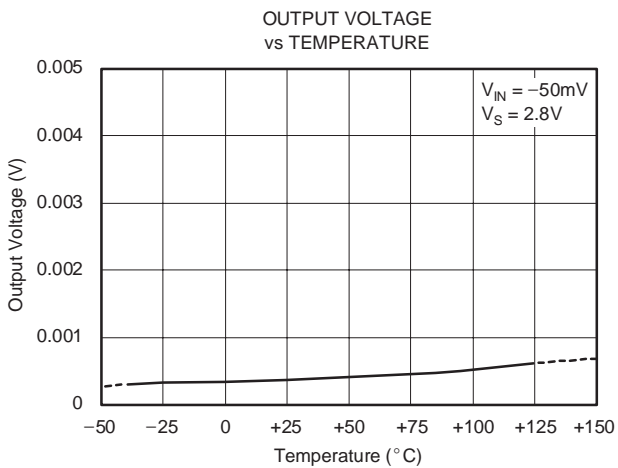
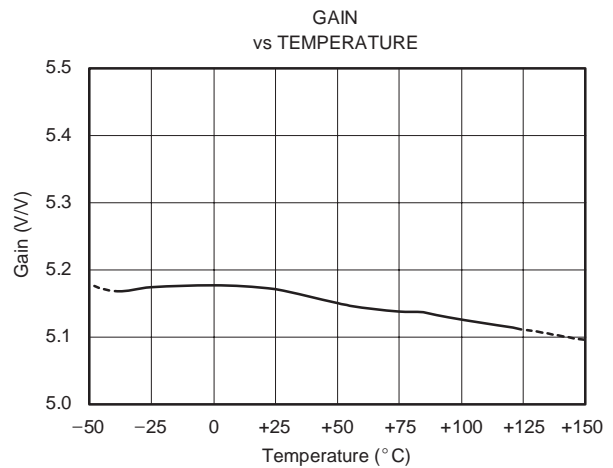
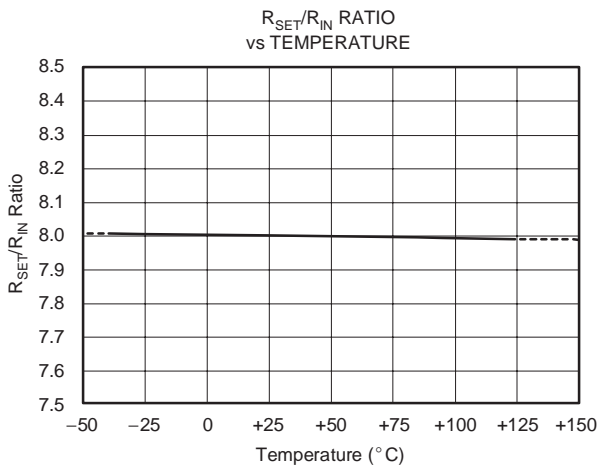
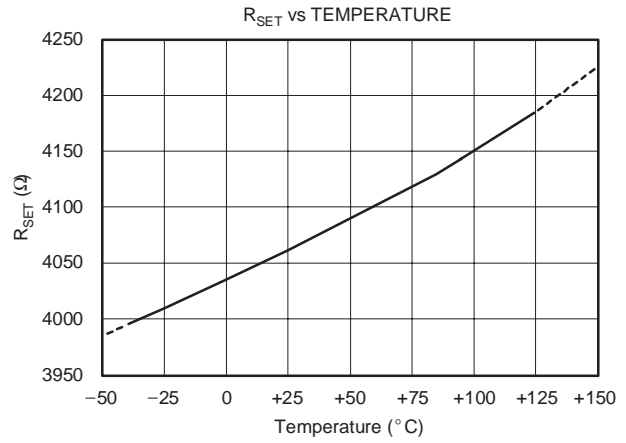
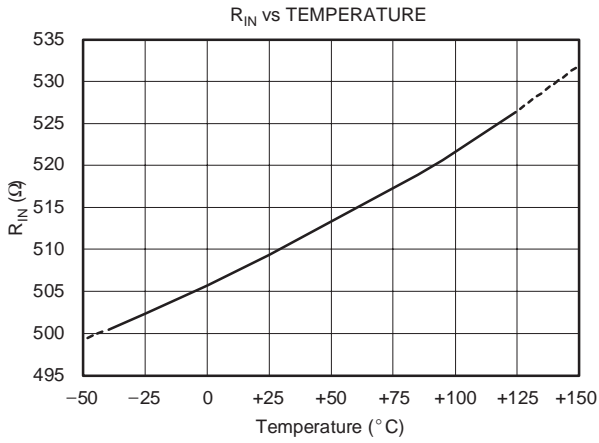

**TYPICAL CHARACTERISTICS:  $V_S = 2.8V$  (continued)**

At  $T_A = +25^\circ C$  and  $R_L = 150\Omega$ , unless otherwise noted.

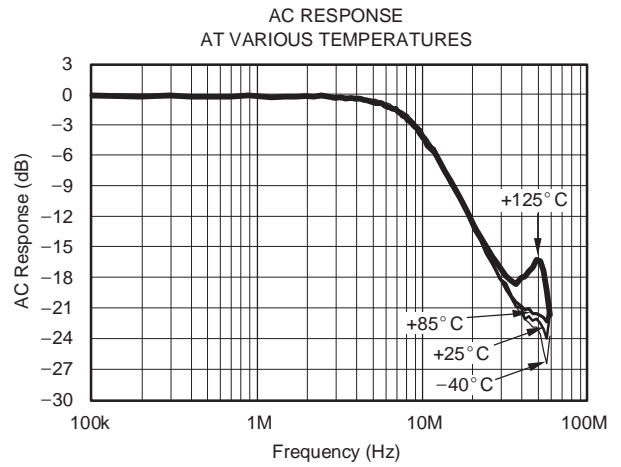
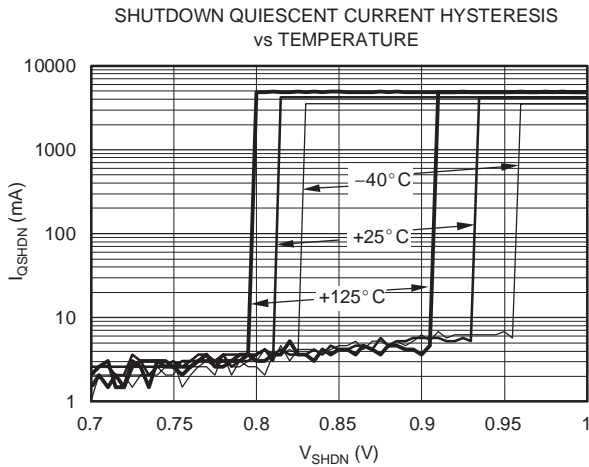
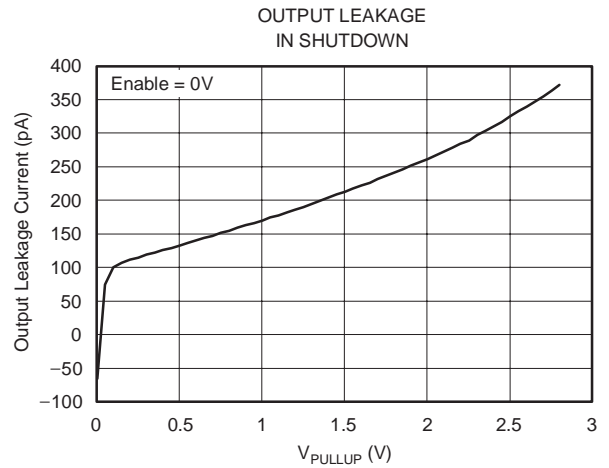
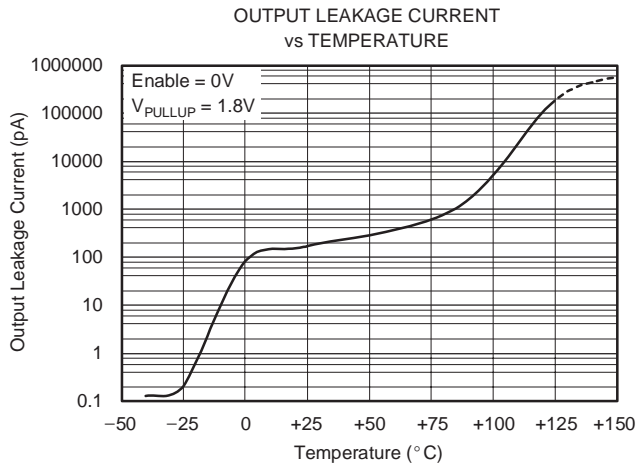
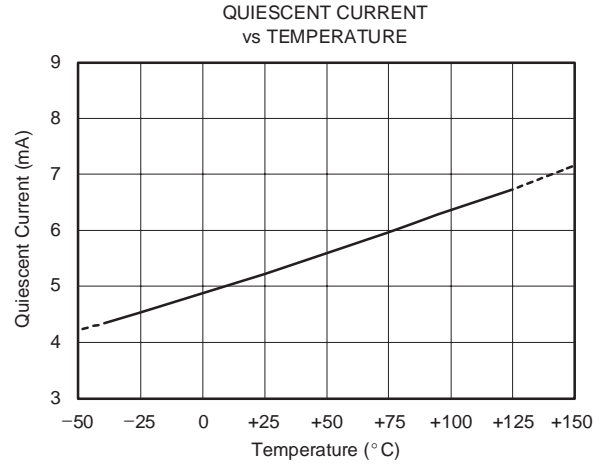
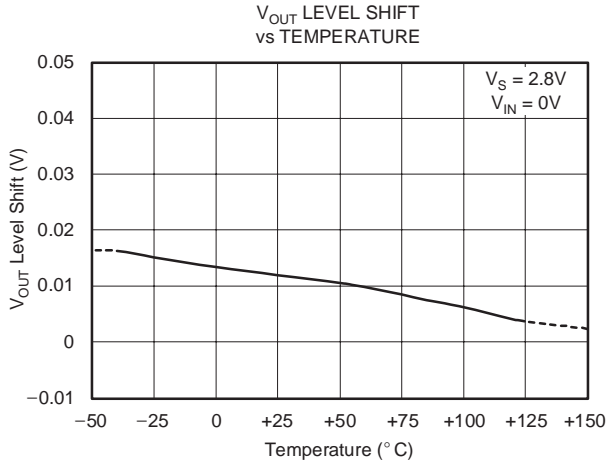

**TYPICAL CHARACTERISTICS:  $V_S = 2.8V$  (continued)**

At  $T_A = +25^\circ C$  and  $R_L = 150\Omega$ , unless otherwise noted.

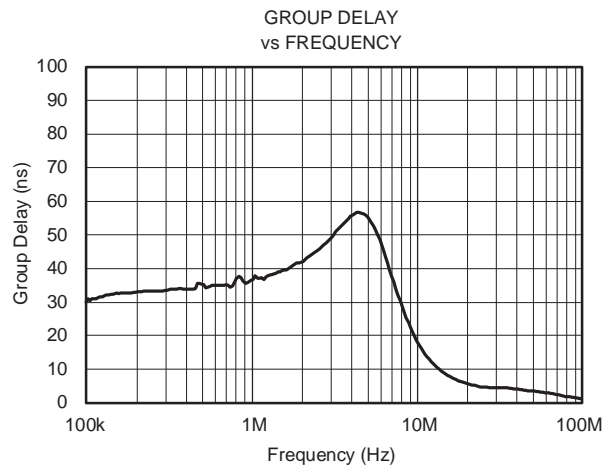
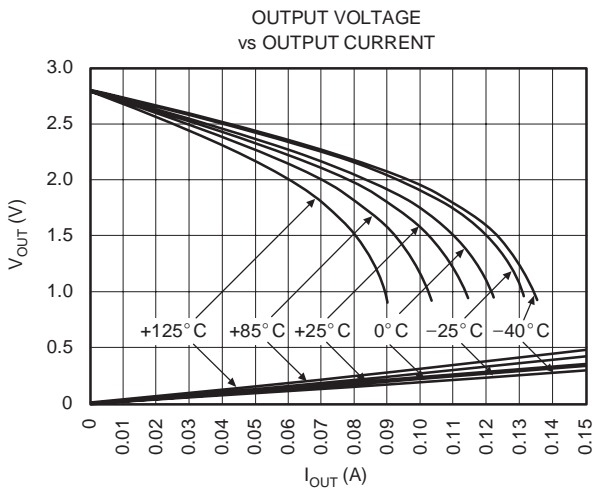
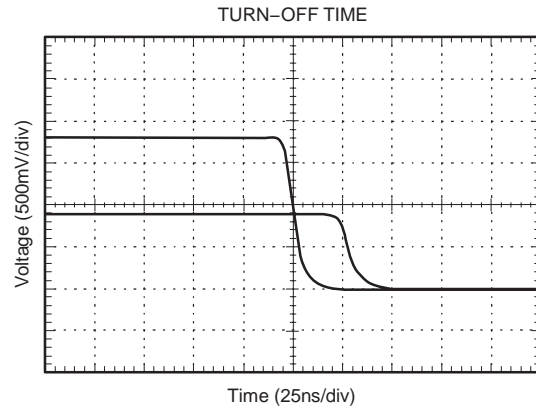
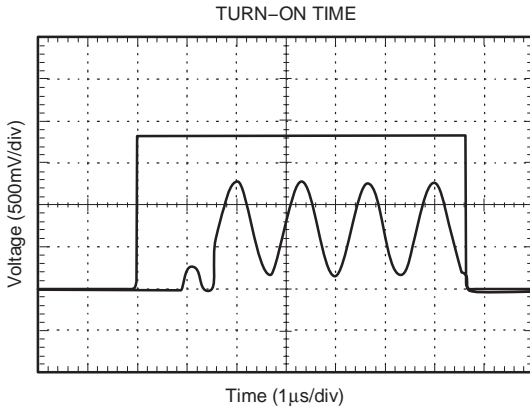

**DIFFERENTIAL GAIN**

INP	A	C	SYNC	INT	MTIME	10s	LINE	330
DG1	-0.6	%1	-5	0	+	+	+	+
DG2	-1.0	%.						
DG3	-1.1	%.						
DG4	-1.2	%.						
DG5	-0.8	%5						
STEPS		ZOOM		MODE				
4 5		0 1 2		1				

**DIFFERENTIAL PHASE**

INP	A	C	SYNC	INT	MTIME	10s	LINE	330
DP1	1.1	dg1	-5	0	+	+	+	+
DP2	1.6	dg.						
DP3	1.6	dg.						
DP4	1.5	dg.						
DP5	1.1	dg5						
STEPS		ZOOM		MODE				
4 5		0 1 2		1				

## APPLICATIONS INFORMATION

The OPA361 video amplifier has been optimized to fit seamlessly with Texas Instruments' OMAP242x Multimedia processor. The following features have been integrated to provide excellent video performance.

- Internal gain setting resistors ( $G = 5.2V/V$ ) reduce the number of external components needed in the video circuit.
- Integration of the  $500\Omega$  video encoder load resistor and  $4k\Omega$   $R_{SET}$  resistor used by the OMAP242x helps minimize the number of external components and also ensures excellent ratio and temperature tracking. This feature helps to keep the overall gain accurate and stable over temperature.
- TV-detection support in connection with an OMAP242x multimedia processor. This feature

helps to automate start/stop operation of the TV-out function and minimizes power consumption.

- A 2-pole filter is incorporated for DAC signal reconstruction.
- The OPA361 employs an internal level shift circuit that avoids sync pulse clipping and allows DC-coupled output.
- A shutdown feature reduces quiescent current to less than  $1.5\mu A$ —crucial for portable applications

Although OPA361 is optimized for the OMAP242x processor, it is also suitable to interface with any digital media processor that outputs a video signal on the order of  $0.4V_{PP}$  to  $0.5V_{PP}$ .

Figure 1 shows a typical application drawing with the OMAP242x processor and the TWL92230 Energy Management Chip.

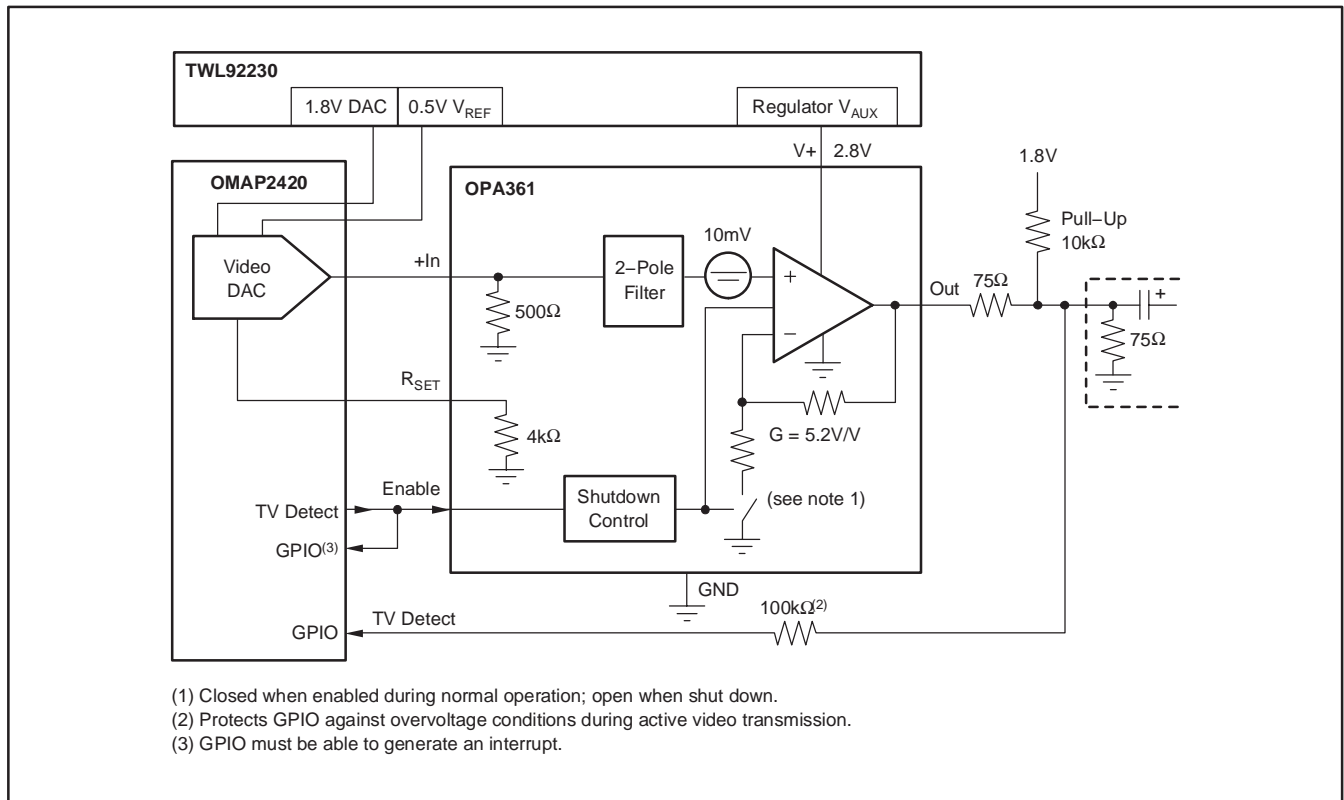

**Figure 1. Typical Application using the OMAP242x and the TWL92230**

## OPERATING VOLTAGE

The OPA361 is fully specified from 2.5V to 3.3V over a temperature range of  $-40^{\circ}\text{C}$  to  $+125^{\circ}\text{C}$ . Parameters that vary significantly with operating voltages or temperature are shown in the Typical Characteristics. Power-supply pins should be bypassed with 100nF ceramic capacitors.

## INPUT VOLTAGE

The input common-mode range of the OPA361 series extends from GND to 0.55V on a 3.3V supply. The input range is limited by the internal gain in conjunction with the maximum output swing capability and the power-supply voltage.

## INPUT OVERVOLTAGE PROTECTION

All OPA361 pins are static-protected with internal ESD protection diodes connected to the supplies. These diodes will provide input overdrive protection if the current is externally limited to 10mA.

## ENABLE/SHUTDOWN

The OPA361 has a shutdown feature that disables the output and reduces the quiescent current to less than  $1.5\mu\text{A}$ . This feature is especially useful for portable video applications, where the device is infrequently connected to a television (TV) or other video device.

The Enable logic input voltage is referenced to the OPA361 GND pin. A logic level HIGH applied to the enable pin enables the op amp. The logic levels are compatible with 1.8V CMOS logic levels. A valid logic HIGH is defined as  $> 1.3\text{V}$  above GND. A valid logic LOW is defined as  $< 0.35\text{V}$  above GND. If the Enable pin is not connected, internal pull-up circuitry will enable the amplifier.

When disabling the OPA361, internal circuitry also disconnects the internal gain setting feedback. This feature is in support of the TV-detection function. See the *TV-Detect Function* section for more detailed information.

## INTERNAL 2-POLE FILTER

The OPA361 filter is a Sallen-Key topology with a 9MHz cutoff frequency. Figure 2 shows a detailed drawing of the filter components. This filter allows video signals to pass without any visible distortion, as shown in Figure 3 through Figure 6. The video encoder embedded in the OMAP242x processor typically samples at 54MHz. At this frequency, the attenuation is typically 23dB, which effectively attenuates the sampling aliases.

The internal  $500\Omega$  resistor on the input to GND converts the output current of the OMAP2420 internal video DAC into a voltage. It is also part of the Sallen-Key filter. Using an external resistor to adjust the input voltage range will also alter the filter characteristics.

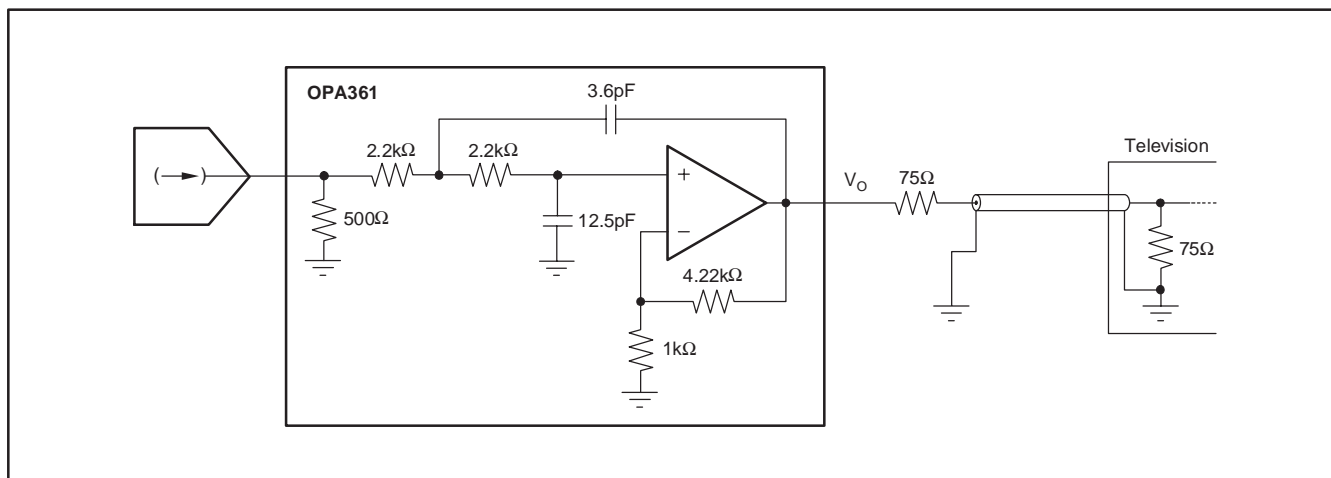
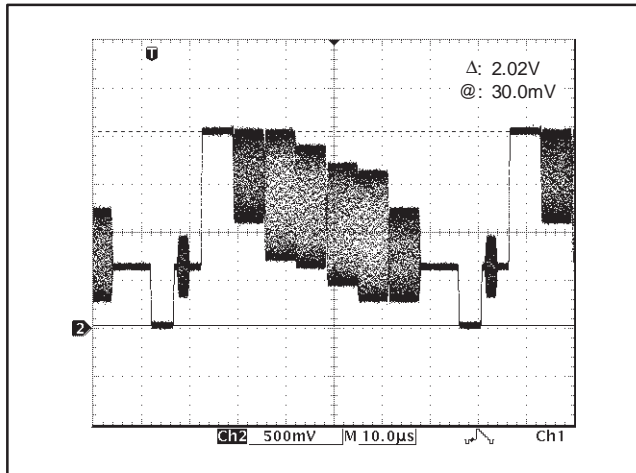

Figure 2. Filter Structure of the OPA361

**Video Performance**

The color bar signal in Figure 3 shows excellent amplitude characteristics and no attenuation of colors with respect to the luminance signal.



**Figure 3. 100/75 Color Bar Signal at Output of OPA361**

The CCIR330/5 test pattern requires one of the greatest dynamic ranges, and therefore tests the OPA361 output voltage swing capability. The scope plot shown in Figure 4 has been taken with a 2.8V supply and shows no clipping on the top side of the signal.

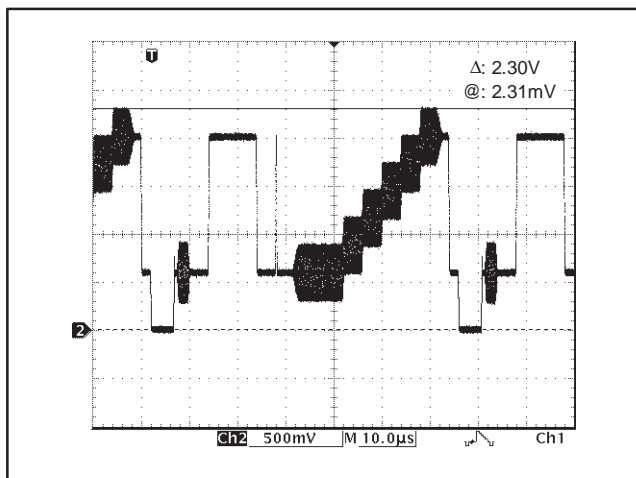

**Figure 4. CCIR330/5: No Clipping, Even On 2.8V Supply**

The multiburst test patterns have different sine-wave burst sections with the following frequencies: 0.5MHz, 1MHz, 2MHz, 4MHz, 4.8MHz and 5.8MHz with 420mV<sub>PP</sub>. There is no visible attenuation even at the highest frequencies, which indicates a very flat frequency response of the OPA361. As shown in Figure 5 and Figure 6, the top line illustrates the full signal and the bottom line is a more detailed view of the last three sine wave bursts.

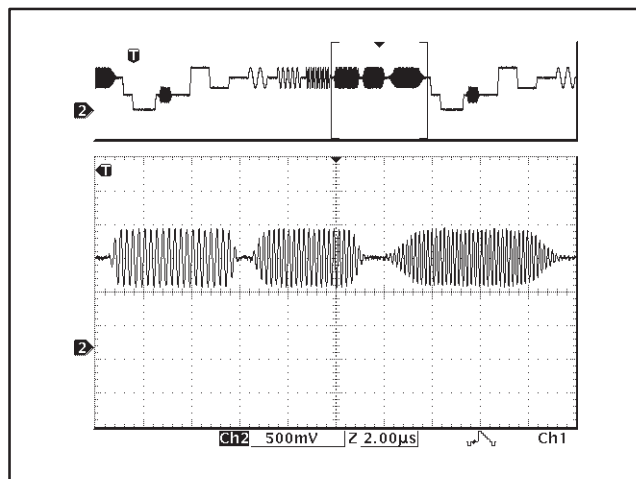

**Figure 5. Multiburst Signal (CCIR 18/1) Shows Very Flat Frequency Response**

The CCIR17 test pattern contains a 2T and a 20T pulse, as shown in Figure 6. The 2T pulse is used to check for pulse distortion and reflection, and the 20T pulse is used to check for amplitude and group delay between chrominance and luminance. Neither pulse exhibits any distortion or group delay artifacts.

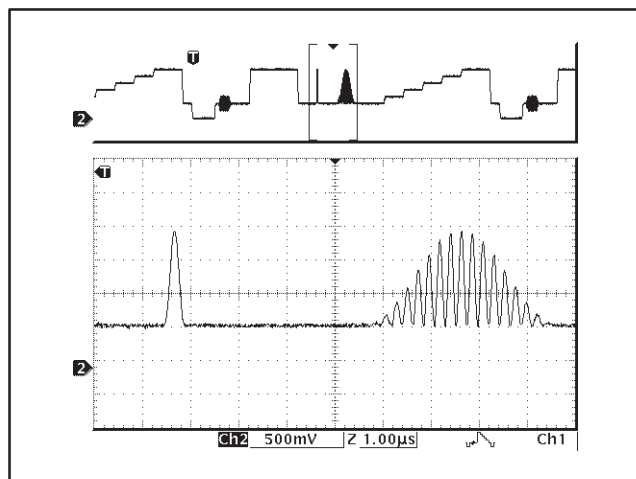

**Figure 6. CCIR 17 2T and 20T Pulses Show No Visible Distortion**

### INTERNAL LEVEL SHIFT

Many common video DACs embedded in digital media processors, like the new OMAP242x processors, operate on a single supply (no negative supply). Typically, the lowest point of the sync pulse output by these video DACs is close to 0V. With a 0V input, the output of a common single-supply op amp saturates at a voltage > 0V. This effect would clip the sync pulse, and therefore degrade the video signal integrity. The OPA361 employs an internal level shift circuit to avoid clipping. The input signal is typically shifted by approximately 11mV. This shift is well within the linear output voltage range of the OPA361 with a standard 150Ω video load.

### Output Swing Capability

Figure 7 shows the true output swing capability of the OPA361 by taking the tip of the input sync pulse to a slightly negative voltage. Even when the output sync tip is at 3mV, the output after the 75Ω series termination still shows no clipping of the sync pulse.

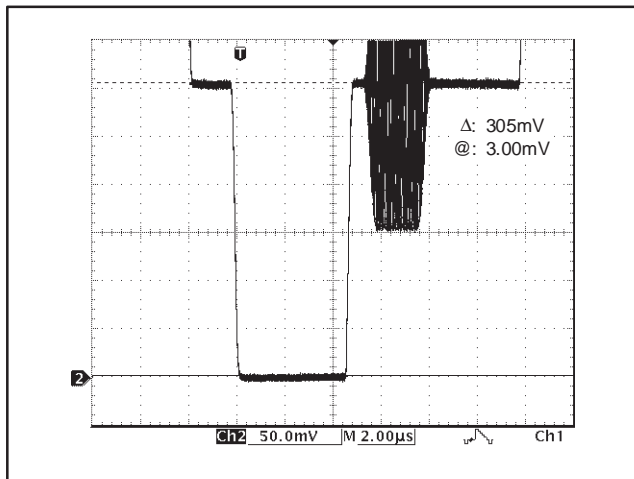

Figure 7. No Clipping of the Sync Pulse

### TV-Detect Function

The TV-detection feature of the OPA361 works in conjunction with the OMAP242x (or other processors) to detect if a television is connected to the video output of the device. In order to detect a TV load, the OPA361 is briefly turned off, ideally during the first vertical sync pulse. For the detection, a simple pull-up resistor to the processor logic supply is used on the output of the OPA361. The

voltage level is pulled LOW if the TV (or other video equipment) is connected, or HIGH if nothing is connected. A GPIO in the processor can be used to read this logic level and decide if a video load is connected. Figure 8 shows a scope plot with the TV disconnected and Figure 9 shows a scope plot with the TV connected; the upper line in both figures is the disable pulse. Figure 10 shows a circuit drawing using the TV-detect signal to disable or enable the OPA361.

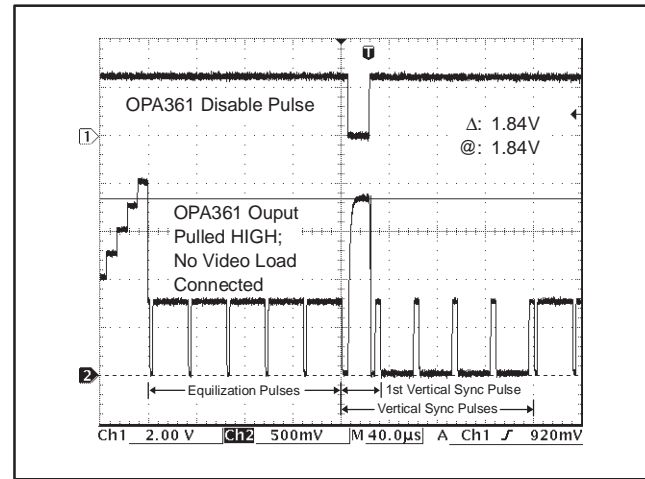

Figure 8. Output of OPA361 Pulled Up To 1.8V During Disable: TV Disconnected

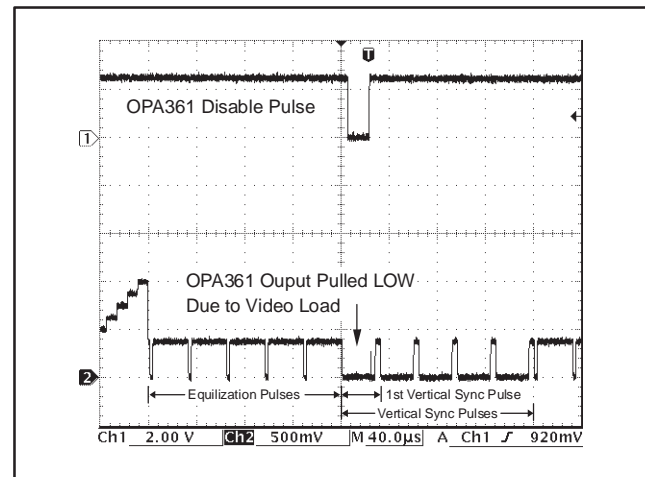
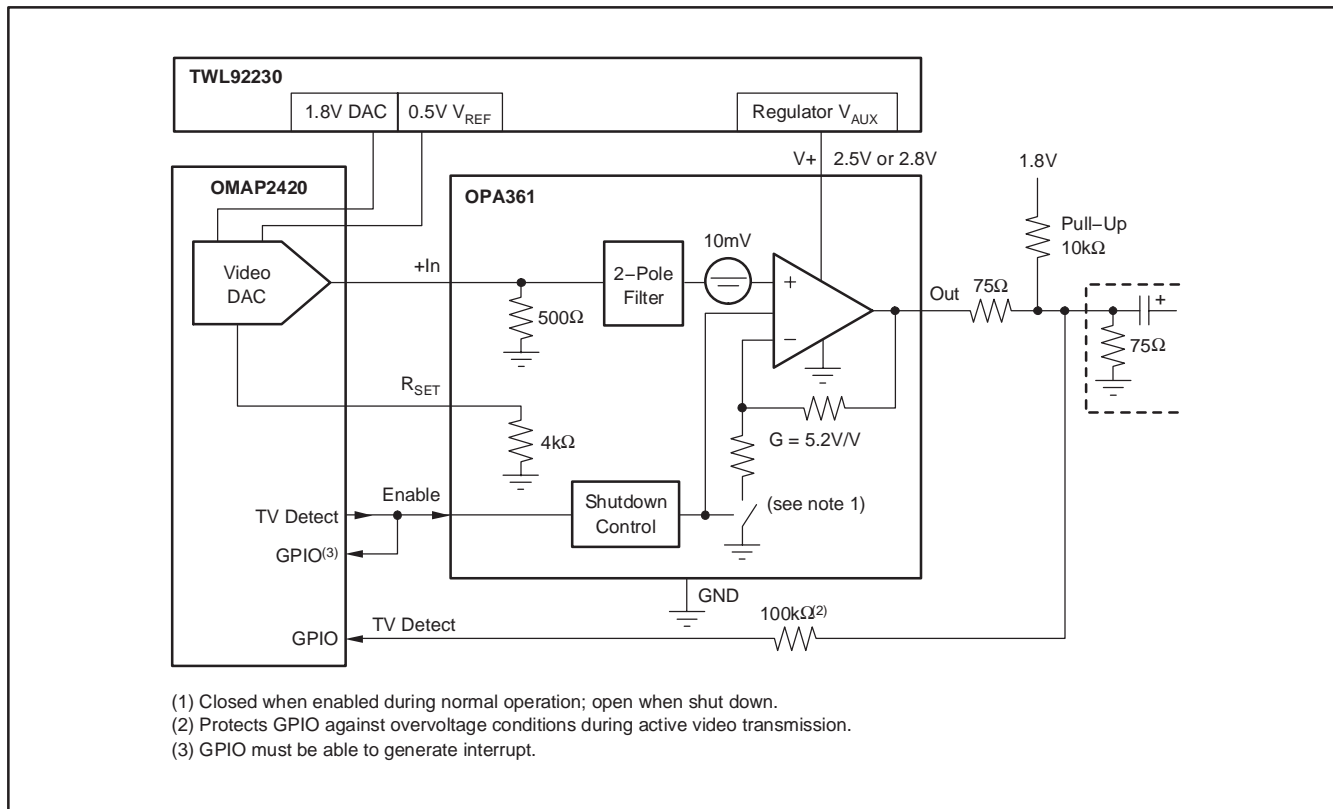

Figure 9. Output of OPA361 Pulled Down: TV Connected.



**Figure 10. Using TV-Detect Signal to Disable/Enable the OPA361**

Disabling the OPA361 also disconnects the internal feedback resistors' path to GND, and therefore there is no current flowing from the logic supply through the pull-up resistor to GND if no video load is connected; this helps to conserve battery life. The typical leakage when the output is pulled high and OPA361 is disabled is only about 300pA.

The following functionality can be achieved by implementing TV-detection:

- Automatic video start by *polling* the video line periodically.
- Automatic video stop if the TV (or other equipment) is disconnected.

Proper implementation allows to significantly simplify the user interface.

For more information, see Application Report SBOA109, *OPA361 and TV Detection*, available for download at [www.ti.com](http://www.ti.com).

**PACKAGING INFORMATION**

Orderable Device	Status (1)	Package Type	Package Drawing	Pins	Package Qty	Eco Plan (2)	Lead finish/ Ball material (6)	MSL Peak Temp (3)	Op Temp (°C)	Device Marking (4/5)	Samples
OPA361AIDCKR	ACTIVE	SC70	DCK	6	3000	RoHS & Green	NIPDAU	Level-2-260C-1 YEAR	-40 to 125	AUY	<a href="#">Samples</a>
OPA361AIDCKT	ACTIVE	SC70	DCK	6	250	RoHS & Green	NIPDAU	Level-2-260C-1 YEAR	-40 to 125	AUY	<a href="#">Samples</a>
OPA361AIDCKTG4	ACTIVE	SC70	DCK	6	250	RoHS & Green	NIPDAU	Level-2-260C-1 YEAR	-40 to 125	AUY	<a href="#">Samples</a>

(1) The marketing status values are defined as follows:

**ACTIVE:** Product device recommended for new designs.

**LIFEBUY:** TI has announced that the device will be discontinued, and a lifetime-buy period is in effect.

**NRND:** Not recommended for new designs. Device is in production to support existing customers, but TI does not recommend using this part in a new design.

**PREVIEW:** Device has been announced but is not in production. Samples may or may not be available.

**OBSOLETE:** TI has discontinued the production of the device.

(2) **RoHS:** TI defines "RoHS" to mean semiconductor products that are compliant with the current EU RoHS requirements for all 10 RoHS substances, including the requirement that RoHS substance do not exceed 0.1% by weight in homogeneous materials. Where designed to be soldered at high temperatures, "RoHS" products are suitable for use in specified lead-free processes. TI may reference these types of products as "Pb-Free".

**RoHS Exempt:** TI defines "RoHS Exempt" to mean products that contain lead but are compliant with EU RoHS pursuant to a specific EU RoHS exemption.

**Green:** TI defines "Green" to mean the content of Chlorine (Cl) and Bromine (Br) based flame retardants meet JS709B low halogen requirements of <=1000ppm threshold. Antimony trioxide based flame retardants must also meet the <=1000ppm threshold requirement.

(3) MSL, Peak Temp. - The Moisture Sensitivity Level rating according to the JEDEC industry standard classifications, and peak solder temperature.

(4) There may be additional marking, which relates to the logo, the lot trace code information, or the environmental category on the device.

(5) Multiple Device Markings will be inside parentheses. Only one Device Marking contained in parentheses and separated by a "~" will appear on a device. If a line is indented then it is a continuation of the previous line and the two combined represent the entire Device Marking for that device.

(6) Lead finish/Ball material - Orderable Devices may have multiple material finish options. Finish options are separated by a vertical ruled line. Lead finish/Ball material values may wrap to two lines if the finish value exceeds the maximum column width.

**Important Information and Disclaimer:**The information provided on this page represents TI's knowledge and belief as of the date that it is provided. TI bases its knowledge and belief on information provided by third parties, and makes no representation or warranty as to the accuracy of such information. Efforts are underway to better integrate information from third parties. TI has taken and continues to take reasonable steps to provide representative and accurate information but may not have conducted destructive testing or chemical analysis on incoming materials and chemicals. TI and TI suppliers consider certain information to be proprietary, and thus CAS numbers and other limited information may not be available for release.

In no event shall TI's liability arising out of such information exceed the total purchase price of the TI part(s) at issue in this document sold by TI to Customer on an annual basis.

**OTHER QUALIFIED VERSIONS OF OPA361 :**

- Automotive: [OPA361-Q1](#)

NOTE: Qualified Version Definitions:

- Automotive - Q100 devices qualified for high-reliability automotive applications targeting zero defects

## TAPE AND REEL INFORMATION



### QUADRANT ASSIGNMENTS FOR PIN 1 ORIENTATION IN TAPE



\*All dimensions are nominal

Device	Package Type	Package Drawing	Pins	SPQ	Reel Diameter (mm)	Reel Width W1 (mm)	A0 (mm)	B0 (mm)	K0 (mm)	P1 (mm)	W (mm)	Pin1 Quadrant
OPA361AIDCKR	SC70	DCK	6	3000	178.0	9.0	2.4	2.5	1.2	4.0	8.0	Q3
OPA361AIDCKR	SC70	DCK	6	3000	179.0	8.4	2.2	2.5	1.2	4.0	8.0	Q3
OPA361AIDCKT	SC70	DCK	6	250	178.0	9.0	2.4	2.5	1.2	4.0	8.0	Q3
OPA361AIDCKT	SC70	DCK	6	250	179.0	8.4	2.25	2.4	1.22	4.0	8.0	Q3

**TAPE AND REEL BOX DIMENSIONS**

\*All dimensions are nominal

Device	Package Type	Package Drawing	Pins	SPQ	Length (mm)	Width (mm)	Height (mm)
OPA361AIDCKR	SC70	DCK	6	3000	180.0	180.0	18.0
OPA361AIDCKR	SC70	DCK	6	3000	213.0	191.0	35.0
OPA361AIDCKT	SC70	DCK	6	250	180.0	180.0	18.0
OPA361AIDCKT	SC70	DCK	6	250	213.0	191.0	35.0

DCK (R-PDSO-G6)

PLASTIC SMALL-OUTLINE PACKAGE

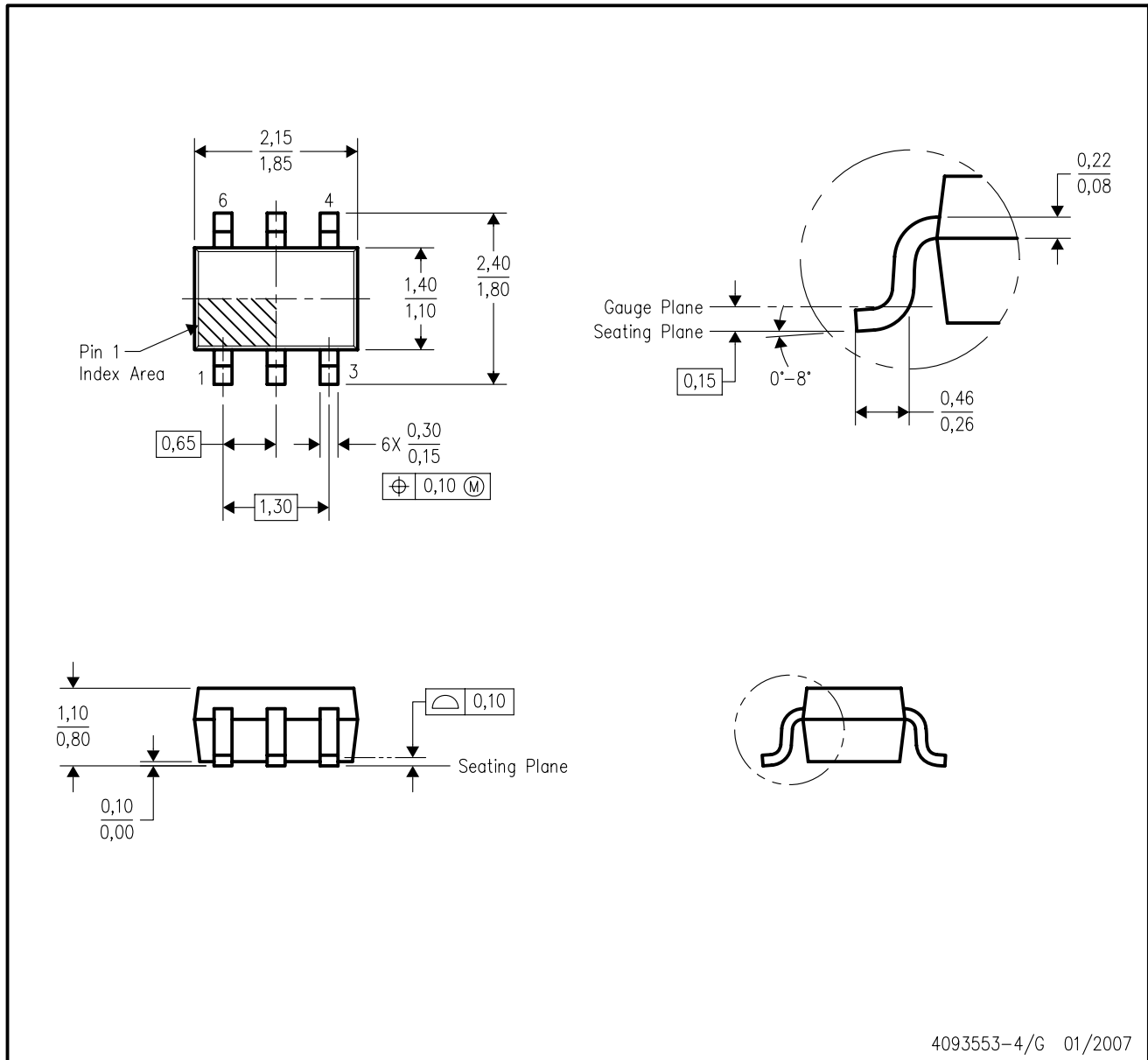

- NOTES:
- A. All linear dimensions are in millimeters.
  - B. This drawing is subject to change without notice.
  - C. Body dimensions do not include mold flash or protrusion. Mold flash and protrusion shall not exceed 0.15 per side.
  - D. Falls within JEDEC MO-203 variation AB.

DCK (R-PDSO-G6)

PLASTIC SMALL OUTLINE

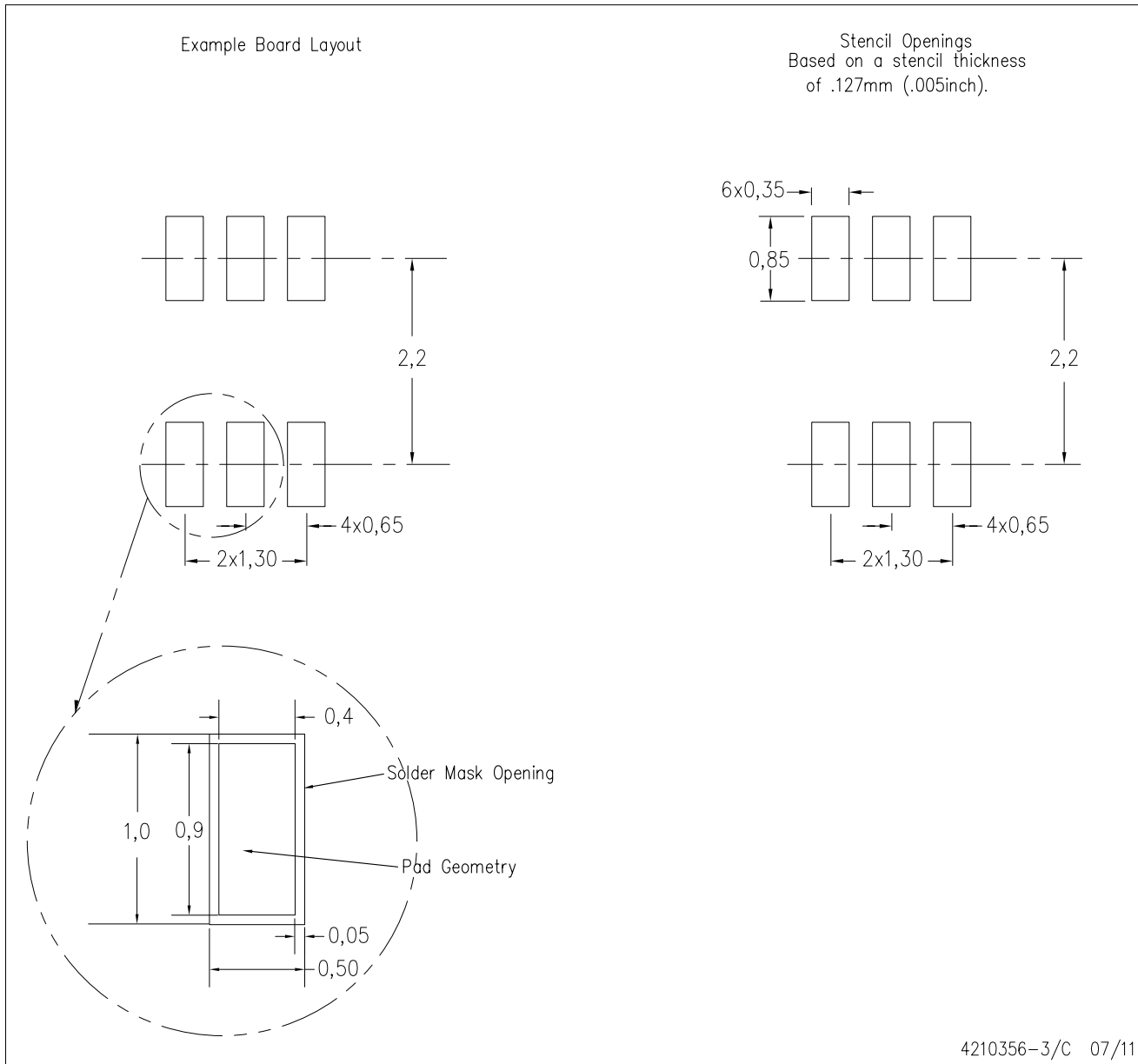

- NOTES:
- A. All linear dimensions are in millimeters.
  - B. This drawing is subject to change without notice.
  - C. Customers should place a note on the circuit board fabrication drawing not to alter the center solder mask defined pad.
  - D. Publication IPC-7351 is recommended for alternate designs.
  - E. Laser cutting apertures with trapezoidal walls and also rounding corners will offer better paste release. Customers should contact their board assembly site for stencil design recommendations. Example stencil design based on a 50% volumetric metal load solder paste. Refer to IPC-7525 for other stencil recommendations.

## IMPORTANT NOTICE AND DISCLAIMER

TI PROVIDES TECHNICAL AND RELIABILITY DATA (INCLUDING DATASHEETS), DESIGN RESOURCES (INCLUDING REFERENCE DESIGNS), APPLICATION OR OTHER DESIGN ADVICE, WEB TOOLS, SAFETY INFORMATION, AND OTHER RESOURCES "AS IS" AND WITH ALL FAULTS, AND DISCLAIMS ALL WARRANTIES, EXPRESS AND IMPLIED, INCLUDING WITHOUT LIMITATION ANY IMPLIED WARRANTIES OF MERCHANTABILITY, FITNESS FOR A PARTICULAR PURPOSE OR NON-INFRINGEMENT OF THIRD PARTY INTELLECTUAL PROPERTY RIGHTS.

These resources are intended for skilled developers designing with TI products. You are solely responsible for (1) selecting the appropriate TI products for your application, (2) designing, validating and testing your application, and (3) ensuring your application meets applicable standards, and any other safety, security, or other requirements. These resources are subject to change without notice. TI grants you permission to use these resources only for development of an application that uses the TI products described in the resource. Other reproduction and display of these resources is prohibited. No license is granted to any other TI intellectual property right or to any third party intellectual property right. TI disclaims responsibility for, and you will fully indemnify TI and its representatives against, any claims, damages, costs, losses, and liabilities arising out of your use of these resources.

TI's products are provided subject to TI's Terms of Sale (<https://www.ti.com/legal/termsofsale.html>) or other applicable terms available either on [ti.com](https://www.ti.com) or provided in conjunction with such TI products. TI's provision of these resources does not expand or otherwise alter TI's applicable warranties or warranty disclaimers for TI products.

Mailing Address: Texas Instruments, Post Office Box 655303, Dallas, Texas 75265  
Copyright © 2021, Texas Instruments Incorporated