

## LMP2014MT Quad High Precision, Rail-to-Rail Output Operational Amplifier

Check for Samples: [LMP2014MT](#)

### FEATURES

- (For  $V_S = 5V$ , Typical Unless Otherwise Noted)
- Low Specified  $V_{OS}$  Over Temperature  $60 \mu V$
- Low Noise with No  $1/f$   $35nV/\sqrt{Hz}$
- High CMRR 130 dB
- High PSRR 120 dB
- High  $A_{VOL}$  130 dB
- Wide Gain-Bandwidth Product 3 MHz
- High Slew Rate 4 V/ $\mu s$
- Low Supply Current 3.7 mA
- Rail-to-Rail Output 30 mV
- No External Capacitors Required

### APPLICATIONS

- Precision Instrumentation Amplifiers
- Thermocouple Amplifiers
- Strain Gauge Bridge Amplifier

### DESCRIPTION

The LMP2014MT is a member of Texas Instruments' new LMP™ precision amplifier family. The LMP2014MT offers unprecedented accuracy and stability while also being offered at an affordable price. This device utilizes patented techniques to measure and continually correct the input offset error voltage. The result is an amplifier which is ultra stable over time and temperature. It has excellent CMRR and PSRR ratings, and does not exhibit the familiar  $1/f$  voltage and current noise increase that plagues traditional amplifiers. The combination of the LMP2014 characteristics makes it a good choice for transducer amplifiers, high gain configurations, ADC buffer amplifiers, DAC I-V conversion, and any other 2.7V-5V application requiring precision and long term stability.

Other useful benefits of the LMP2014 are rail-to-rail output, a low supply current of 3.7 mA, and wide gain-bandwidth product of 3 MHz. These extremely versatile features found in the LMP2014 provide high performance and ease of use.

### Connection Diagram

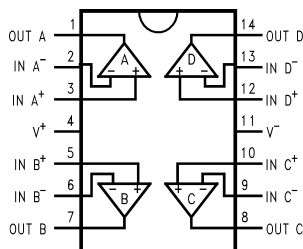

**Figure 1. 14-Pin TSSOP – Top View**  
See Package Number PW



Please be aware that an important notice concerning availability, standard warranty, and use in critical applications of Texas Instruments semiconductor products and disclaimers thereto appears at the end of this data sheet.

All trademarks are the property of their respective owners.



These devices have limited built-in ESD protection. The leads should be shorted together or the device placed in conductive foam during storage or handling to prevent electrostatic damage to the MOS gates.

### Absolute Maximum Ratings<sup>(1)(2)</sup>

|                                      |                  |                                       |
|--------------------------------------|------------------|---------------------------------------|
| ESD Tolerance                        | Human Body Model | 2000V                                 |
|                                      | Machine Model    | 200V                                  |
| Supply Voltage                       |                  | 5.8V                                  |
| Common-Mode Input Voltage            |                  | $-0.3 \leq V_{CM} \leq V_{CC} + 0.3V$ |
| Lead Temperature (soldering 10 sec.) |                  | +300°C                                |
| Differential Input Voltage           |                  | ±Supply Voltage                       |
| Current at Input Pin                 |                  | 30 mA                                 |
| Current at Output Pin                |                  | 30 mA                                 |
| Current at Power Supply Pin          |                  | 50 mA                                 |

- (1) Absolute Maximum Ratings indicate limits beyond which damage may occur. Operating Ratings indicate conditions for which the device is intended to be functional, but specific performance is not ensured. For ensured specifications and test conditions, see the Electrical Characteristics.
- (2) If Military/Aerospace specified devices are required, please contact the TI Sales Office/ Distributors for availability and specifications.

### Operating Ratings<sup>(1)</sup>

|                             |                       |                |
|-----------------------------|-----------------------|----------------|
| Supply Voltage              |                       | 2.7V to 5.25V  |
| Storage Temperature Range   |                       | -65°C to 150°C |
| Operating Temperature Range | LMP2014MT, LMP2014MTX | 0°C to 70°C    |

- (1) Absolute Maximum Ratings indicate limits beyond which damage may occur. Operating Ratings indicate conditions for which the device is intended to be functional, but specific performance is not ensured. For ensured specifications and test conditions, see the Electrical Characteristics.

### 2.7V DC Electrical Characteristics

Unless otherwise specified, all limits specified for  $T_J = 25^\circ\text{C}$ ,  $V^+ = 2.7V$ ,  $V^- = 0V$ ,  $V_{CM} = 1.35V$ ,  $V_O = 1.35V$  and  $R_L > 1\text{ M}\Omega$ .

**Boldface** limits apply at the temperature extremes.

| Symbol     | Parameter                     | Conditions  | Min <sup>(1)</sup>     | Typ <sup>(2)</sup> | Max <sup>(1)</sup>     | Units                        |
|------------|-------------------------------|---|------------------------|--------------------|------------------------|------------------------------|
| $V_{OS}$   | Input Offset Voltage          |   |                        | 0.8                | <b>30</b><br><b>60</b> | $\mu\text{V}$                |
|            | Offset Calibration Time       |   |                        | 0.5                | <b>10</b><br><b>12</b> | ms                           |
| $TCV_{OS}$ | Input Offset Voltage          |   |                        | 0.015              |                        | $\mu\text{V}/^\circ\text{C}$ |
|            | Long-Term Offset Drift        |   |                        | 0.006              |                        | $\mu\text{V}/\text{month}$   |
|            | Lifetime $V_{OS}$ Drift       |   |                        | 2.5                |                        | $\mu\text{V}$                |
| $I_{IN}$   | Input Current                 |   |                        | -3                 |                        | pA                           |
| $I_{OS}$   | Input Offset Current          |   |                        | 6                  |                        | pA                           |
| $R_{IND}$  | Input Differential Resistance |   |                        | 9                  |                        | $\text{M}\Omega$             |
| CMRR       | Common Mode Rejection Ratio   | $-0.3 \leq V_{CM} \leq 0.9V$<br>$0 \leq V_{CM} \leq 0.9V$ | <b>95</b><br><b>90</b> | 130                |                        | dB                           |
| PSRR       | Power Supply Rejection Ratio  |   | <b>95</b><br><b>90</b> | 120                |                        | dB                           |
| $A_{VOL}$  | Open Loop Voltage Gain        | $R_L = 10\text{ k}\Omega$                                 | <b>95</b><br><b>90</b> | 130                |                        | dB                           |
|            |                               | $R_L = 2\text{ k}\Omega$                                  | <b>90</b><br><b>85</b> | 124                |                        |                              |

- (1) Limits are 100% production tested at 25°C. Limits over the operating temperature range are specified through correlations using statistical quality control (SQC) method.
- (2) Typical values represent the most likely parametric norm.

## 2.7V DC Electrical Characteristics (continued)

Unless otherwise specified, all limits specified for  $T_J = 25^\circ\text{C}$ ,  $V^+ = 2.7\text{V}$ ,  $V^- = 0\text{V}$ ,  $V_{\text{CM}} = 1.35\text{V}$ ,  $V_O = 1.35\text{V}$  and  $R_L > 1\text{M}\Omega$ . **Boldface** limits apply at the temperature extremes.

| Symbol | Parameter                  | Conditions   | Min <sup>(1)</sup> | Typ <sup>(2)</sup> | Max <sup>(1)</sup>  | Units |
|--------|----------------------------|--|--------------------|--------------------|---------------------|-------|
| $V_O$  | Output Swing               | $R_L = 10\text{ k}\Omega$ to $1.35\text{V}$<br>$V_{\text{IN(diff)}} = \pm 0.5\text{V}$ | 2.63               | 2.68               |                     | V     |
|        |                            |  | <b>2.655</b>       |                    | 0.033               |       |
|        |                            | $R_L = 2\text{ k}\Omega$ to $1.35\text{V}$<br>$V_{\text{IN(diff)}} = \pm 0.5\text{V}$  | 2.615              | 2.65               |                     | V     |
|        |                            |  | <b>2.615</b>       |                    | 0.061               |       |
| $I_O$  | Output Current             | Sourcing, $V_O = 0\text{V}$<br>$V_{\text{IN(diff)}} = \pm 0.5\text{V}$                 | 5                  | 12                 |                     | mA    |
|        |                            | Sinking, $V_O = 5\text{V}$<br>$V_{\text{IN(diff)}} = \pm 0.5\text{V}$                  | 5                  | 18                 |                     |       |
|        |                            |  | <b>3</b>           |                    |                     |       |
|        |                            |  | <b>3</b>           |                    |                     |       |
| $I_S$  | Supply Current per Channel |  |                    | 0.919              | 1.20<br><b>1.50</b> | mA    |

## 2.7V AC Electrical Characteristics

$T_J = 25^\circ\text{C}$ ,  $V^+ = 2.7\text{V}$ ,  $V^- = 0\text{V}$ ,  $V_{\text{CM}} = 1.35\text{V}$ ,  $V_O = 1.35\text{V}$ , and  $R_L > 1\text{M}\Omega$ . **Boldface** limits apply at the temperature extremes.

| Symbol            | Parameter                    | Conditions                      | Min <sup>(1)</sup> | Typ <sup>(2)</sup> | Max <sup>(1)</sup> | Units                  |
|-------------------|------------------------------|---------------------------------|--------------------|--------------------|--------------------|------------------------|
| GBW               | Gain-Bandwidth Product       |                                 |                    | 3                  |                    | MHz                    |
| SR                | Slew Rate                    |                                 |                    | 4                  |                    | V/ $\mu\text{s}$       |
| $\theta_m$        | Phase Margin                 |                                 |                    | 60                 |                    | Deg                    |
| $G_m$             | Gain Margin                  |                                 |                    | -14                |                    | dB                     |
| $e_n$             | Input-Referred Voltage Noise |                                 |                    | 35                 |                    | nV/ $\sqrt{\text{Hz}}$ |
| $i_n$             | Input-Referred Current Noise |                                 |                    |                    |                    | pA/ $\sqrt{\text{Hz}}$ |
| $e_{n\text{p-p}}$ | Input-Referred Voltage Noise | $R_S = 100\Omega$ , DC to 10 Hz |                    | 850                |                    | nV <sub>pp</sub>       |
| $t_{\text{rec}}$  | Input Overload Recovery Time |                                 |                    | 50                 |                    | ms                     |

- (1) Limits are 100% production tested at  $25^\circ\text{C}$ . Limits over the operating temperature range are specified through correlations using statistical quality control (SQC) method.
- (2) Typical values represent the most likely parametric norm.

## 5V DC Electrical Characteristics

Unless otherwise specified, all limits specified for  $T_J = 25^\circ\text{C}$ ,  $V^+ = 5\text{V}$ ,  $V^- = 0\text{V}$ ,  $V_{\text{CM}} = 2.5\text{V}$ ,  $V_O = 2.5\text{V}$  and  $R_L > 1\text{M}\Omega$ . **Boldface** limits apply at the temperature extremes.

| Symbol            | Parameter                      | Conditions  | Min <sup>(1)</sup> | Typ <sup>(2)</sup> | Max <sup>(1)</sup> | Units                        |
|-------------------|--------------------------------|---|--------------------|--------------------|--------------------|------------------------------|
| $V_{\text{OS}}$   | Input Offset Voltage           |   |                    | 0.12               | 30<br><b>60</b>    | $\mu\text{V}$                |
|                   | Offset Calibration Time        |   |                    | 0.5                | 10<br><b>12</b>    | ms                           |
| TCV <sub>OS</sub> | Input Offset Voltage           |   |                    | 0.015              |                    | $\mu\text{V}/^\circ\text{C}$ |
|                   | Long-Term Offset Drift         |   |                    | 0.006              |                    | $\mu\text{V}/\text{month}$   |
|                   | Lifetime $V_{\text{OS}}$ Drift |   |                    | 2.5                |                    | $\mu\text{V}$                |
| $I_{\text{IN}}$   | Input Current                  |   |                    | -3                 |                    | pA                           |
| $I_{\text{OS}}$   | Input Offset Current           |   |                    | 6                  |                    | pA                           |
| $R_{\text{IND}}$  | Input Differential Resistance  |   |                    | 9                  |                    | M $\Omega$                   |
| CMRR              | Common Mode Rejection Ratio    | $-0.3 \leq V_{\text{CM}} \leq 3.2$<br>$0 \leq V_{\text{CM}} \leq 3.2$ | 100<br><b>90</b>   | 130                |                    | dB                           |

- (1) Limits are 100% production tested at  $25^\circ\text{C}$ . Limits over the operating temperature range are specified through correlations using statistical quality control (SQC) method.
- (2) Typical values represent the most likely parametric norm.

### 5V DC Electrical Characteristics (continued)

Unless otherwise specified, all limits specified for  $T_J = 25^\circ\text{C}$ ,  $V^+ = 5\text{V}$ ,  $V^- = 0\text{V}$ ,  $V_{\text{CM}} = 2.5\text{V}$ ,  $V_O = 2.5\text{V}$  and  $R_L > 1\text{M}\Omega$ .

**Boldface** limits apply at the temperature extremes.

| Symbol           | Parameter                    | Conditions  | Min <sup>(1)</sup>    | Typ <sup>(2)</sup> | Max <sup>(1)</sup>    | Units |
|------------------|------------------------------|---|-----------------------|--------------------|-----------------------|-------|
| PSRR             | Power Supply Rejection Ratio |   | 95<br><b>90</b>       | 120                |                       | dB    |
| $A_{\text{VOL}}$ | Open Loop Voltage Gain       | $R_L = 10\text{ k}\Omega$   | 105<br><b>100</b>     | 130                |                       | dB    |
|                  |                              | $R_L = 2\text{ k}\Omega$  | 95<br><b>90</b>       | 132                |                       |       |
| $V_O$            | Output Swing                 | $R_L = 10\text{ k}\Omega$ to 2.5V<br>$V_{\text{IN}}(\text{diff}) = \pm 0.5\text{V}$ | 4.92<br><b>4.95</b>   | 4.978              |                       | V     |
|                  |                              |   |                       | 0.040              | 0.080<br><b>0.085</b> |       |
|                  |                              | $R_L = 2\text{ k}\Omega$ to 2.5V<br>$V_{\text{IN}}(\text{diff}) = \pm 0.5\text{V}$  | 4.875<br><b>4.875</b> | 4.919              |                       | V     |
|                  |                              |   |                       | 0.091              | 0.125<br><b>0.140</b> |       |
| $I_O$            | Output Current               | Sourcing, $V_O = 0\text{V}$<br>$V_{\text{IN}}(\text{diff}) = \pm 0.5\text{V}$       | 8<br><b>6</b>         | 15                 |                       | mA    |
|                  |                              | Sinking, $V_O = 5\text{V}$<br>$V_{\text{IN}}(\text{diff}) = \pm 0.5\text{V}$        | 8<br><b>6</b>         | 17                 |                       |       |
| $I_S$            | Supply Current per Channel   |   |                       | 0.930              | 1.20<br><b>1.50</b>   | mA    |

### 5V AC Electrical Characteristics

$T_J = 25^\circ\text{C}$ ,  $V^+ = 5\text{V}$ ,  $V^- = 0\text{V}$ ,  $V_{\text{CM}} = 2.5\text{V}$ ,  $V_O = 2.5\text{V}$ , and  $R_L > 1\text{M}\Omega$ . **Boldface** limits apply at the temperature extremes.

| Symbol             | Parameter                    | Conditions                      | Min <sup>(1)</sup> | Typ <sup>(2)</sup> | Max <sup>(1)</sup> | Units                  |
|--------------------|------------------------------|---------------------------------|--------------------|--------------------|--------------------|------------------------|
| GBW                | Gain-Bandwidth Product       |                                 |                    | 3                  |                    | MHz                    |
| SR                 | Slew Rate                    |                                 |                    | 4                  |                    | V/ $\mu\text{s}$       |
| $\theta_m$         | Phase Margin                 |                                 |                    | 60                 |                    | deg                    |
| $G_m$              | Gain Margin                  |                                 |                    | -15                |                    | dB                     |
| $e_n$              | Input-Referred Voltage Noise |                                 |                    | 35                 |                    | nV/ $\sqrt{\text{Hz}}$ |
| $i_n$              | Input-Referred Current Noise |                                 |                    |                    |                    | pA/ $\sqrt{\text{Hz}}$ |
| $e_{\text{n,p-p}}$ | Input-Referred Voltage Noise | $R_S = 100\Omega$ , DC to 10 Hz |                    | 850                |                    | nV <sub>PP</sub>       |
| $t_{\text{rec}}$   | Input Overload Recovery Time |                                 |                    | 50                 |                    | ms                     |

- (1) Limits are 100% production tested at 25°C. Limits over the operating temperature range are specified through correlations using statistical quality control (SQC) method.
- (2) Typical values represent the most likely parametric norm.

### Typical Performance Characteristics

$T_A=25^\circ\text{C}$ ,  $V_S=5\text{V}$  unless otherwise specified.

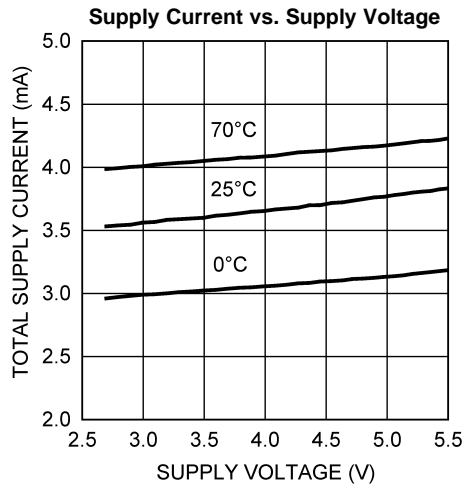

Figure 2.

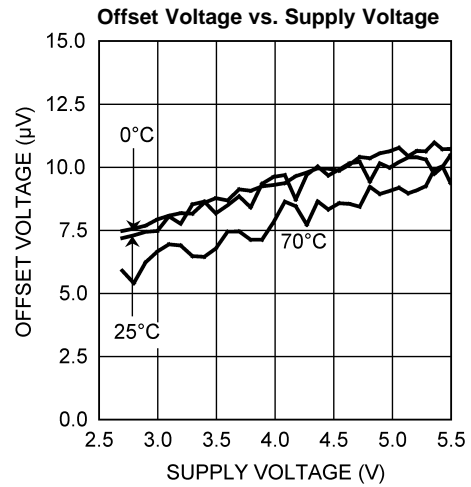

Figure 3.

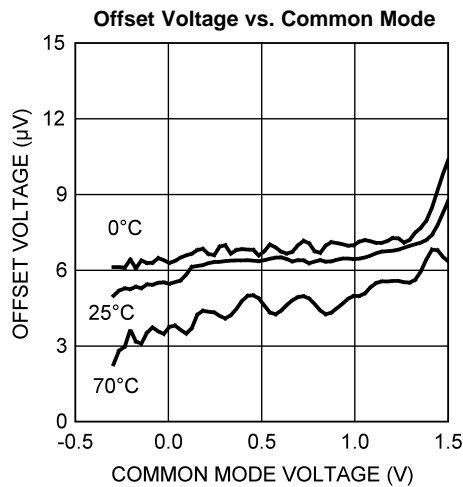

Figure 4.

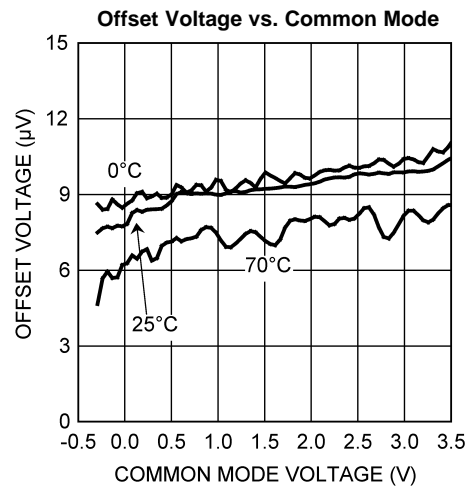

Figure 5.

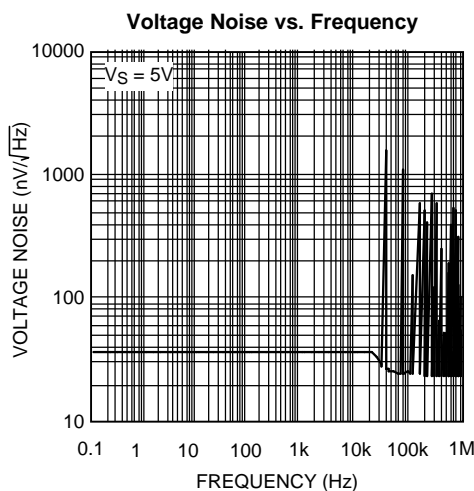

Figure 6.

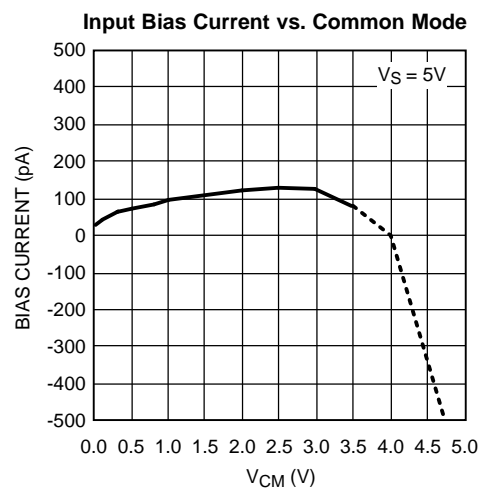
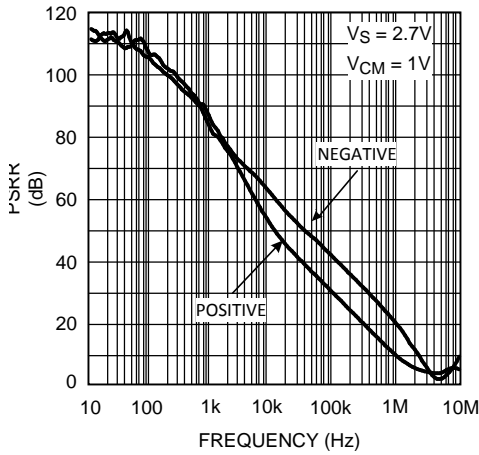

Figure 7.

**Typical Performance Characteristics (continued)**

$T_A=25^{\circ}\text{C}$ ,  $V_S= 5\text{V}$  unless otherwise specified.

**PSRR vs. Frequency**



**Figure 8.**

**PSRR vs. Frequency**

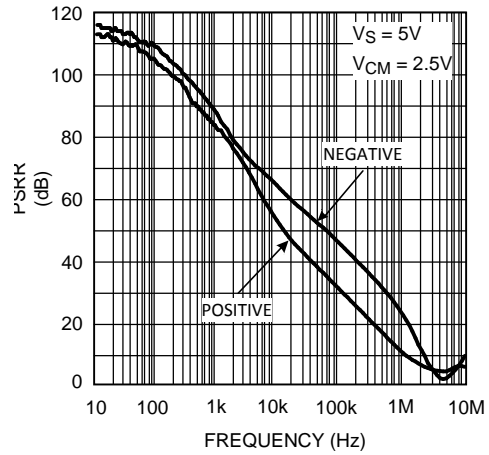

**Figure 9.**

**Output Sourcing @ 2.7V**

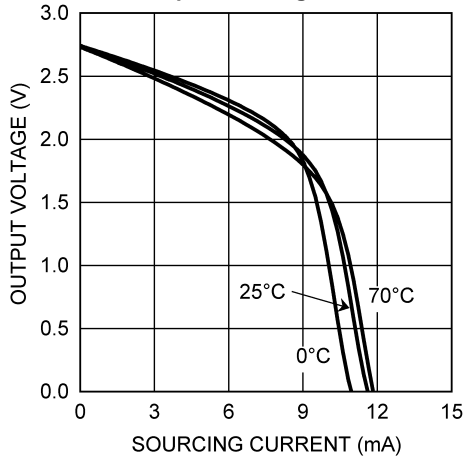

**Figure 10.**

**Output Sourcing @ 5V**

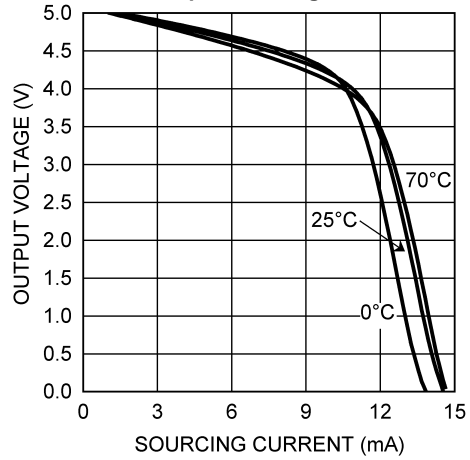

**Figure 11.**

**Output Sinking @ 2.7V**

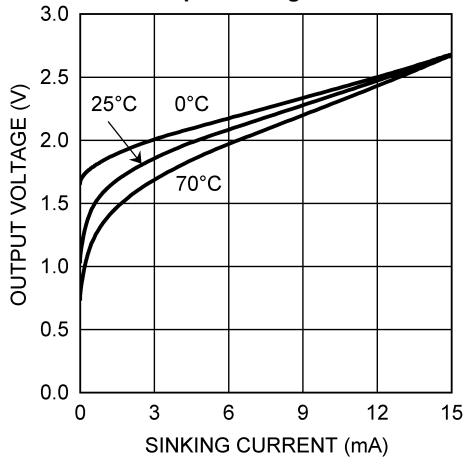

**Figure 12.**

**Output Sinking @ 5V**

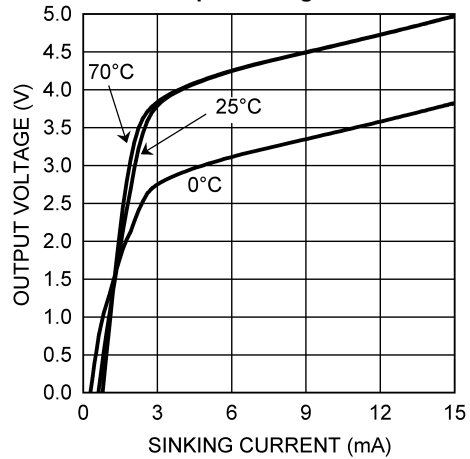

**Figure 13.**

Typical Performance Characteristics (continued)

$T_A=25^\circ\text{C}$ ,  $V_S=5\text{V}$  unless otherwise specified.

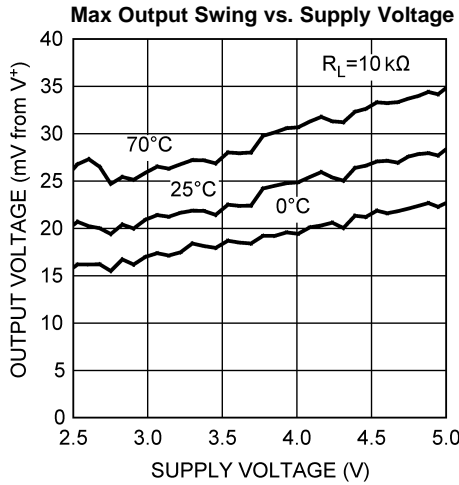

Figure 14.

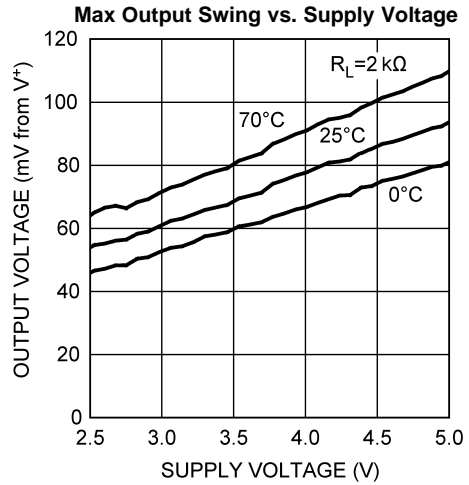

Figure 15.

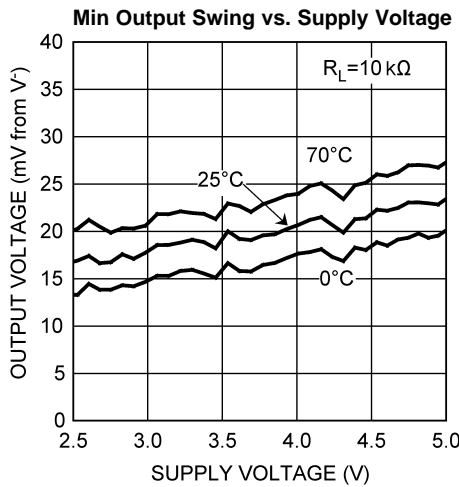

Figure 16.

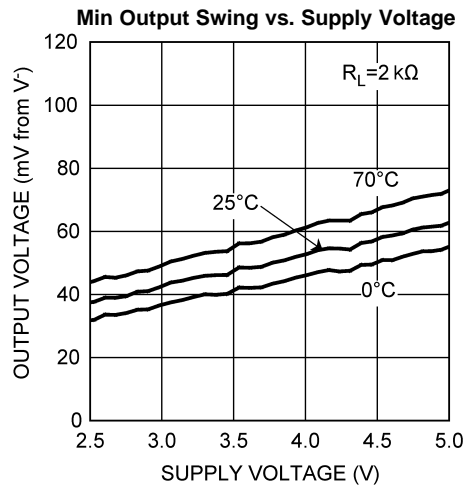

Figure 17.

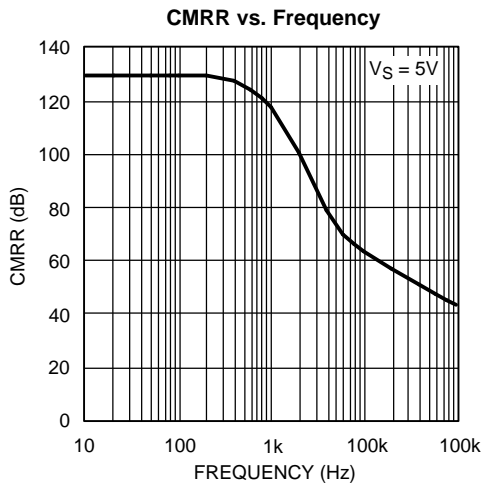

Figure 18.

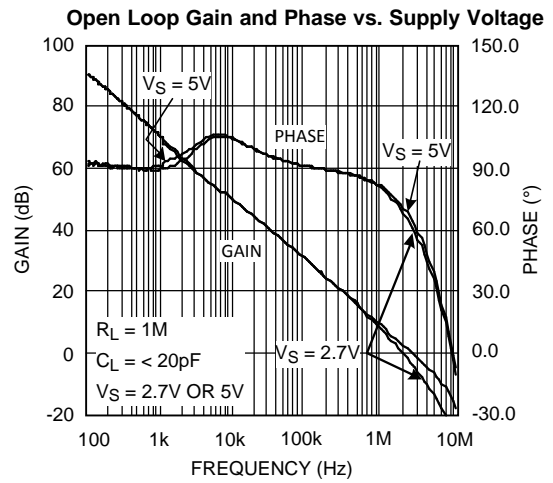

Figure 19.

**Typical Performance Characteristics (continued)**

$T_A=25^{\circ}\text{C}$ ,  $V_S=5\text{V}$  unless otherwise specified.

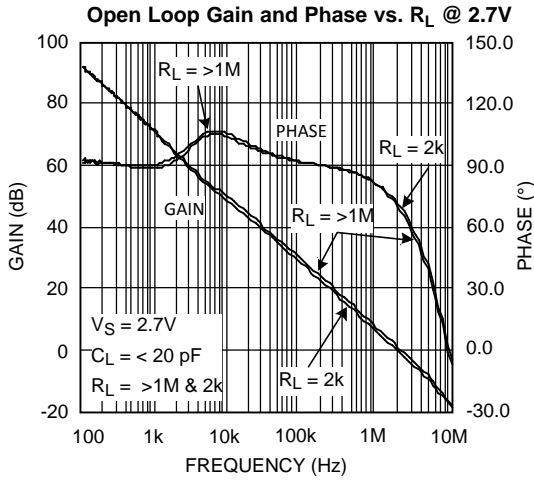

Figure 20.

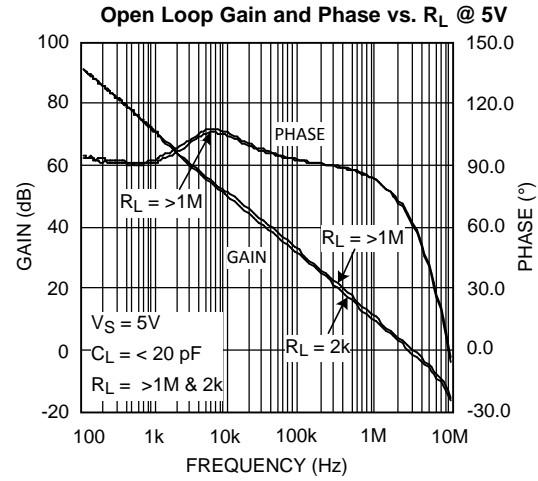

Figure 21.

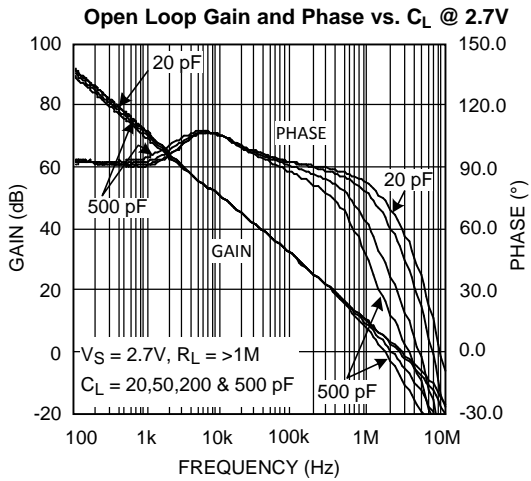

Figure 22.

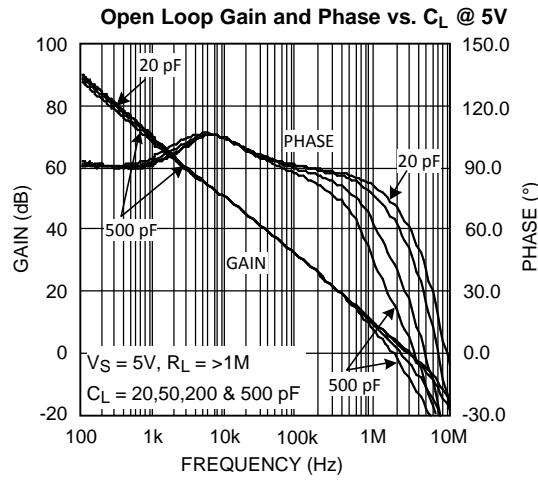

Figure 23.

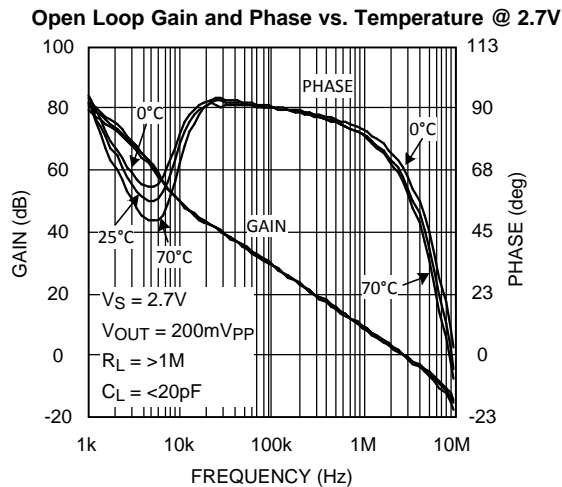

Figure 24.

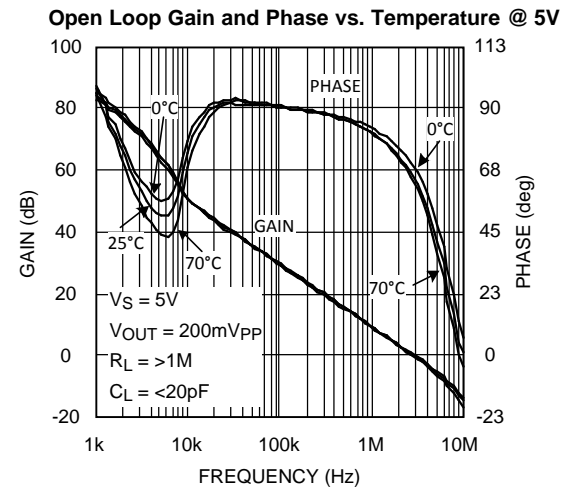

Figure 25.

Typical Performance Characteristics (continued)

T<sub>A</sub>=25°C, V<sub>S</sub>= 5V unless otherwise specified.

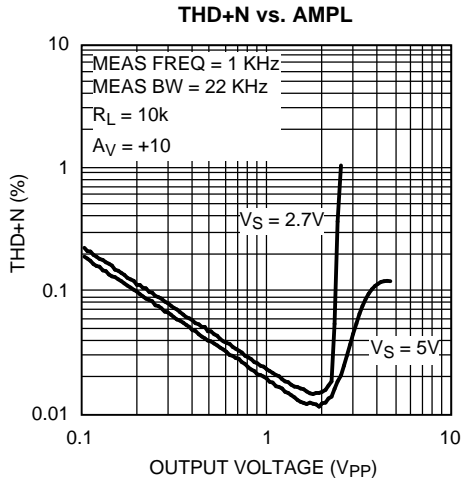

Figure 26.

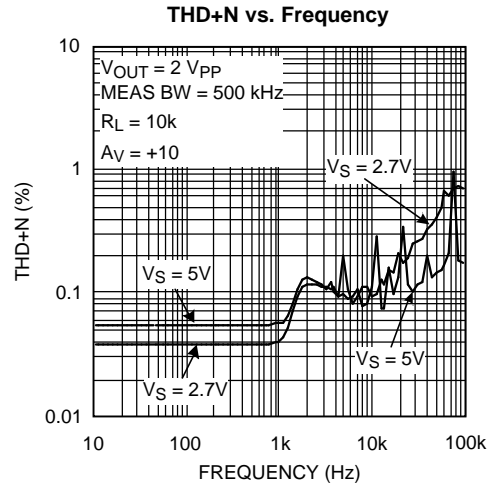

Figure 27.

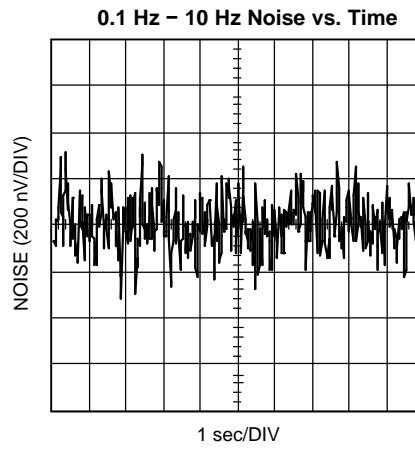

Figure 28.

## APPLICATION INFORMATION

### THE BENEFITS OF LMP2014 NO 1/f NOISE

Using patented methods, the LMP2014 eliminates the 1/f noise present in other amplifiers. That noise, which increases as frequency decreases, is a major source of measurement error in all DC-coupled measurements. Low-frequency noise appears as a constantly-changing signal in series with any measurement being made. As a result, even when the measurement is made rapidly, this constantly-changing noise signal will corrupt the result. The value of this noise signal can be surprisingly large. For example: If a conventional amplifier has a flat-band noise level of  $10\text{nV}/\sqrt{\text{Hz}}$  and a noise corner of 10 Hz, the RMS noise at 0.001 Hz is  $1\mu\text{V}/\sqrt{\text{Hz}}$ . This is equivalent to a 0.50  $\mu\text{V}$  peak-to-peak error, in the frequency range 0.001 Hz to 1.0 Hz. In a circuit with a gain of 1000, this produces a 0.50 mV peak-to-peak output error. This number of 0.001 Hz might appear unreasonably low, but when a data acquisition system is operating for 17 minutes, it has been on long enough to include this error. In this same time, the LMP2014 will only have a 0.21 mV output error. This is smaller by 2.4 x. Keep in mind that this 1/f error gets even larger at lower frequencies. At the extreme, many people try to reduce this error by integrating or taking several samples of the same signal. This is also doomed to failure because the 1/f nature of this noise means that taking longer samples just moves the measurement into lower frequencies where the noise level is even higher.

The LMP2014 eliminates this source of error. The noise level is constant with frequency so that reducing the bandwidth reduces the errors caused by noise.

Another source of error that is rarely mentioned is the error voltage caused by the inadvertent thermocouples created when the common "Kovar type" IC package lead materials are soldered to a copper printed circuit board. These steel-based leadframe materials can produce over 35  $\mu\text{V}/^\circ\text{C}$  when soldered onto a copper trace. This can result in thermocouple noise that is equal to the LMP2014 noise when there is a temperature difference of only 0.0014 $^\circ\text{C}$  between the lead and the board!

For this reason, the lead-frame of the LMP2014 is made of copper. This results in equal and opposite junctions which cancel this effect.

### OVERLOAD RECOVERY

The LMP2014 recovers from input overload much faster than most chopper-stabilized op amps. Recovery from driving the amplifier to 2X the full scale output, only requires about 40 ms. Many chopper-stabilized amplifiers will take from 250 ms to several seconds to recover from this same overload. This is because large capacitors are used to store the unadjusted offset voltage.

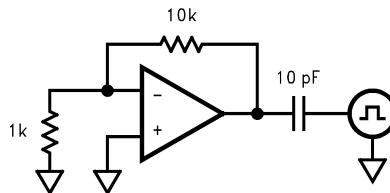

Figure 29.

The wide bandwidth of the LMP2014 enhances performance when it is used as an amplifier to drive loads that inject transients back into the output. ADCs (Analog-to-Digital Converters) and multiplexers are examples of this type of load. To simulate this type of load, a pulse generator producing a 1V peak square wave was connected to the output through a 10 pF capacitor. (Figure 29) The typical time for the output to recover to 1% of the applied pulse is 80 ns. To recover to 0.1% requires 860ns. This rapid recovery is due to the wide bandwidth of the output stage and large total GBW.

### NO EXTERNAL CAPACITORS REQUIRED

The LMP2014 does not need external capacitors. This eliminates the problems caused by capacitor leakage and dielectric absorption, which can cause delays of several seconds from turn-on until the amplifier's error has settled.

**MORE BENEFITS**

The LMP2014 offers the benefits mentioned above and more. It has a rail-to-rail output and consumes only 950  $\mu$ A of supply current while providing excellent DC and AC electrical performance. In DC performance, the LMP2014 achieves 130 dB of CMRR, 120 dB of PSRR and 130 dB of open loop gain. In AC performance, the LMP2014 provides 3 MHz of gain-bandwidth product and 4 V/ $\mu$ s of slew rate.

**HOW THE LMP2014 WORKS**

The LMP2014 uses new, patented techniques to achieve the high DC accuracy traditionally associated with chopper-stabilized amplifiers without the major drawbacks produced by chopping. The LMP2014 continuously monitors the input offset and corrects this error. The conventional chopping process produces many mixing products, both sums and differences, between the chopping frequency and the incoming signal frequency. This mixing causes large amounts of distortion, particularly when the signal frequency approaches the chopping frequency. Even without an incoming signal, the chopper harmonics mix with each other to produce even more trash. If this sounds unlikely or difficult to understand, look at the plot (Figure 30), of the output of a typical (MAX432) chopper-stabilized op amp. This is the output when there is no incoming signal, just the amplifier in a gain of -10 with the input grounded. The chopper is operating at about 150 Hz; the rest is mixing products. Add an input signal and the noise gets much worse. Compare this plot with Figure 31 of the LMP2014. This data was taken under the exact same conditions. The auto-zero action is visible at about 30 kHz but note the absence of mixing products at other frequencies. As a result, the LMP2014 has very low distortion of 0.02% and very low mixing products.

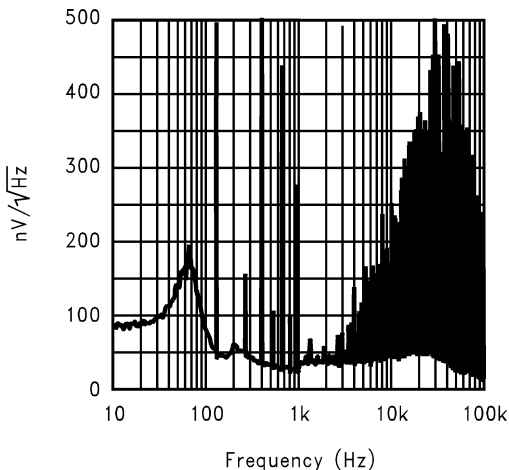

**Figure 30.**

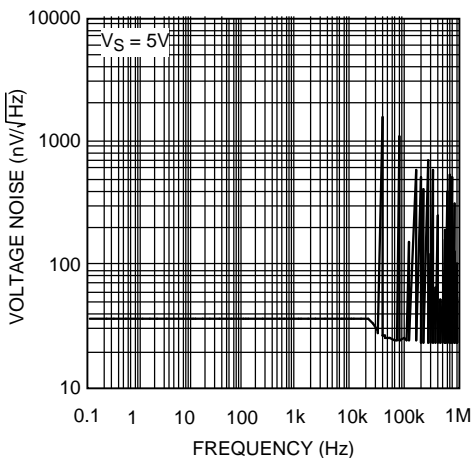

**Figure 31.**

## INPUT CURRENTS

The LMP2014's input currents are different than standard bipolar or CMOS input currents in that it appears as a current flowing in one input and out the other. Under most operating conditions, these currents are in the picoamp level and will have little or no effect in most circuits. These currents tend to increase slightly when the common-mode voltage is near the minus supply. (See the [typical curves](#).) At high temperatures such as 70°C, the input currents become larger, 0.5 nA typical, and are both positive except when the  $V_{CM}$  is near  $V^-$ . If operation is expected at low common-mode voltages and high temperature, do not add resistance in series with the inputs to balance the impedances. Doing this can cause an increase in offset voltage. A small resistance such as 1 k $\Omega$  can provide some protection against very large transients or overloads, and will not increase the offset significantly.

## PRECISION STRAIN-GAUGE AMPLIFIER

This Strain-Gauge amplifier ([Figure 32](#)) provides high gain (1006 or ~60 dB) with very low offset and drift. Using the resistors' tolerances as shown, the worst case CMRR will be greater than 108 dB. The CMRR is directly related to the resistor mismatch. The rejection of common-mode error, at the output, is independent of the differential gain, which is set by R3. The CMRR is further improved, if the resistor ratio matching is improved, by specifying tighter-tolerance resistors, or by trimming.

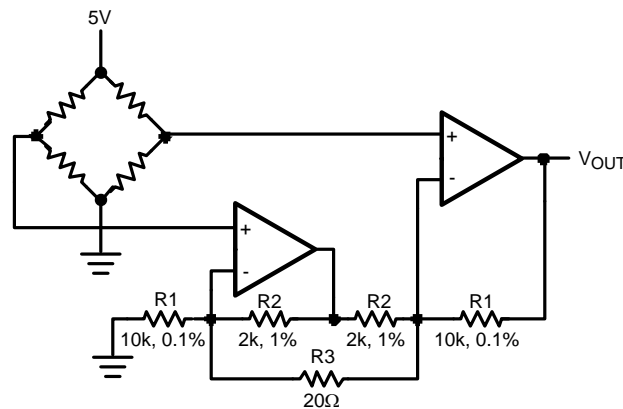

**Figure 32.**

### Extending Supply Voltages and Output Swing by Using a Composite Amplifier Configuration:

In cases where substantially higher output swing is required with higher supply voltages, arrangements like the ones shown in [Figure 33](#) and [Figure 34](#) could be used. These configurations utilize the excellent DC performance of the LMP2014 while at the same time allow the superior voltage and frequency capabilities of the LM6171 to set the dynamic performance of the overall amplifier. For example, it is possible to achieve  $\pm 12V$  output swing with 300 MHz of overall GBW ( $A_V = 100$ ) while keeping the worst case output shift due to  $V_{OS}$  less than 4 mV. The LMP2014 output voltage is kept at about mid-point of its overall supply voltage, and its input common mode voltage range allows the V- terminal to be grounded in one case ([Figure 33](#), inverting operation) and tied to a small non-critical negative bias in another ([Figure 34](#), non-inverting operation). Higher closed-loop gains are also possible with a corresponding reduction in realizable bandwidth. [Table 1](#) shows some other closed loop gain possibilities along with the measured performance in each case.

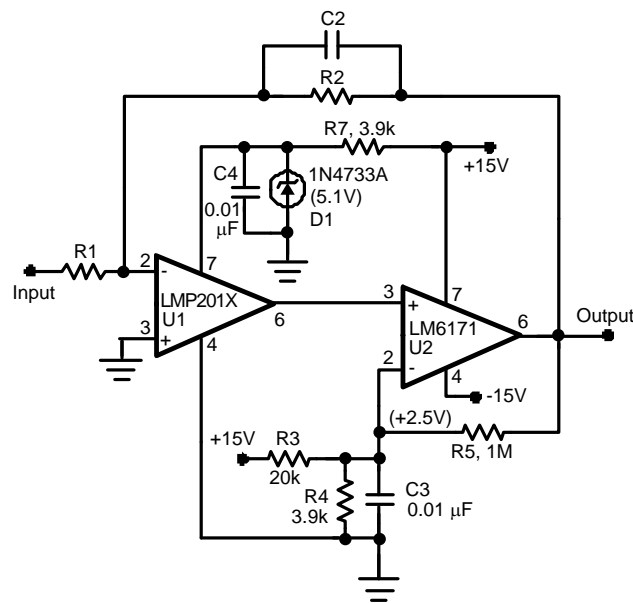

Figure 33.

Table 1. Composite Amplifier Measured Performance

| AV   | R1<br>Ω | R2<br>Ω | C2<br>pF | BW<br>MHz | SR<br>(V/μs) | en p-p<br>(mV <sub>pp</sub> ) |
|------|---------|---------|----------|-----------|--------------|-------------------------------|
| 50   | 200     | 10k     | 8        | 3.3       | 178          | 37                            |
| 100  | 100     | 10k     | 10       | 2.5       | 174          | 70                            |
| 100  | 1k      | 100k    | 0.67     | 3.1       | 170          | 70                            |
| 500  | 200     | 100k    | 1.75     | 1.4       | 96           | 250                           |
| 1000 | 100     | 100k    | 2.2      | 0.98      | 64           | 400                           |

In terms of the measured output peak-to-peak noise, the following relationship holds between output noise voltage,  $e_n$  p-p, for different closed-loop gain,  $A_V$ , settings, where  $-3$  dB Bandwidth is BW:

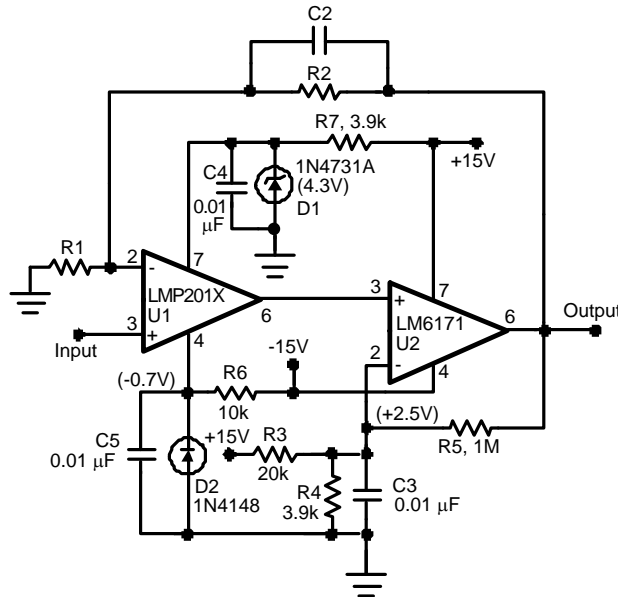

Figure 34.

It should be kept in mind that in order to minimize the output noise voltage for a given closed-loop gain setting, one could minimize the overall bandwidth. As can be seen from Equation 1 above, the output noise has a square-root relationship to the Bandwidth.

In the case of the inverting configuration, it is also possible to increase the input impedance of the overall amplifier, by raising the value of R1, without having to increase the feed-back resistor, R2, to impractical values, by utilizing a "Tee" network as feedback. See the [LMC6442 Data Sheet](#) (Application Notes section) for more details on this.

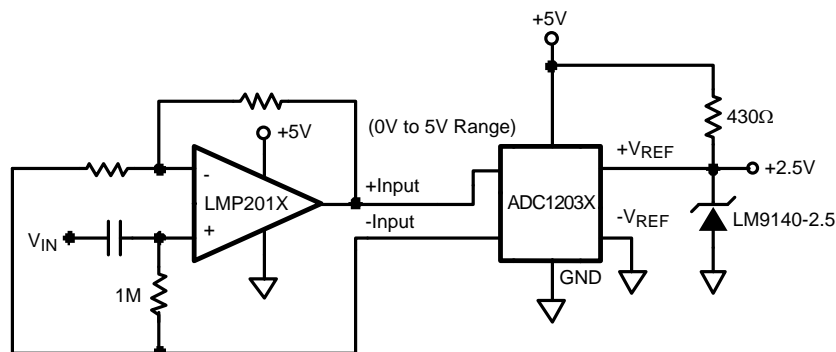

Figure 35.

## LMP2014 AS ADC INPUT AMPLIFIER

The LMP2014 is a great choice for an amplifier stage immediately before the input of an ADC (Analog-to-Digital Converter), whether AC or DC coupled. See [Figure 35](#) and [Figure 36](#). This is because of the following important characteristics:

- Very low offset voltage and offset voltage drift over time and temperature allow a high closed-loop gain setting without introducing any short-term or long-term errors. For example, when set to a closed-loop gain of 100 as the analog input amplifier for a 12-bit A/D converter, the overall conversion error over full operation temperature and 30 years life of the part (operating at 50°C) would be less than 5 LSBs.
- Fast large-signal settling time to 0.01% of final value (1.4  $\mu$ s) allows 12 bit accuracy at 100 KHz or more sampling rate.
- No flicker (1/f) noise means unsurpassed data accuracy over any measurement period of time, no matter how long. Consider the following op amp performance, based on a typical low-noise, high-performance commercially-available device, for comparison:

$$\text{Op amp flatband noise} = 8\text{nV}/\sqrt{\text{Hz}}$$

$$1/f \text{ corner frequency} = 100 \text{ Hz}$$

$$A_V = 2000$$

$$\text{Measurement time} = 100 \text{ sec}$$

$$\text{Bandwidth} = 2 \text{ Hz}$$

This example will result in about 2.2 mV<sub>PP</sub> (1.9 LSB) of output noise contribution due to the op amp alone, compared to about 594  $\mu$ V<sub>PP</sub> (less than 0.5 LSB) when that op amp is replaced with the LMP2014 which has no 1/f contribution. If the measurement time is increased from 100 seconds to 1 hour, the improvement realized by using the LMP2014 would be a factor of about 4.8 times (2.86 mV<sub>PP</sub> compared to 596  $\mu$ V when LMP2014 is used) mainly because the LMP2014 accuracy is not compromised by increasing the observation time.

- Copper leadframe construction minimizes any thermocouple effects which would degrade low level/high gain data conversion application accuracy (see discussion under "[The Benefits of the LMP2014](#)" section above).
- Rail-to-Rail output swing maximizes the ADC dynamic range in 5-Volt single-supply converter applications. Below are some typical block diagrams showing the LMP2014 used as an ADC amplifier.

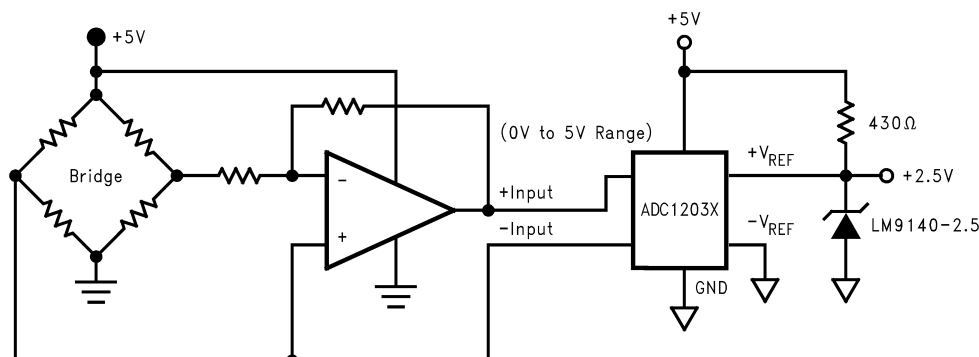



Figure 36.

## REVISION HISTORY

| Changes from Revision A (March 2013) to Revision B         | Page               |
|--|--------------------|
| • Changed layout of National Data Sheet to TI format ..... | <a href="#">15</a> |

**PACKAGING INFORMATION**

| Orderable Device | Status<br>(1) | Package Type | Package Drawing | Pins | Package Qty | Eco Plan<br>(2) | Lead finish/<br>Ball material<br>(6) | MSL Peak Temp<br>(3) | Op Temp (°C) | Device Marking<br>(4/5) | Samples   |
|------------------|---------------|--------------|-----------------|------|-------------|-----------------|--------------------------------------|----------------------|--------------|-------------------------|---|
| LMP2014MT/NOPB   | ACTIVE        | TSSOP        | PW              | 14   | 94          | RoHS & Green    | SN                                   | Level-1-260C-UNLIM   | 0 to 70      | LMP20<br>14MT           |  |
| LMP2014MTX/NOPB  | ACTIVE        | TSSOP        | PW              | 14   | 2500        | RoHS & Green    | SN                                   | Level-1-260C-UNLIM   | 0 to 70      | LMP20<br>14MT           |  |

(1) The marketing status values are defined as follows:

**ACTIVE:** Product device recommended for new designs.

**LIFEBUY:** TI has announced that the device will be discontinued, and a lifetime-buy period is in effect.

**NRND:** Not recommended for new designs. Device is in production to support existing customers, but TI does not recommend using this part in a new design.

**PREVIEW:** Device has been announced but is not in production. Samples may or may not be available.

**OBSOLETE:** TI has discontinued the production of the device.

(2) **RoHS:** TI defines "RoHS" to mean semiconductor products that are compliant with the current EU RoHS requirements for all 10 RoHS substances, including the requirement that RoHS substance do not exceed 0.1% by weight in homogeneous materials. Where designed to be soldered at high temperatures, "RoHS" products are suitable for use in specified lead-free processes. TI may reference these types of products as "Pb-Free".

**RoHS Exempt:** TI defines "RoHS Exempt" to mean products that contain lead but are compliant with EU RoHS pursuant to a specific EU RoHS exemption.

**Green:** TI defines "Green" to mean the content of Chlorine (Cl) and Bromine (Br) based flame retardants meet JS709B low halogen requirements of <=1000ppm threshold. Antimony trioxide based flame retardants must also meet the <=1000ppm threshold requirement.

(3) MSL, Peak Temp. - The Moisture Sensitivity Level rating according to the JEDEC industry standard classifications, and peak solder temperature.

(4) There may be additional marking, which relates to the logo, the lot trace code information, or the environmental category on the device.

(5) Multiple Device Markings will be inside parentheses. Only one Device Marking contained in parentheses and separated by a "~" will appear on a device. If a line is indented then it is a continuation of the previous line and the two combined represent the entire Device Marking for that device.

(6) Lead finish/Ball material - Orderable Devices may have multiple material finish options. Finish options are separated by a vertical ruled line. Lead finish/Ball material values may wrap to two lines if the finish value exceeds the maximum column width.

**Important Information and Disclaimer:**The information provided on this page represents TI's knowledge and belief as of the date that it is provided. TI bases its knowledge and belief on information provided by third parties, and makes no representation or warranty as to the accuracy of such information. Efforts are underway to better integrate information from third parties. TI has taken and continues to take reasonable steps to provide representative and accurate information but may not have conducted destructive testing or chemical analysis on incoming materials and chemicals. TI and TI suppliers consider certain information to be proprietary, and thus CAS numbers and other limited information may not be available for release.

In no event shall TI's liability arising out of such information exceed the total purchase price of the TI part(s) at issue in this document sold by TI to Customer on an annual basis.



**TAPE AND REEL INFORMATION**

**QUADRANT ASSIGNMENTS FOR PIN 1 ORIENTATION IN TAPE**

\*All dimensions are nominal

| Device          | Package Type | Package Drawing | Pins | SPQ  | Reel Diameter (mm) | Reel Width W1 (mm) | A0 (mm) | B0 (mm) | K0 (mm) | P1 (mm) | W (mm) | Pin1 Quadrant |
|-----------------|--------------|-----------------|------|------|--------------------|--------------------|---------|---------|---------|---------|--------|---------------|
| LMP2014MTX/NOPB | TSSOP        | PW              | 14   | 2500 | 330.0              | 12.4               | 6.95    | 5.6     | 1.6     | 8.0     | 12.0   | Q1            |

**TAPE AND REEL BOX DIMENSIONS**

\*All dimensions are nominal

| Device          | Package Type | Package Drawing | Pins | SPQ  | Length (mm) | Width (mm) | Height (mm) |
|-----------------|--------------|-----------------|------|------|-------------|------------|-------------|
| LMP2014MTX/NOPB | TSSOP        | PW              | 14   | 2500 | 853.0       | 449.0      | 35.0        |

**TUBE**

\*All dimensions are nominal

| Device         | Package Name | Package Type | Pins | SPQ | L (mm) | W (mm) | T (μm) | B (mm) |
|----------------|--------------|--------------|------|-----|--------|--------|--------|--------|
| LMP2014MT/NOPB | PW           | TSSOP        | 14   | 94  | 495    | 8      | 2514.6 | 4.06   |



PW (R-PDSO-G14)

PLASTIC SMALL OUTLINE



- NOTES:
- All linear dimensions are in millimeters.
  - This drawing is subject to change without notice.
  - Publication IPC-7351 is recommended for alternate designs.
  - Laser cutting apertures with trapezoidal walls and also rounding corners will offer better paste release. Customers should contact their board assembly site for stencil design recommendations. Refer to IPC-7525 for other stencil recommendations.
  - Customers should contact their board fabrication site for solder mask tolerances between and around signal pads.

## IMPORTANT NOTICE AND DISCLAIMER

TI PROVIDES TECHNICAL AND RELIABILITY DATA (INCLUDING DATA SHEETS), DESIGN RESOURCES (INCLUDING REFERENCE DESIGNS), APPLICATION OR OTHER DESIGN ADVICE, WEB TOOLS, SAFETY INFORMATION, AND OTHER RESOURCES "AS IS" AND WITH ALL FAULTS, AND DISCLAIMS ALL WARRANTIES, EXPRESS AND IMPLIED, INCLUDING WITHOUT LIMITATION ANY IMPLIED WARRANTIES OF MERCHANTABILITY, FITNESS FOR A PARTICULAR PURPOSE OR NON-INFRINGEMENT OF THIRD PARTY INTELLECTUAL PROPERTY RIGHTS.

These resources are intended for skilled developers designing with TI products. You are solely responsible for (1) selecting the appropriate TI products for your application, (2) designing, validating and testing your application, and (3) ensuring your application meets applicable standards, and any other safety, security, regulatory or other requirements.

These resources are subject to change without notice. TI grants you permission to use these resources only for development of an application that uses the TI products described in the resource. Other reproduction and display of these resources is prohibited. No license is granted to any other TI intellectual property right or to any third party intellectual property right. TI disclaims responsibility for, and you will fully indemnify TI and its representatives against, any claims, damages, costs, losses, and liabilities arising out of your use of these resources.

TI's products are provided subject to [TI's Terms of Sale](#) or other applicable terms available either on [ti.com](http://ti.com) or provided in conjunction with such TI products. TI's provision of these resources does not expand or otherwise alter TI's applicable warranties or warranty disclaimers for TI products.

TI objects to and rejects any additional or different terms you may have proposed.

Mailing Address: Texas Instruments, Post Office Box 655303, Dallas, Texas 75265  
Copyright © 2022, Texas Instruments Incorporated