

# OPAx835 超低功耗、轨到轨输出、负电源轨输入、VFB 运算放大器

## 1 特性

- 超低功耗
  - 电源电压：2.5V 至 5.5V
  - 静态电流：250 $\mu$ A/ch (典型值)
  - 断电模式：0.5 $\mu$ A (典型值)
- 带宽：56MHz (AV = 1V/V)
- 压摆率：160V/ $\mu$ s
- 上升时间：10ns (2VSTEP)
- 稳定时间 (0.1%)：55ns (2VSTEP)
- 过驱恢复时间：200ns
- SNR：在 1kHz (1VRMS) 时为 0.00015% (-116.4dBc)
- THD：在 1kHz (1VRMS) 时为 0.00003% (-130dBc)
- HD2/HD3：在 1MHz (2VPP) 时为 -70dBc/-73dBc
- 输入电压噪声：9.3nV/ $\sqrt{\text{Hz}}$  (f = 100kHz)
- 输入失调电压：100 $\mu$ V (最大  $\pm$ 500 $\mu$ V)
- CMRR：113dB
- 输出电流驱动：40mA
- RRO：轨到轨输出
- 输入电压范围：
  - 0.2V 到 3.9V (5V 电源)
- 工作温度范围：
  - 40°C 至 +125°C

## 2 应用

- 低功耗信号调节
- 音频模数转换器 (ADC) 输入缓冲器
- 低功耗 SAR 和  $\Delta \Sigma$  ADC 驱动器
- 便携式系统
- 低功耗系统
- 高密度系统
- 超声波流量计

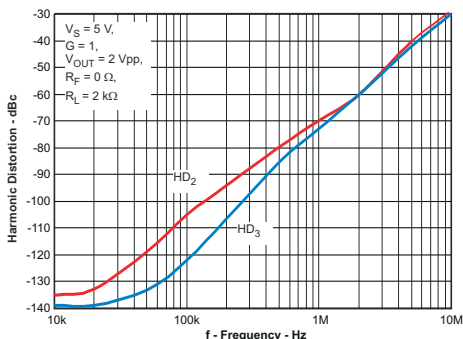

谐波失真与频率间的关系

## 3 说明

OPA835 和 OPA2835 器件 (OPAx835) 是单/双通道超低功耗、轨到轨输出、负电源轨输入、电压反馈 (VFB) 运算放大器, 依设计可由 2.5V 至 5.5V 范围内的单电源或者  $\pm$ 1.25V 至  $\pm$ 2.75V 范围内的双电源供电运行。这些轨到轨放大器每通道仅消耗 250 $\mu$ A 的电流, 单位带宽增益积为 56MHz, 性能/功耗比处于业内领先水平。

OPA835 和 OPA2835 器件同时拥有低功耗特性和出色的高频性能, 并且可提供其他同类器件所无法达到的性能/功耗比, 因此非常适合注重功耗的电池供电类便携式应用。这些器件还具有节能模式, 可将电流降至 1.5 $\mu$ A 以下, 这对于电池供电类应用中的高频放大器而言是极具吸引力的解决方案。

OPA835 RUN 封装选件包含集成的增益设置电阻器, 因此可在印刷电路板上实现尽可能最小的尺寸 (约 2.00mm  $\times$  2.00mm)。通过在 PCB 上添加电路迹线, 可实现 +1、-1、-1.33、+2、+2.33、-3、+4、-4、+5、-5.33、+6.33、-7、+8 的增益和 -0.1429、-0.1875、-0.25、-0.33、-0.75 的反相衰减。有关详细信息, 请参见表 9-1 和表 9-2。

OPA835 和 OPA2835 器件在 -40°C 至 +125°C 的扩展工业温度范围内运行。

### 器件信息<sup>(1)</sup>

器件型号	封装	封装尺寸 (标称值)
OPA835	SOT-23 (6)	2.90mm $\times$ 1.60mm
	QFN (10)	2.00mm $\times$ 2.00mm
OPA2835	SOIC (8)	4.90mm $\times$ 3.91mm
	VSSOP (10)	3.00mm $\times$ 3.00mm
	UQFN (10)	2.00mm $\times$ 2.00mm
	QFN (10)	2.00mm $\times$ 2.00mm

(1) 如需了解所有可用封装, 请参阅数据表末尾的封装选项附录。



## Table of Contents

<b>1 特性</b> .....	1	<b>9 Application and Implementation</b> .....	29
<b>2 应用</b> .....	1	9.1 Application Information.....	29
<b>3 说明</b> .....	1	9.2 Typical Application.....	35
<b>4 Revision History</b> .....	2	<b>10 Power Supply Recommendations</b> .....	39
<b>5 Device Comparison Table</b> .....	4	<b>11 Layout</b> .....	40
<b>6 Pin Configuration and Functions</b> .....	4	11.1 Layout Guidelines.....	40
<b>7 Specifications</b> .....	6	11.2 Layout Example.....	41
7.1 Absolute Maximum Ratings.....	6	<b>12 Device and Documentation Support</b> .....	42
7.2 ESD Ratings.....	6	12.1 Device Support.....	42
7.3 Recommended Operating Conditions.....	6	12.2 Documentation Support.....	42
7.4 Thermal Information: OPA835.....	6	12.3 Related Links.....	42
7.5 Thermal Information: OPA2835.....	7	12.4 Receiving Notification of Documentation Updates.....	42
7.6 Electrical Characteristics: $V_S = 2.7\text{ V}$ .....	7	12.5 支持资源.....	42
7.7 Electrical Characteristics: $V_S = 5\text{ V}$ .....	10	12.6 Trademarks.....	42
<b>8 Detailed Description</b> .....	23	12.7 静电放电警告.....	42
8.1 Overview.....	23	12.8 术语表.....	42
8.2 Functional Block Diagram.....	23	<b>13 Mechanical, Packaging, and Orderable Information</b> .....	42
8.3 Feature Description.....	23		
8.4 Device Functional Modes.....	26		

## 4 Revision History

注：以前版本的页码可能与当前版本的页码不同

<b>Changes from Revision I (August 2016) to Revision J (March 2021)</b>	<b>Page</b>
• 更新了整个文档的表、图和交叉参考的编号格式.....	1
• Changed the input impedance common-mode typical test condition from 200    1.2 k $\Omega$    pF to 250    1.2 M $\Omega$    pF.....	7
• Changed the input impedance common-mode typical test condition from 200    1.2 k $\Omega$    pF to 250    1.2 M $\Omega$    pF.....	10
<b>Changes from Revision H (November 2015) to Revision I (August 2016)</b>	<b>Page</b>
• Reformatted table note on <i>Thermal Information: OPA835</i> and <i>Thermal Information: OPA2835</i> tables.....	6
• Deleted the word "linear" from output voltage low, output voltage high, and output current drive parameters in <i>Electrical Characteristics: <math>V_S = 2.7\text{ V}</math></i> table.....	7
• Changed Current noise 1/f corner frequency parameter units from Hz to kHz in <i>Electrical Characteristics: <math>V_S = 5\text{ V}</math></i> table.....	10
• Deleted the word "linear" from output voltage low, output voltage high, and output current drive parameters in <i>Electrical Characteristics: <math>V_S = 5\text{ V}</math></i> table.....	10
• Reformatted <i>Development Support</i> section.....	42
• Reformatted <i>Related Documentation</i> section.....	42
<b>Changes from Revision G (June 2015) to Revision H (November 2015)</b>	<b>Page</b>
• Changed package designator from DMC to RMC (typo).....	4
• Changed text in first paragraph of <i>Power-Down Operation</i> section.....	24
<b>Changes from Revision F (June 2015) to Revision G (June 2015)</b>	<b>Page</b>
• Moved all switching parameters from the <i>Switching Characteristics: <math>V_S = 2.7\text{ V}</math></i> back into the <i>Electrical Characteristics: <math>V_S = 2.7\text{ V}</math></i> table.....	7
• Moved all switching parameters from the <i>Switching Characteristics: <math>V_S = 5\text{ V}</math></i> table back into the <i>Electrical Characteristics: <math>V_S = 5\text{ V}</math></i> table.....	10

---

**Changes from Revision E (July 2013) to Revision F (June 2015) Page**

- 添加了引脚配置和功能 部分、ESD 等级 表、开关特性 表、特性说明 部分、器件功能模式、应用和实施 部  
分、电源相关建议 部分、布局 部分、器件和文档支持 部分以及机械、封装和可订购信息 部分..... 1
- Moved the switching parameters from the *Electrical Characteristics* tables into *Switching Characteristics*  
tables..... 10

---

**Changes from Revision D (October 2011) to Revision E (July 2013) Page**

- 在文档中增加了 RMC 封装..... 1
- Added RMC to *Thermal Information* table..... 6

---

**Changes from Revision C (September 2011) to Revision D (September 2011) Page**

- Removed Product Preview from OPA835IRUNT and OPA835IRUNR..... 4
- Changed Resistor temperature coefficient typical value from TBD to < 10..... 7
- "Changed Quiescent operating current" parameter to "Quiescent operating current per amplifier"..... 7
- Changed Resistor temperature coefficient parameter units from TBD to < 10..... 10
- Changed Quiescent operating current parameter to Quiescent operating current per amplifier..... 10

---

**Changes from Revision B (May 2011) to Revision C (August 2011) Page**

- Removed Product Preview from all devices except OPA835IRUNT and OPA835IRUNR..... 4
- Changed - Channel to channel crosstalk (OPA2835) typical value from TBD to - 120 dB..... 7
- Changed the Common-mode rejection ratio minimum value from 91 dB to 88 dB..... 7
- Added GAIN-SETTING RESISTORS (OPA835IRUN ONLY) parameter..... 7
- Changed the Quiescent operating current per amplifier( $T_A = 25^\circ\text{C}$ ) parameter minimum value from 190  $\mu\text{A}$  to  
175  $\mu\text{A}$ ..... 7
- Changed the Power supply rejection ( $\pm\text{PSRR}$ ) minimum value from 91 dB to 88 dB..... 7
- Changed the Power-down pin bias current test conditions from  $\overline{\text{PD}} = 0.7 \text{ V}$  to  $\overline{\text{PD}} = 0.5 \text{ V}$ ..... 7
- Changed the Power-down quiescent current test conditions from  $\overline{\text{PD}} = 0.7 \text{ V}$  to  $\overline{\text{PD}} = 0.5 \text{ V}$ ..... 7
- Changed Channel to channel crosstalk (OPA2835) typical value from TBD to -120 dB..... 10
- Changed the common-mode rejection ratio minimum value from 94 dB to 91 dB..... 10
- Added GAIN-SETTING RESISTORS (OPA835IRUN ONLY) parameter..... 10
- Changed the Quiescent operating current ( $T_A = 25^\circ\text{C}$ ) Min value From: 215  $\mu\text{A}$  To: 200  $\mu\text{A}$ ..... 10
- Changed the Power supply rejection ( $\pm\text{PSRR}$ ) minimum value from 93 dB to 90 dB..... 10
- Changed the Power-down quiescent current test conditions from  $\overline{\text{PD}} = 0.7 \text{ V}$  to  $\overline{\text{PD}} = 0.5 \text{ V}$ ..... 10
- Changed the Power-down quiescent current test conditions from  $\overline{\text{PD}} = 0.7 \text{ V}$  to  $\overline{\text{PD}} = 0.5 \text{ V}$ ..... 10
- Added Figure Crosstalk vs Frequency..... 0
- Added Figure Crosstalk vs Frequency..... 0
- Added *Single-Ended to Differential Amplifier* section ..... 30

---

**Changes from Revision A (March 2011) to Revision B (May 2011) Page**

- 已将 OPA835 从“产品预发布”更改为“生产数据” ..... 1
-

## 5 Device Comparison Table

PART NUMBER	BW ( $A_V = 1$ ) MHz	SLEW RATE $V/\mu\text{sec}$	$I_q$ (+5 V) mA	INPUT NOISE $nV/\sqrt{\text{Hz}}$	RAIL-TO-RAIL IN/OUT	DUALS
OPA835	30	110	0.25	9.3	- VS/Out	OPA2835
OPA365	50	25	5	4.5	In/Out	OPA2365
THS4281	95	35	0.75	12.5	In/Out	
LMH6618	140	45	1.25	10	In/Out	LMH6619
OPA836	205	560	1	4.6	- VS/Out	OPA2836
OPA830	310	600	3.9	9.5	- VS/Out	OPA2830

Visit [ti.com](http://ti.com) for a complete selection of TI High Speed Amplifiers.

## 6 Pin Configuration and Functions



图 6-1. OPA835: DBV Package 6-Pin SOT-23 Top View



图 6-2. OPA2835: D Package 8-Pin SOIC Top View

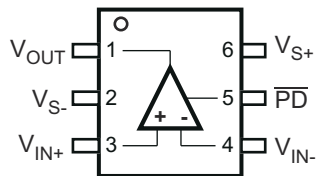

图 6-3. OPA2835: DGS Package 10-Pin VSSOP Top View

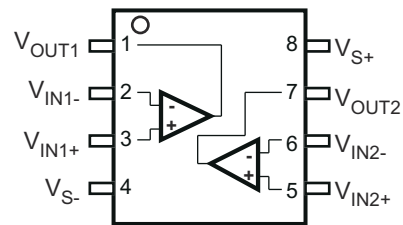

图 6-4. OPA2835: RMC and RUN Packages 10-Pin UQFN and 10-Pin QFN Top View

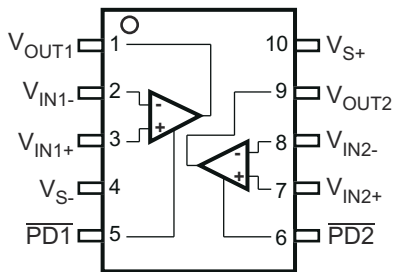

图 6-5. OPA835: RUN Package 10-Pin QFN Top View

**表 6-1. Pin Functions**

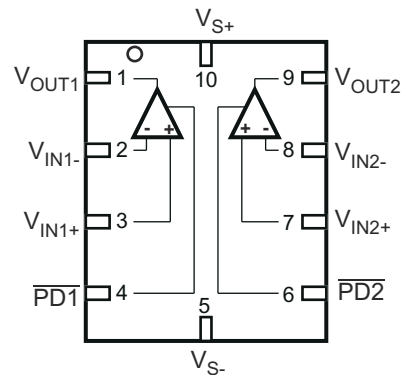
NAME	PIN					I/O	DESCRIPTION			
	OPA835		OPA2835							
	SOT-23	QFN	SOIC	VSSOP	QFN, UQFN					
FB <sub>1</sub>	—	9	—	—	—	I/O	Connection to top of 2.4-k $\Omega$ internal gain-setting resistors			
FB <sub>2</sub>		8				I/O	Connection to junction of 1.8-k $\Omega$ and 2.4-k $\Omega$ internal gain-setting resistors			
FB <sub>3</sub>		7				I/O	Connection to junction of 600- $\Omega$ and 1.8-k $\Omega$ internal gain-setting resistors			
FB <sub>4</sub>		6				I/O	Connection to bottom of 600- $\Omega$ internal gain-setting resistors			
PD		5				4	I	Amplifier Power Down, low = low-power mode, high = normal operation ( <b>PIN MUST BE DRIVEN</b> )		
PD <sub>1</sub>	—	—	5	4	I	Amplifier 1 Power Down, low = low-power mode, high = normal operation ( <b>PIN MUST BE DRIVEN</b> )				
PD <sub>2</sub>	—	—	6	6	I	Amplifier 2 Power Down, low = low-power mode, high = normal operation ( <b>PIN MUST BE DRIVEN</b> )				
V <sub>IN+</sub>	3	3	—	—	—	I	Amplifier noninverting input			
V <sub>IN-</sub>	4	2				I	Amplifier inverting input			
V <sub>IN1+</sub>	—	—				3	3	3	I	Amplifier 1 noninverting input
V <sub>IN1-</sub>						2	2	2	I	Amplifier 1 inverting input
V <sub>IN2+</sub>						5	7	7	I	Amplifier 2 noninverting input
V <sub>IN2-</sub>			6	8	8	I	Amplifier 2 inverting input			
V <sub>OUT</sub>	1	1	—	—	—	O	Amplifier output			
V <sub>OUT1</sub>	—	—	1	1	1	O	Amplifier 1 output			
V <sub>OUT2</sub>			7	9	9	O	Amplifier 2 output			
V <sub>S+</sub>	6	10	8	10	10	POW	Positive power supply input			
V <sub>S-</sub>	2	5	4	4	5	POW	Negative power supply input			

## 7 Specifications

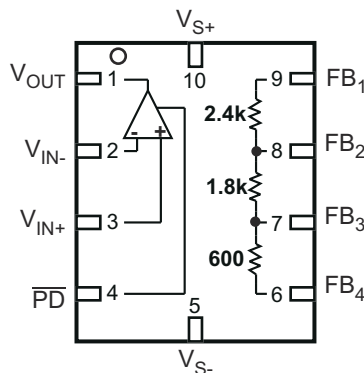
### 7.1 Absolute Maximum Ratings

over operating free-air temperature range (unless otherwise noted)<sup>(1)</sup>

		MIN	MAX	UNIT
$V_{S-}$ to $V_{S+}$	Supply voltage		5.5	V
$V_I$	Input voltage	$V_{S-} - 0.7$	$V_{S+} + 0.7$	V
$V_{ID}$	Differential input voltage		1	V
$I_I$	Continuous input current		0.85	mA
$I_O$	Continuous output current		60	mA
	Continuous power dissipation	See <a href="#"># 7.4</a> and <a href="#"># 7.5</a>		
$T_J$	Maximum junction temperature		150	°C
$T_A$	Operating free-air temperature	- 40	125	°C
$T_{stg}$	Storage temperature	- 65	150	°C

- (1) Stresses beyond those listed under *Absolute Maximum Ratings* may cause permanent damage to the device. These are stress ratings only, which do not imply functional operation of the device at these or any other conditions beyond those indicated under *Recommended Operating Conditions*. Exposure to absolute-maximum-rated conditions for extended periods may affect device reliability.

### 7.2 ESD Ratings

		VALUE	UNIT
$V_{(ESD)}$	Electrostatic discharge	Human body model (HBM), per ANSI/ESDA/JEDEC JS-001 <sup>(1)</sup>	±6000
		Charged-device model (CDM), per JEDEC specification JESD22-C101 <sup>(2)</sup>	±1000
		Machine model	±200

- (1) JEDEC document JEP155 states that 500-V HBM allows safe manufacturing with a standard ESD control process.  
 (2) JEDEC document JEP157 states that 250-V CDM allows safe manufacturing with a standard ESD control process.

### 7.3 Recommended Operating Conditions

over operating free-air temperature range (unless otherwise noted)

		MIN	NOM	MAX	UNIT
$V_{S+}$	Single supply voltage	2.5	5	5.5	V
$T_A$	Ambient temperature	- 40	25	125	°C

### 7.4 Thermal Information: OPA835

THERMAL METRIC <sup>(1)</sup>	OPA835		UNIT	
	DBV (SOT23-6)	RUN (QFN)		
	6 PINS	10 PINS		
$R_{\theta JA}$	Junction-to-ambient thermal resistance	194	145.8	°C/W
$R_{\theta JCTop}$	Junction-to-case (top) thermal resistance	129.2	75.1	°C/W
$R_{\theta JB}$	Junction-to-board thermal resistance	39.4	38.9	°C/W
$\psi_{JT}$	Junction-to-top characterization parameter	25.6	13.5	°C/W
$\psi_{JB}$	Junction-to-board characterization parameter	38.9	104.5	°C/W

- (1) For more information about traditional and new thermal metrics, see [Semiconductor and IC Package Thermal Metrics](#) (SPRA953).

## 7.5 Thermal Information: OPA2835

THERMAL METRIC <sup>(1)</sup>		OPA2835				UNIT
		D (SOIC)	DGS (VSSOP)	RUN (QFN)	RMC (UQFN)	
		8 PINS	10 PINS	10 PINS	10 PINS	
R <sub>θJA</sub>	Junction-to-ambient thermal resistance	150.1	206	145.8	143.2	°C/W
R <sub>θJCTop</sub>	Junction-to-case (top) thermal resistance	83.8	75.3	75.1	49.0	°C/W
R <sub>θJB</sub>	Junction-to-board thermal resistance	68.4	96.2	38.9	61.9	°C/W
ψ <sub>JT</sub>	Junction-to-top characterization parameter	33.0	12.9	13.5	3.3	°C/W
ψ <sub>JB</sub>	Junction-to-board characterization parameter	67.9	94.6	104.5	61.9	°C/W

(1) For more information about traditional and new thermal metrics, see [Semiconductor and IC Package Thermal Metrics](#) (SPRA953).

## 7.6 Electrical Characteristics: V<sub>S</sub> = 2.7 V

at V<sub>S+</sub> = +2.7 V, V<sub>S-</sub> = 0 V, V<sub>OUT</sub> = 1 V<sub>PP</sub>, R<sub>F</sub> = 0 Ω, R<sub>L</sub> = 2 kΩ, G = 1 V/V, input and output referenced to mid-supply, V<sub>IN\_CM</sub> = mid-supply - 0.5 V. T<sub>A</sub> = 25°C, unless otherwise noted.

PARAMETER	TEST CONDITIONS	MIN	TYP	MAX	UNIT	TEST LEVEL <sup>(1)</sup>
<b>AC PERFORMANCE</b>						
Small-signal bandwidth	V <sub>OUT</sub> = 100 mV <sub>PP</sub> , G = 1		51		MHz	C
	V <sub>OUT</sub> = 100 mV <sub>PP</sub> , G = 2		22.5			
	V <sub>OUT</sub> = 100 mV <sub>PP</sub> , G = 5		7.2			
	V <sub>OUT</sub> = 100 mV <sub>PP</sub> , G = 10		3			
Gain-bandwidth product	V <sub>OUT</sub> = 100 mV <sub>PP</sub> , G = 10		30		MHz	C
Large-signal bandwidth	V <sub>OUT</sub> = 1 V <sub>PP</sub> , G = 1		24		MHz	C
Bandwidth for 0.1-dB flatness	V <sub>OUT</sub> = 1 V <sub>PP</sub> , G = 2		4		MHz	C
Slew rate, rise	V <sub>OUT</sub> = 1 V <sub>STEP</sub> , G = 2		110		V/μs	C
Slew rate, fall	V <sub>OUT</sub> = 1 V <sub>STEP</sub> , G = 2		130		V/μs	C
Rise time	V <sub>OUT</sub> = 1 V <sub>STEP</sub> , G = 2		9.5		ns	C
Fall time	V <sub>OUT</sub> = 1 V <sub>STEP</sub> , G = 2		9		ns	C
Settling time to 1%, rise	V <sub>OUT</sub> = 1 V <sub>STEP</sub> , G = 2		35		ns	C
Settling time to 1%, fall	V <sub>OUT</sub> = 1 V <sub>STEP</sub> , G = 2		30		ns	C
Settling time to 0.1%, rise	V <sub>OUT</sub> = 1 V <sub>STEP</sub> , G = 2		60		ns	C
Settling time to 0.1%, fall	V <sub>OUT</sub> = 1 V <sub>STEP</sub> , G = 2		65		ns	C
Settling time to 0.01%, rise	V <sub>OUT</sub> = 1 V <sub>STEP</sub> , G = 2		120		ns	C
Settling time to 0.01%, fall	V <sub>OUT</sub> = 1 V <sub>STEP</sub> , G = 2		90		ns	C
Overshoot/Undershoot	V <sub>OUT</sub> = 1 V <sub>STEP</sub> , G = 2		0.5%/0.2%			C
Second-order harmonic distortion	f = 10 kHz, V <sub>IN_CM</sub> = mid-supply - 0.5 V		-133		dBc	C
	f = 100 kHz, V <sub>IN_CM</sub> = mid-supply - 0.5 V		-110			
	f = 1 MHz, V <sub>IN_CM</sub> = mid-supply - 0.5 V		-73			
Third-order harmonic distortion	f = 10 kHz, V <sub>IN_CM</sub> = mid-supply - 0.5 V		-137		dBc	C
	f = 100 kHz, V <sub>IN_CM</sub> = mid-supply - 0.5 V		-125			
	f = 1 MHz, V <sub>IN_CM</sub> = mid-supply - 0.5 V		-78			
Second-order intermodulation distortion	f = 1 MHz, 200-kHz Tone Spacing, V <sub>OUT</sub> Envelope = 1 V <sub>PP</sub> , V <sub>IN_CM</sub> = mid-supply - 0.5 V		-75		dBc	C
Third-order intermodulation distortion	f = 1 MHz, 200-kHz Tone Spacing, V <sub>OUT</sub> Envelope = 1 V <sub>PP</sub> , V <sub>IN_CM</sub> = mid-supply - 0.5 V		-81		dBc	C
Input voltage noise	f = 100 kHz		9.3		nV/√Hz	C
Voltage noise 1/f corner frequency			147		Hz	C

## 7.6 Electrical Characteristics: $V_S = 2.7\text{ V}$ (continued)

at  $V_{S+} = +2.7\text{ V}$ ,  $V_{S-} = 0\text{ V}$ ,  $V_{OUT} = 1\text{ V}_{PP}$ ,  $R_F = 0\ \Omega$ ,  $R_L = 2\text{ k}\Omega$ ,  $G = 1\text{ V/V}$ , input and output referenced to mid-supply,  $V_{IN\_CM} = \text{mid-supply} - 0.5\text{ V}$ .  $T_A = 25^\circ\text{C}$ , unless otherwise noted.

PARAMETER	TEST CONDITIONS	MIN	TYP	MAX	UNIT	TEST LEVEL <sup>(1)</sup>
<b>AC PERFORMANCE (continued)</b>						
Input current noise	$f = 1\text{ MHz}$		0.45		$\text{pA}/\sqrt{\text{Hz}}$	C
Current noise 1/f corner frequency			14.7		kHz	C
Overdrive recovery time, over/under	Overdrive = 0.5 V		140/125		ns	C
Closed-loop output impedance	$f = 100\text{ kHz}$		0.028		$\Omega$	C
Channel-to-channel crosstalk (OPA2835)	$f = 10\text{ kHz}$		-120		dB	C
<b>DC PERFORMANCE</b>						
Open-loop voltage gain ( $A_{OL}$ )		100	120		dB	A
Input referred offset voltage	$T_A = 25^\circ\text{C}$	-500	$\pm 100$	500	$\mu\text{V}$	A
	$T_A = 0^\circ\text{C to } 70^\circ\text{C}$	-880		880		B
	$T_A = -40^\circ\text{C to } 85^\circ\text{C}$	-1040		1040		
	$T_A = -40^\circ\text{C to } 125^\circ\text{C}$	-1850		1850		
Input offset voltage drift <sup>(3)</sup>	$T_A = 0^\circ\text{C to } 70^\circ\text{C}$	-8.5	$\pm 1.4$	8.5	$\mu\text{V}/^\circ\text{C}$	B
	$T_A = -40^\circ\text{C to } 85^\circ\text{C}$	-9	$\pm 1.5$	9		
	$T_A = -40^\circ\text{C to } 125^\circ\text{C}$	-13.5	$\pm 2.25$	13.5		
Input bias current <sup>(2)</sup>	$T_A = 25^\circ\text{C}$	50	200	400	nA	A
	$T_A = 0^\circ\text{C to } 70^\circ\text{C}$	47		410		B
	$T_A = -40^\circ\text{C to } 85^\circ\text{C}$	45		425		
	$T_A = -40^\circ\text{C to } 125^\circ\text{C}$	45		530		
Input bias current drift <sup>(3)</sup>	$T_A = 0^\circ\text{C to } 70^\circ\text{C}$	-1.4	$\pm 0.25$	1.4	nA/ $^\circ\text{C}$	B
	$T_A = -40^\circ\text{C to } 85^\circ\text{C}$	-1.05	$\pm 0.175$	1.05		
	$T_A = -40^\circ\text{C to } 125^\circ\text{C}$	-1.1	$\pm 0.185$	1.1		
Input offset current	$T_A = 25^\circ\text{C}$	-100	$\pm 13$	100	nA	A
	$T_A = 0^\circ\text{C to } 70^\circ\text{C}$	-100	$\pm 13$	100		B
	$T_A = -40^\circ\text{C to } 85^\circ\text{C}$	-100	$\pm 13$	100		
	$T_A = -40^\circ\text{C to } 125^\circ\text{C}$	-100	$\pm 13$	100		
Input offset current drift <sup>(3)</sup>	$T_A = 0^\circ\text{C to } 70^\circ\text{C}$	-1.230	$\pm 0.205$	1.230	nA/ $^\circ\text{C}$	B
	$T_A = -40^\circ\text{C to } 85^\circ\text{C}$	-0.940	$\pm 0.155$	0.940		
	$T_A = -40^\circ\text{C to } 125^\circ\text{C}$	-0.940	$\pm 0.155$	0.940		
<b>INPUT</b>						
Common-mode input range low	$T_A = 25^\circ\text{C}$ , < 3-dB degradation in CMRR limit		-0.2	0	V	A
	$T_A = -40^\circ\text{C to } 125^\circ\text{C}$ , < 3-dB degradation in CMRR limit		-0.2	0	V	B
Common-mode input range high	$T_A = 25^\circ\text{C}$ , < 3-dB degradation in CMRR limit	1.5	1.6		V	A
	$T_A = -40^\circ\text{C to } 125^\circ\text{C}$ , < 3-dB degradation in CMRR limit	1.5	1.6		V	B
Common-mode rejection ratio		88	110		dB	A
Input impedance common-mode			250    1.2		$\text{M}\Omega$    pF	C
Input impedance differential mode			200    1		$\text{k}\Omega$    pF	C
<b>OUTPUT</b>						
Output voltage low	$T_A = 25^\circ\text{C}$ , $G = 5$		0.15	0.2	V	A
	$T_A = -40^\circ\text{C to } 125^\circ\text{C}$ , $G = 5$		0.15	0.2	V	B
Output voltage high	$T_A = 25^\circ\text{C}$ , $G = 5$	2.45	2.5		V	A
	$T_A = -40^\circ\text{C to } 125^\circ\text{C}$ , $G = 5$	2.45	2.5		V	B
Output saturation voltage, high/low	$T_A = 25^\circ\text{C}$ , $G = 5$		45/13		mV	C
Output current drive	$T_A = 25^\circ\text{C}$	$\pm 25$	$\pm 35$		mA	A
	$T_A = -40^\circ\text{C to } 125^\circ\text{C}$	$\pm 20$			mA	B

## 7.6 Electrical Characteristics: $V_S = 2.7\text{ V}$ (continued)

at  $V_{S+} = +2.7\text{ V}$ ,  $V_{S-} = 0\text{ V}$ ,  $V_{OUT} = 1\text{ V}_{PP}$ ,  $R_F = 0\ \Omega$ ,  $R_L = 2\text{ k}\Omega$ ,  $G = 1\text{ V/V}$ , input and output referenced to mid-supply,  $V_{IN\_CM} = \text{mid-supply} - 0.5\text{ V}$ .  $T_A = 25^\circ\text{C}$ , unless otherwise noted.

PARAMETER	TEST CONDITIONS	MIN	TYP	MAX	UNIT	TEST LEVEL <sup>(1)</sup>
<b>GAIN-SETTING RESISTORS (OPA835IRUN ONLY)</b>						
Resistor FB1 to FB2	DC resistance	2376	2400	2424	$\Omega$	A
Resistor FB2 to FB3	DC resistance	1782	1800	1818	$\Omega$	A
Resistor FB3 to FB4	DC resistance	594	600	606	$\Omega$	A
Resistor tolerance	DC resistance	- 1%		1%		A
Resistor temperature coefficient	DC resistance		< 10		PPM	C
<b>POWER SUPPLY</b>						
Specified operating voltage		2.5		5.5	V	B
Quiescent operating current per amplifier	$T_A = 25^\circ\text{C}$	175	245	340	$\mu\text{A}$	A
	$T_A = -40^\circ\text{C}$ to $125^\circ\text{C}$	135		345	$\mu\text{A}$	B
Power supply rejection ( $\pm\text{PSRR}$ )		88	105		dB	A
<b>POWER DOWN (PIN MUST BE DRIVEN)</b>						
Enable voltage threshold	Specified on above $V_{S-} + 2.1\text{ V}$		1.4	2.1	V	A
Disable voltage threshold	Specified off below $V_{S-} + 0.7\text{ V}$	0.7	1.4		V	A
Power-down pin bias current	$\overline{\text{PD}} = 0.5\text{ V}$		20	500	nA	A
Power-down quiescent current	$\overline{\text{PD}} = 0.5\text{ V}$		0.5	1.5	$\mu\text{A}$	A
Turnon time delay	Time from $\overline{\text{PD}} = \text{high}$ to $V_{OUT} = 90\%$ of final value		250		ns	C
Turnoff time delay	Time from $\overline{\text{PD}} = \text{low}$ to $V_{OUT} = 10\%$ of original value		50		ns	C

- (1) Test levels (all values set by characterization and simulation): **(A)** 100% tested at  $25^\circ\text{C}$ ; over temperature limits by characterization and simulation. **(B)** Not tested in production; limits set by characterization and simulation. **(C)** Typical value only for information.
- (2) Current is considered positive out of the pin.
- (3) Input Offset Voltage Drift, Input Bias Current Drift, and Input Offset Current Drift are average values calculated by taking data at the end points, computing the difference, and dividing by the temperature range.

## 7.7 Electrical Characteristics: $V_S = 5\text{ V}$

at  $V_{S+} = +5\text{ V}$ ,  $V_{S-} = 0\text{ V}$ ,  $V_{OUT} = 2\text{ V}_{PP}$ ,  $R_F = 0\ \Omega$ ,  $R_L = 2\text{ k}\Omega$ ,  $G = 1\text{ V/V}$ , input and output referenced to mid-supply.  $T_A = 25^\circ\text{C}$ , unless otherwise noted.

PARAMETER	CONDITIONS	MIN	TYP	MAX	UNIT	TEST LEVEL <sup>(1)</sup>
<b>AC PERFORMANCE</b>						
Small-signal bandwidth	$V_{OUT} = 100\text{ mV}_{PP}$ , $G = 1$		56		MHz	C
	$V_{OUT} = 100\text{ mV}_{PP}$ , $G = 2$		22.5			
	$V_{OUT} = 100\text{ mV}_{PP}$ , $G = 5$		7.4			
	$V_{OUT} = 100\text{ mV}_{PP}$ , $G = 10$		3.1			
Gain-bandwidth product	$V_{OUT} = 100\text{ mV}_{PP}$ , $G = 10$		31		MHz	C
Large-signal bandwidth	$V_{OUT} = 2\text{ V}_{PP}$ , $G = 1$		31		MHz	C
Bandwidth for 0.1-dB flatness	$V_{OUT} = 2\text{ V}_{PP}$ , $G = 2$		14.5		MHz	C
Slew rate, rise	$V_{OUT} = 2\text{-V Step}$ , $G = 2$		160		V/ $\mu\text{s}$	C
Slew rate, fall	$V_{OUT} = 2\text{-V Step}$ , $G = 2$		260		V/ $\mu\text{s}$	C
Rise time	$V_{OUT} = 2\text{-V Step}$ , $G = 2$		10		ns	C
Fall time	$V_{OUT} = 2\text{-V Step}$ , $G = 2$		7		ns	C
Settling time to 1%, rise	$V_{OUT} = 2\text{-V Step}$ , $G = 2$		45		ns	C
Settling time to 1%, fall	$V_{OUT} = 2\text{-V Step}$ , $G = 2$		45		ns	C
Settling time to 0.1%, rise	$V_{OUT} = 2\text{-V Step}$ , $G = 2$		50		ns	C
Settling time to 0.1%, fall	$V_{OUT} = 2\text{-V Step}$ , $G = 2$		55		ns	C
Settling time to 0.01%, rise	$V_{OUT} = 2\text{-V Step}$ , $G = 2$		82		ns	C
Settling time to 0.01%, fall	$V_{OUT} = 2\text{-V Step}$ , $G = 2$		85		ns	C
Overshoot/Undershoot	$V_{OUT} = 2\text{-V Step}$ , $G = 2$		2.5%/1.5%			C
Second-order harmonic distortion	$f = 10\text{ kHz}$		-135		dBc	C
	$f = 100\text{ kHz}$		-105			
	$f = 1\text{ MHz}$		-70			
<b>AC PERFORMANCE (continued)</b>						
Third-order harmonic distortion	$f = 10\text{ kHz}$		-139		dBc	C
	$f = 100\text{ kHz}$		-122			
	$f = 1\text{ MHz}$		-73			
Second-order intermodulation distortion	$f = 1\text{ MHz}$ , 200-kHz Tone Spacing, $V_{OUT}$ Envelope = $2\text{ V}_{PP}$		-70		dBc	C
Third-order intermodulation distortion	$f = 1\text{ MHz}$ , 200-kHz Tone Spacing, $V_{OUT}$ Envelope = $2\text{ V}_{PP}$		-83		dBc	C
Signal-to-noise ratio, SNR	$f = 1\text{ kHz}$ , $V_{OUT} = 1\text{ V}_{RMS}$ , 22-kHz bandwidth		0.00015%		dBc	C
			-116.4			
Total harmonic distortion, THD	$f = 1\text{ kHz}$ , $V_{OUT} = 1\text{ V}_{RMS}$		0.00003%		dBc	C
			-130			
Input voltage noise	$f = 100\text{ kHz}$		9.3		nV/ $\sqrt{\text{Hz}}$	C
Voltage noise 1/f corner frequency			147		Hz	C
Input current noise	$f = 1\text{ MHz}$		0.45		pA/ $\sqrt{\text{Hz}}$	C
Current noise 1/f corner frequency			14.7		kHz	C
Overdrive recovery time, over/under	Overdrive = $0.5\text{ V}$		195/135		ns	C
Closed-loop output impedance	$f = 100\text{ kHz}$		0.028		$\Omega$	C
Channel to channel crosstalk (OPA2835)	$f = 10\text{ kHz}$		-120		dB	C
<b>DC PERFORMANCE</b>						
Open-loop voltage gain ( $A_{OL}$ )		100	120		dB	A

## 7.7 Electrical Characteristics: $V_S = 5\text{ V}$ (continued)

at  $V_{S+} = +5\text{ V}$ ,  $V_{S-} = 0\text{ V}$ ,  $V_{OUT} = 2\text{ V}_{PP}$ ,  $R_F = 0\ \Omega$ ,  $R_L = 2\text{ k}\Omega$ ,  $G = 1\text{ V/V}$ , input and output referenced to mid-supply.  $T_A = 25^\circ\text{C}$ , unless otherwise noted.

PARAMETER	CONDITIONS	MIN	TYP	MAX	UNIT	TEST LEVEL <sup>(1)</sup>
Input referred offset voltage	$T_A = 25^\circ\text{C}$	-500	$\pm 100$	500	$\mu\text{V}$	A
	$T_A = 0^\circ\text{C}$ to $70^\circ\text{C}$	-880		880		B
	$T_A = -40^\circ\text{C}$ to $85^\circ\text{C}$	-1040		1040		
	$T_A = -40^\circ\text{C}$ to $125^\circ\text{C}$	-1850		1850		
Input offset voltage drift <sup>(3)</sup>	$T_A = 0^\circ\text{C}$ to $70^\circ\text{C}$	-8.5	$\pm 1.4$	8.5	$\mu\text{V}/^\circ\text{C}$	B
	$T_A = -40^\circ\text{C}$ to $85^\circ\text{C}$	-9	$\pm 1.5$	9		
	$T_A = -40^\circ\text{C}$ to $125^\circ\text{C}$	-13.5	$\pm 2.25$	13.5		
Input bias current <sup>(2)</sup>	$T_A = 25^\circ\text{C}$	50	200	400	nA	A
	$T_A = 0^\circ\text{C}$ to $70^\circ\text{C}$	47		410		B
	$T_A = -40^\circ\text{C}$ to $85^\circ\text{C}$	45		425		
	$T_A = -40^\circ\text{C}$ to $125^\circ\text{C}$	45		530		
Input bias current drift <sup>(3)</sup>	$T_A = 0^\circ\text{C}$ to $70^\circ\text{C}$	-1.4	$\pm 0.25$	1.4	nA/ $^\circ\text{C}$	B
	$T_A = -40^\circ\text{C}$ to $85^\circ\text{C}$	-1.05	$\pm 0.175$	1.05		
	$T_A = -40^\circ\text{C}$ to $125^\circ\text{C}$	-1.1	$\pm 0.185$	1.1		
Input offset current	$T_A = 25^\circ\text{C}$	-100	$\pm 13$	100	nA	A
	$T_A = 0^\circ\text{C}$ to $70^\circ\text{C}$	-100	$\pm 13$	100		B
	$T_A = -40^\circ\text{C}$ to $85^\circ\text{C}$	-100	$\pm 13$	100		
	$T_A = -40^\circ\text{C}$ to $125^\circ\text{C}$	-100	$\pm 13$	100		
Input offset current drift <sup>(3)</sup>	$T_A = 0^\circ\text{C}$ to $70^\circ\text{C}$	-1.23	$\pm 0.205$	1.23	nA/ $^\circ\text{C}$	B
	$T_A = -40^\circ\text{C}$ to $85^\circ\text{C}$	-0.94	$\pm 0.155$	0.94		
	$T_A = -40^\circ\text{C}$ to $125^\circ\text{C}$	-0.94	$\pm 0.155$	0.94		
<b>INPUT</b>						
Common-mode input range low	$T_A = 25^\circ\text{C}$ , < 3-dB degradation in CMRR limit		-0.2	0	V	A
	$T_A = -40^\circ\text{C}$ to $125^\circ\text{C}$ , < 3-dB degradation in CMRR limit		-0.2	0	V	B
Common-mode input range high	$T_A = 25^\circ\text{C}$ , < 3-dB degradation in CMRR limit	3.8	3.9		V	A
	$T_A = -40^\circ\text{C}$ to $125^\circ\text{C}$ , < 3-dB degradation in CMRR limit	3.8	3.9		V	B
Common-mode rejection ratio		91	113		dB	A
Input impedance common-mode			250    1.2		M $\Omega$    pF	C
Input impedance differential mode			200    1		k $\Omega$    pF	C
<b>OUTPUT</b>						
Output voltage low	$T_A = 25^\circ\text{C}$ , $G = 5$		0.15	0.2	V	A
	$T_A = -40^\circ\text{C}$ to $125^\circ\text{C}$ , $G = 5$		0.15	0.2	V	B
Output voltage high	$T_A = 25^\circ\text{C}$ , $G = 5$	4.75	4.8		V	A
	$T_A = -40^\circ\text{C}$ to $125^\circ\text{C}$ , $G = 5$	4.75	4.8		V	B
Output saturation voltage, high/low	$T_A = 25^\circ\text{C}$ , $G = 5$		70/25		mV	C
Output current drive	$T_A = 25^\circ\text{C}$	$\pm 30$	$\pm 40$		mA	A
	$T_A = -40^\circ\text{C}$ to $125^\circ\text{C}$	$\pm 25$			mA	B
<b>GAIN-SETTING RESISTORS (OPA835IRUN ONLY)</b>						
Resistor FB1 to FB2	DC resistance	2376	2400	2424	$\Omega$	A
Resistor FB2 to FB3	DC resistance	1782	1800	1818	$\Omega$	A
Resistor FB3 to FB4	DC resistance	594	600	606	$\Omega$	A
Resistor tolerance	DC resistance	-1%		1%		A
Resistor temperature coefficient	DC resistance		<10		PPM	C
<b>POWER SUPPLY</b>						

## 7.7 Electrical Characteristics: $V_S = 5\text{ V}$ (continued)

at  $V_{S+} = +5\text{ V}$ ,  $V_{S-} = 0\text{ V}$ ,  $V_{OUT} = 2\text{ V}_{PP}$ ,  $R_F = 0\ \Omega$ ,  $R_L = 2\text{ k}\Omega$ ,  $G = 1\text{ V/V}$ , input and output referenced to mid-supply.  $T_A = 25^\circ\text{C}$ , unless otherwise noted.

PARAMETER	CONDITIONS	MIN	TYP	MAX	UNIT	TEST LEVEL <sup>(1)</sup>
Specified operating voltage		2.5		5.5	V	B
Quiescent operating current per amplifier	$T_A = 25^\circ\text{C}$	200	250	350	$\mu\text{A}$	A
	$T_A = -40^\circ\text{C}$ to $125^\circ\text{C}$	150		365	$\mu\text{A}$	B
Power supply rejection ( $\pm\text{PSRR}$ )		90	110		dB	A
<b>POWER DOWN (PIN MUST BE DRIVEN)</b>						
Enable voltage threshold	Specified "on" above $V_{S-} + 2.1\text{ V}$		1.4	2.1	V	A
Disable voltage threshold	Specified "off" below $V_{S-} + 0.7\text{ V}$	0.7	1.4		V	A
Power-down pin bias current	$\overline{\text{PD}} = 0.5\text{ V}$		20	500	nA	A
Power-down quiescent current	$\overline{\text{PD}} = 0.5\text{ V}$		0.5	1.5	$\mu\text{A}$	A
Turnon time delay	Time from $\overline{\text{PD}} = \text{high}$ to $V_{OUT} = 90\%$ of final value		200		ns	C
Turnoff time delay	Time from $\overline{\text{PD}} = \text{low}$ to $V_{OUT} = 10\%$ of original value		60		ns	C

- (1) Test levels (all values set by characterization and simulation): **(A)** 100% tested at  $25^\circ\text{C}$ ; over temperature limits by characterization and simulation. **(B)** Not tested in production; limits set by characterization and simulation. **(C)** Typical value only for information.
- (2) Current is considered positive out of the pin.
- (3) Input Offset Voltage Drift, Input Bias Current Drift, and Input Offset Current Drift are average values calculated by taking data at the end points, computing the difference, and dividing by the temperature range.

### Typical Characteristics: $V_S = 2.7\text{ V}$

Test conditions unless otherwise noted:  $V_{S+} = +2.7\text{ V}$ ,  $V_{S-} = 0\text{ V}$ ,  $V_{OUT} = 1\text{ Vpp}$ ,  $R_F = 0\ \Omega$ ,  $R_L = 2\text{ k}\Omega$ ,  $G = 1\text{ V/V}$ , input and output referenced to mid-supply,  $V_{IN\_CM} = \text{mid-supply} - 0.5\text{ V}$ .  $T_A = 25^\circ\text{C}$



图 7-1. Small-Signal Frequency Response



图 7-2. Large-Signal Frequency Response

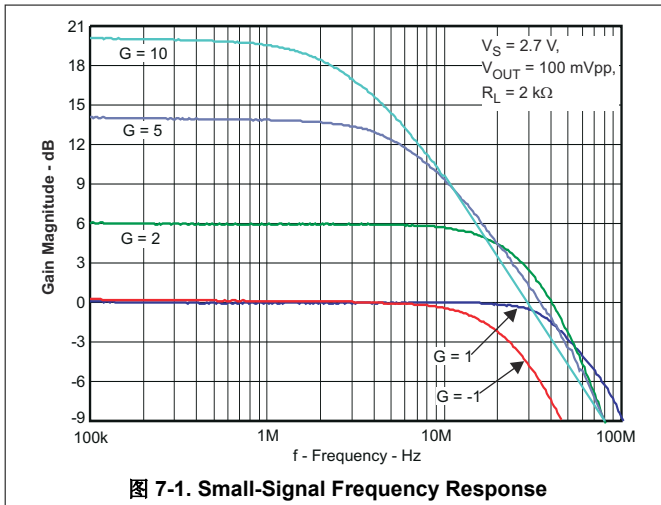

图 7-3. Noninverting Pulse Response

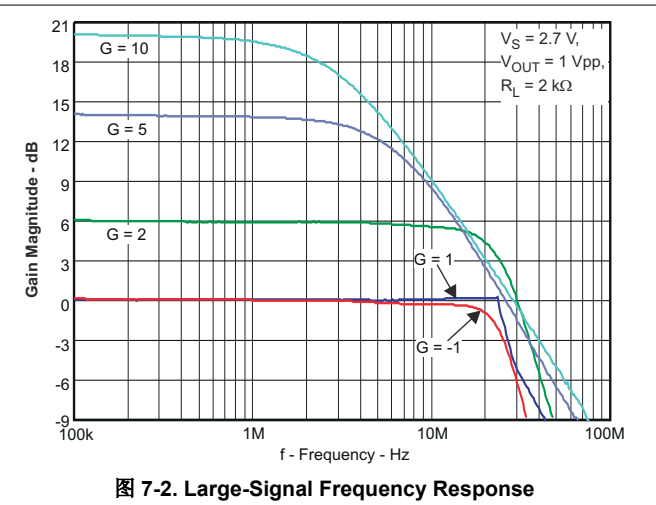

图 7-4. Inverting Pulse Response

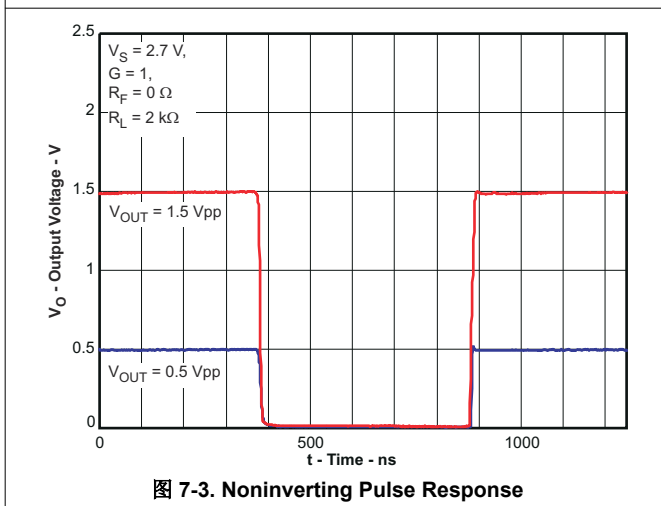

图 7-5. Slew Rate vs Output Voltage Step

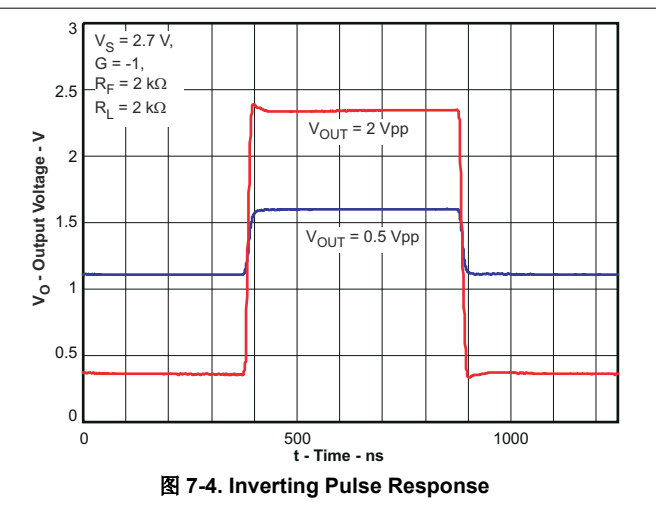

图 7-6. Output Overdrive Recovery

### Typical Characteristics: $V_S = 2.7\text{ V}$

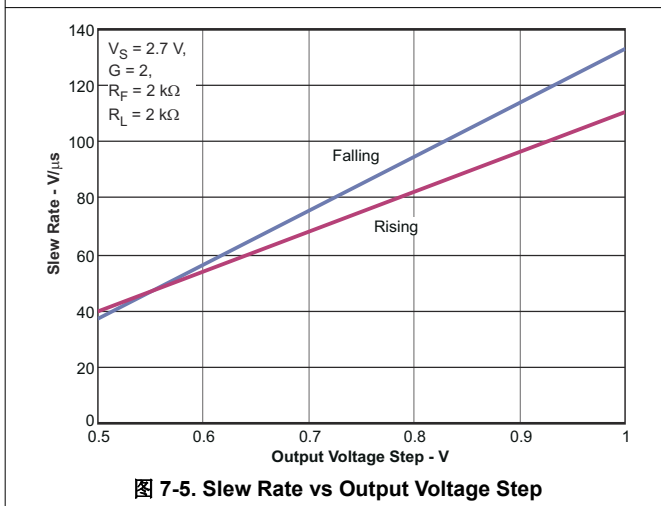
Test conditions unless otherwise noted:  $V_{S+} = +2.7\text{ V}$ ,  $V_{S-} = 0\text{ V}$ ,  $V_{OUT} = 1\text{ Vpp}$ ,  $R_F = 0\ \Omega$ ,  $R_L = 2\text{ k}\Omega$ ,  $G = 1\text{ V/V}$ , input and output referenced to mid-supply,  $V_{IN\_CM} = \text{mid-supply} - 0.5\text{ V}$ .  $T_A = 25^\circ\text{C}$

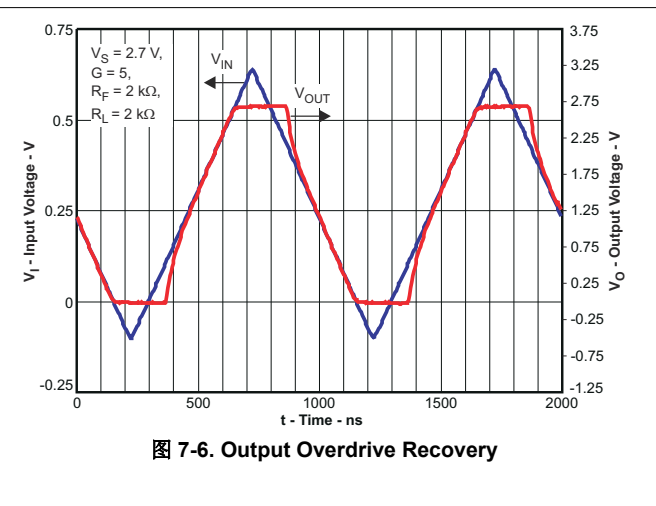

图 7-7. Harmonic Distortion vs Frequency



图 7-8. Harmonic Distortion vs Load Resistance

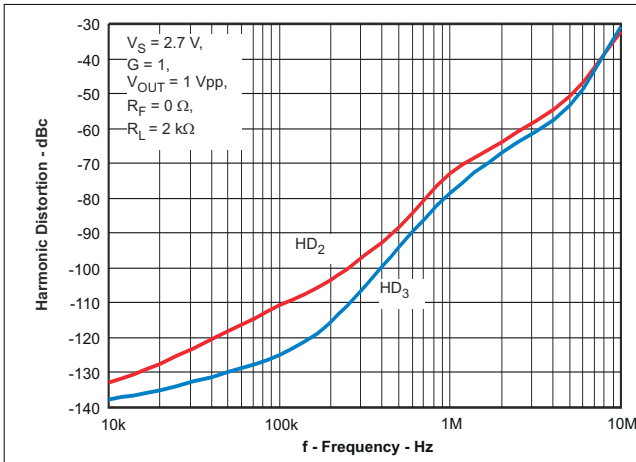

图 7-9. Harmonic Distortion vs Output Voltage

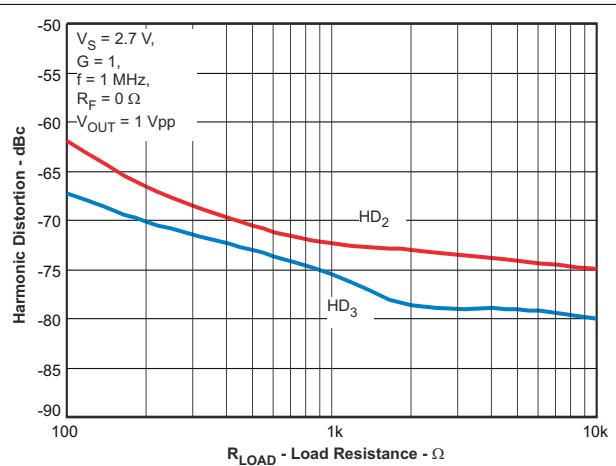

图 7-10. Harmonic Distortion vs Gain

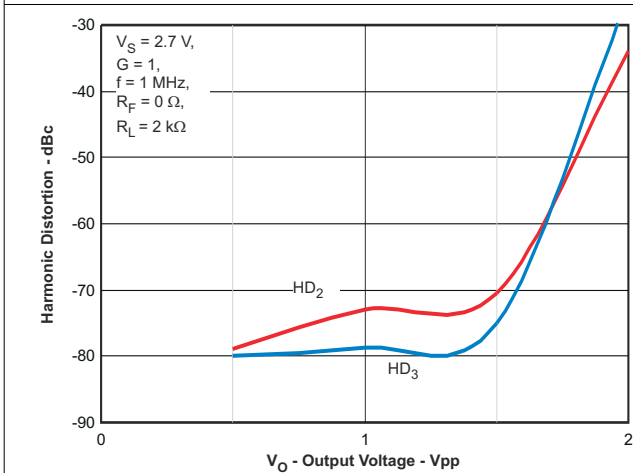

图 7-11. Output Voltage Swing vs Load Resistance

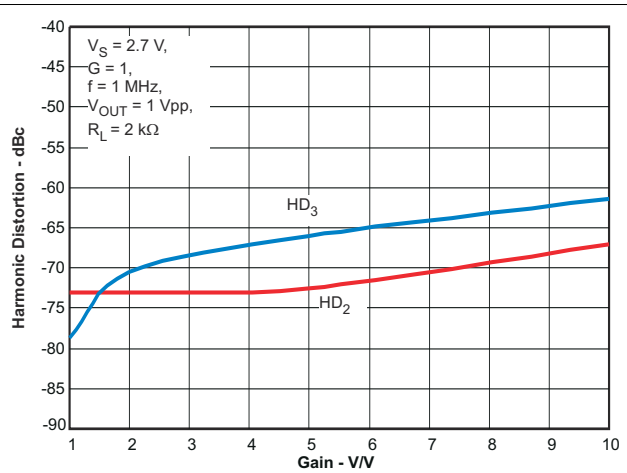

图 7-12. Output Saturation Voltage vs Load Current

### Typical Characteristics: $V_S = 2.7\text{ V}$

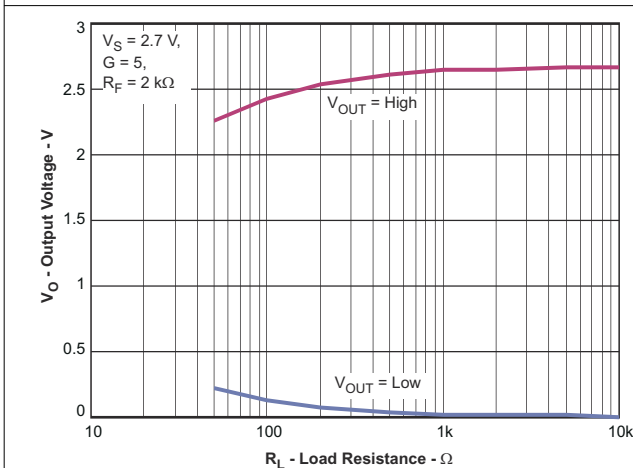
Test conditions unless otherwise noted:  $V_{S+} = +2.7\text{ V}$ ,  $V_{S-} = 0\text{ V}$ ,  $V_{OUT} = 1\text{ Vpp}$ ,  $R_F = 0\ \Omega$ ,  $R_L = 2\text{ k}\Omega$ ,  $G = 1\text{ V/V}$ , input and output referenced to mid-supply,  $V_{IN\_CM} = \text{mid-supply} - 0.5\text{ V}$ .  $T_A = 25^\circ\text{C}$

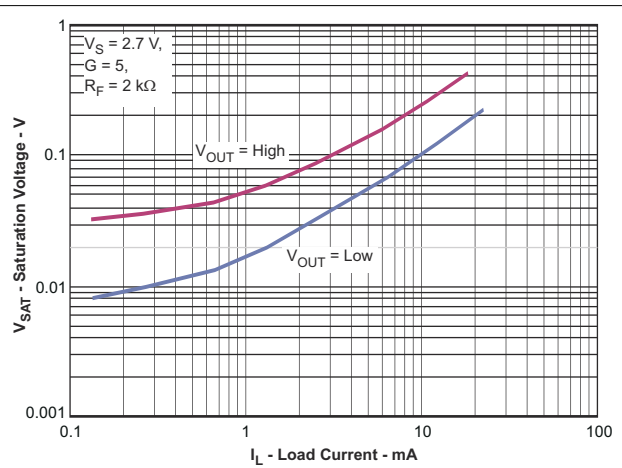

图 7-13. Output Impedance vs Frequency



图 7-14. Frequency Response With Capacitive Load

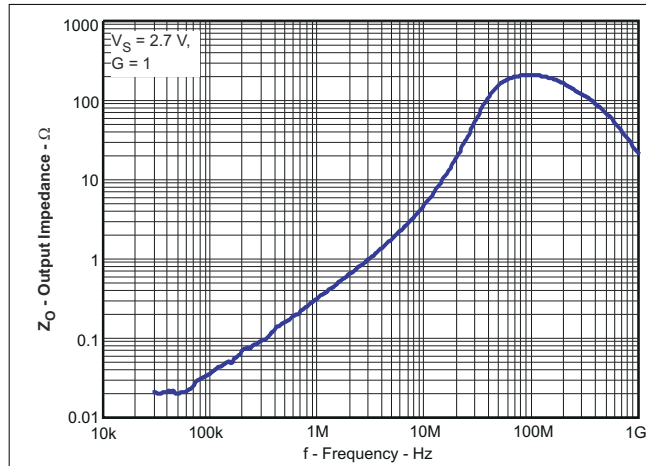

图 7-15. Series Output Resistor vs Capacitive Load

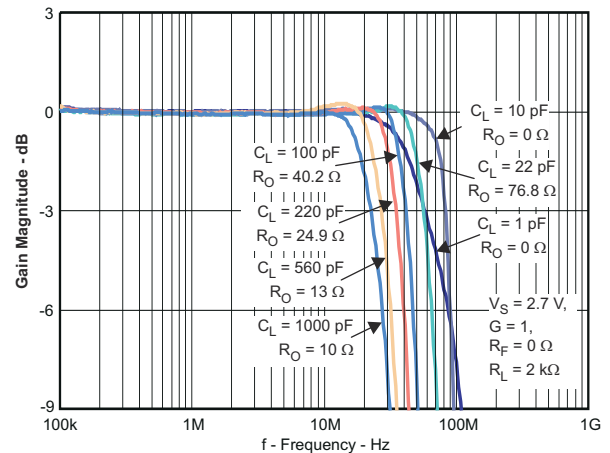

图 7-16. Input Referred Noise vs Frequency

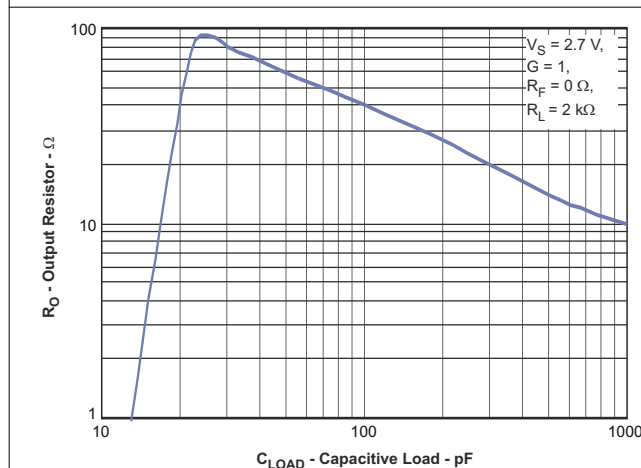

图 7-17. Open Loop Gain vs Frequency

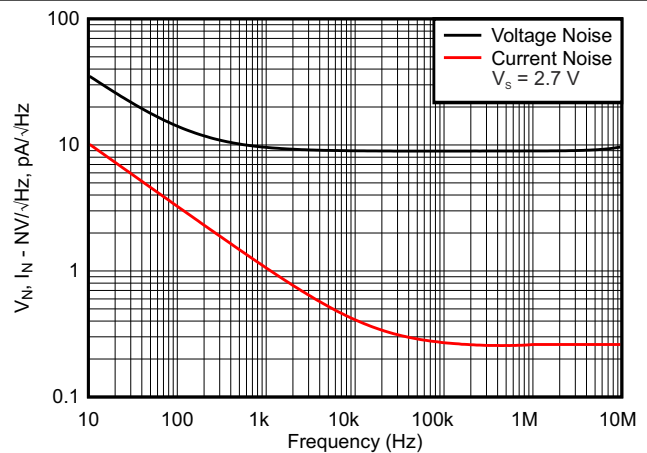

图 7-18. Common-Mode/Power Supply Rejection Ratios vs Frequency

### Typical Characteristics: $V_S = 2.7\text{ V}$

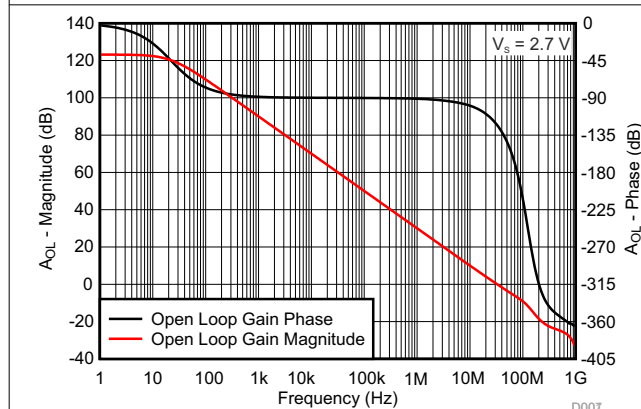
Test conditions unless otherwise noted:  $V_{S+} = +2.7\text{ V}$ ,  $V_{S-} = 0\text{ V}$ ,  $V_{OUT} = 1\text{ Vpp}$ ,  $R_F = 0\ \Omega$ ,  $R_L = 2\text{ k}\Omega$ ,  $G = 1\text{ V/V}$ , input and output referenced to mid-supply,  $V_{IN\_CM} = \text{mid-supply} - 0.5\text{ V}$ .  $T_A = 25^\circ\text{C}$

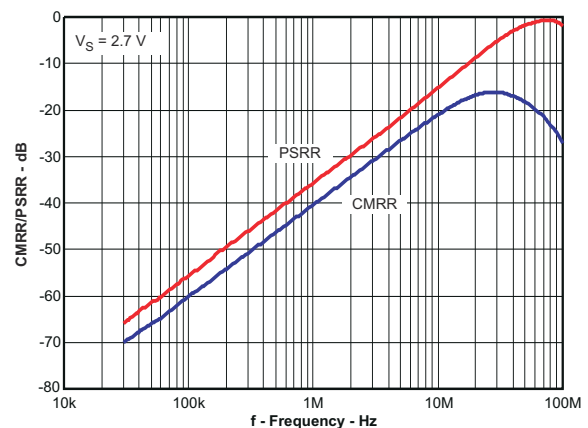

图 7-19. Crosstalk vs Frequency



图 7-20. Power Down Response

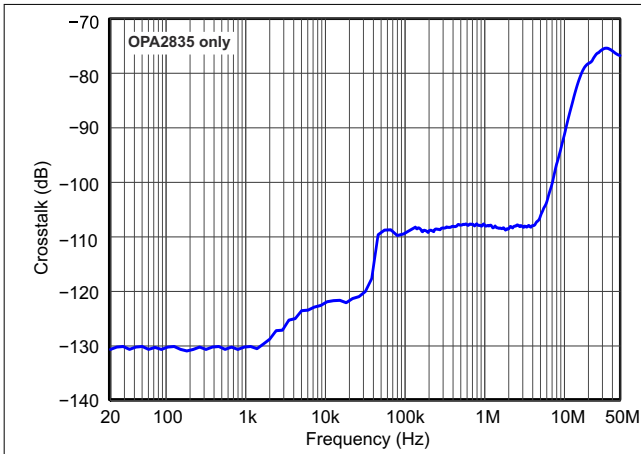

图 7-21. Input Offset Voltage

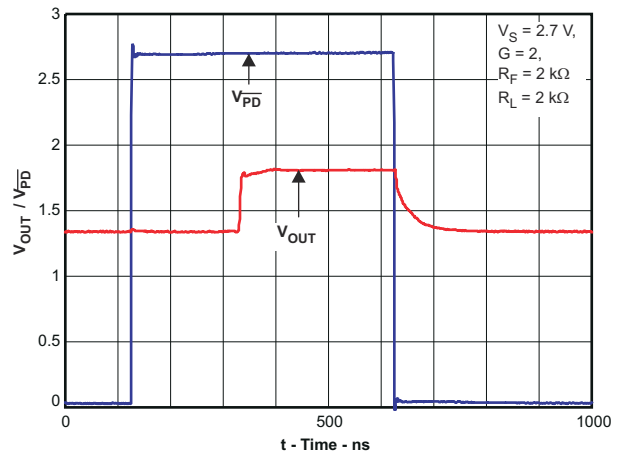

图 7-22. Input Offset Voltage vs Free-Air Temperature

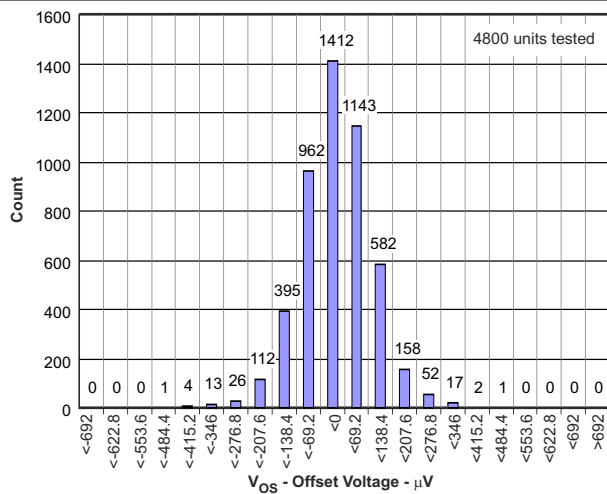

图 7-23. Input Offset Voltage Drift

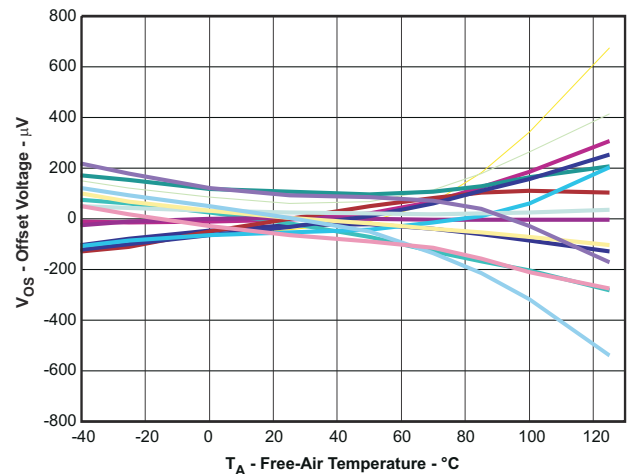

图 7-24. Input Offset Current

### Typical Characteristics: $V_S = 2.7\text{ V}$

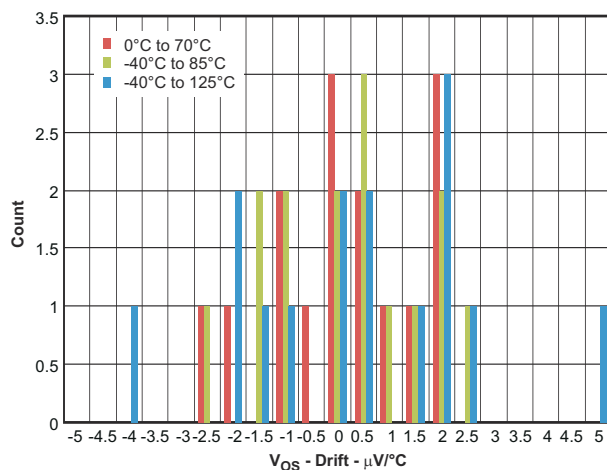
Test conditions unless otherwise noted:  $V_{S+} = +2.7\text{ V}$ ,  $V_{S-} = 0\text{ V}$ ,  $V_{OUT} = 1\text{ Vpp}$ ,  $R_F = 0\ \Omega$ ,  $R_L = 2\text{ k}\Omega$ ,  $G = 1\text{ V/V}$ , input and output referenced to mid-supply,  $V_{IN\_CM} = \text{mid-supply} - 0.5\text{ V}$ .  $T_A = 25^\circ\text{C}$

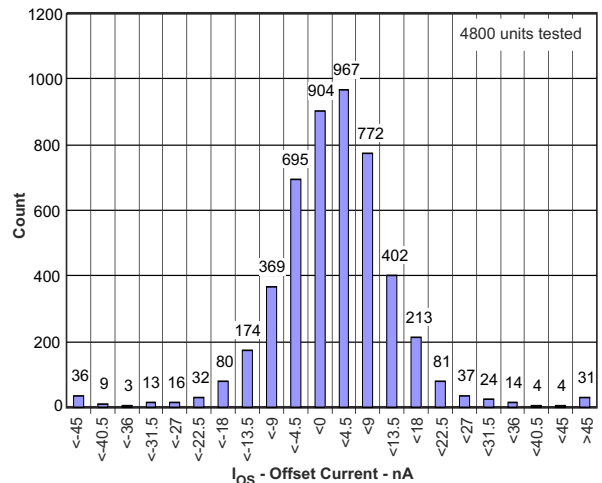
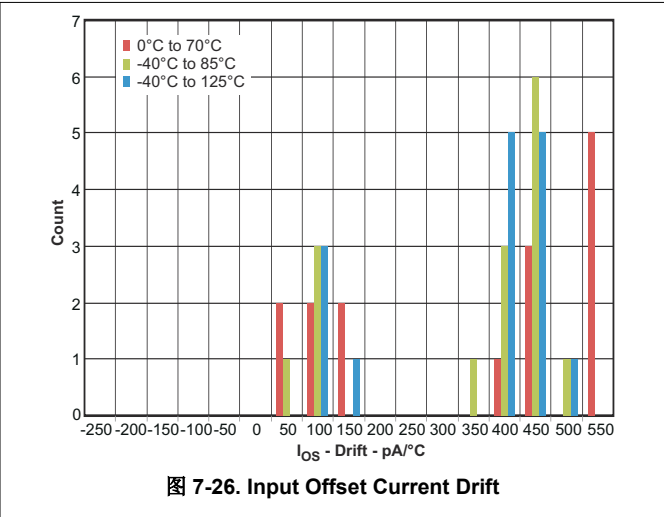
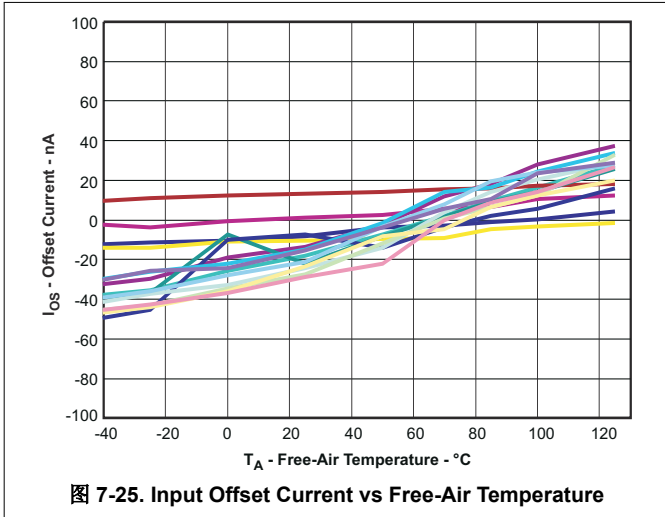

### Typical Characteristics: $V_S = 5\text{ V}$

Test conditions unless otherwise noted:  $V_{S+} = +5\text{ V}$ ,  $V_{S-} = 0\text{ V}$ ,  $V_{OUT} = 2\text{ Vpp}$ ,  $R_F = 0\ \Omega$ ,  $R_L = 2\text{ k}\Omega$ ,  $G = 1\text{ V/V}$ , input and output referenced to mid-supply.  $T_A = 25^\circ\text{C}$

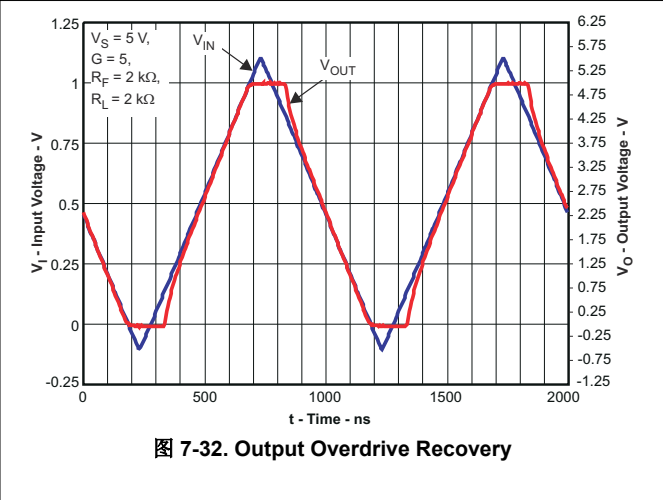
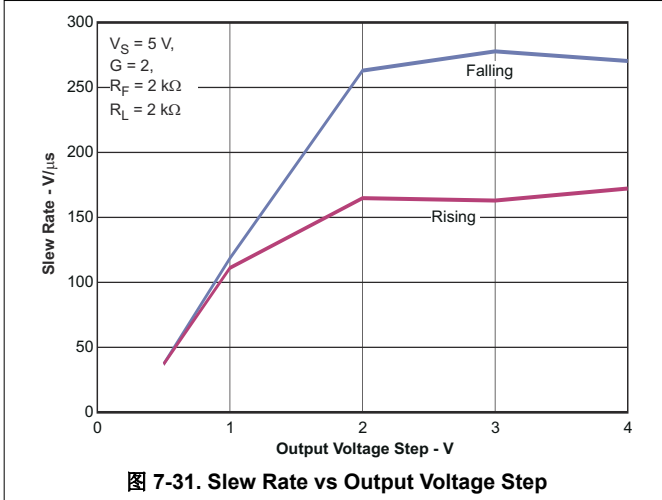
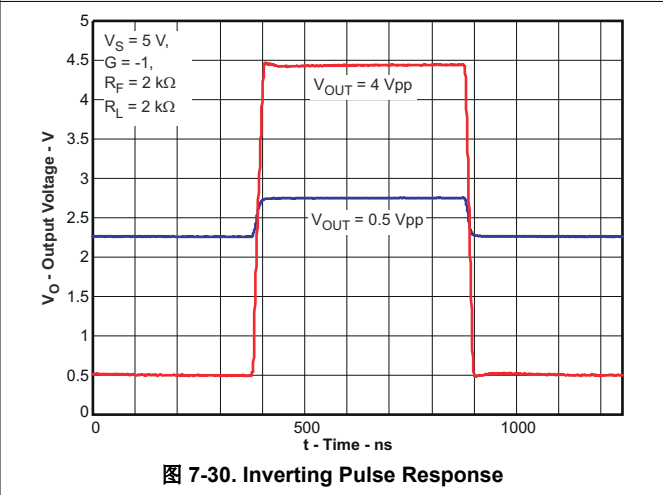
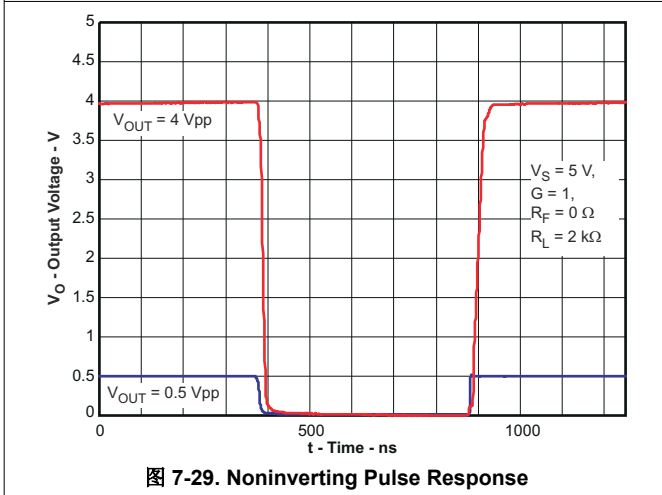
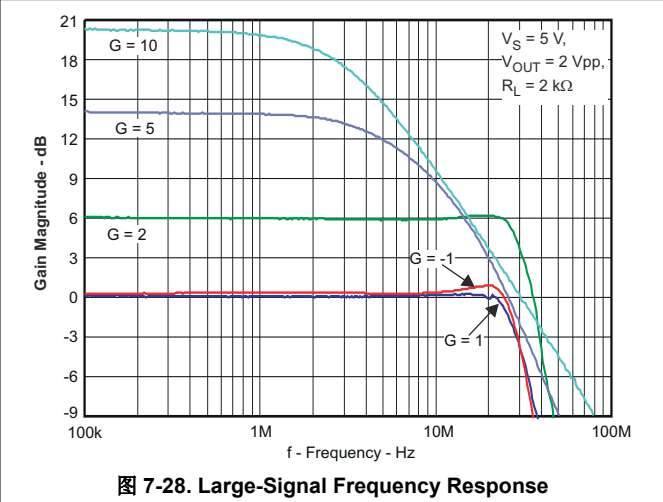
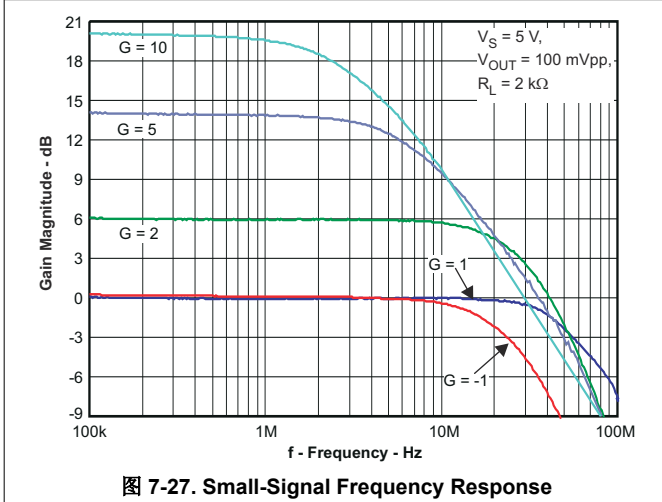

**Typical Characteristics:  $V_S = 5\text{ V}$**

Test conditions unless otherwise noted:  $V_{S+} = +5\text{ V}$ ,  $V_{S-} = 0\text{ V}$ ,  $V_{OUT} = 2\text{ Vpp}$ ,  $R_F = 0\ \Omega$ ,  $R_L = 2\text{ k}\Omega$ ,  $G = 1\text{ V/V}$ , input and output referenced to mid-supply.  $T_A = 25^\circ\text{C}$



图 7-33. Harmonic Distortion vs Frequency



图 7-34. Harmonic Distortion vs Load Resistance

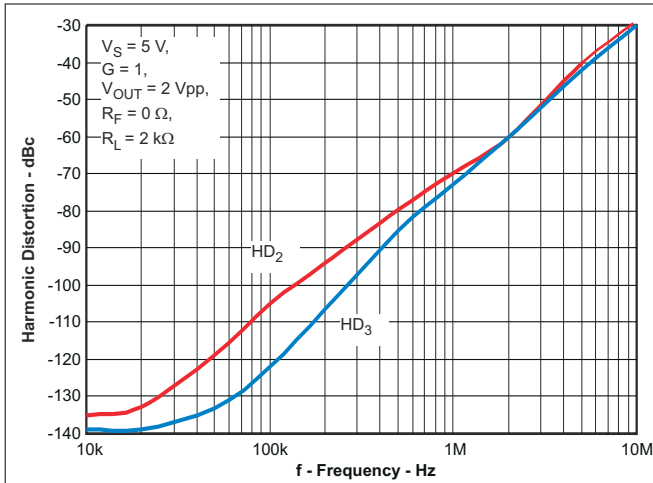

图 7-35. Harmonic Distortion vs Output Voltage

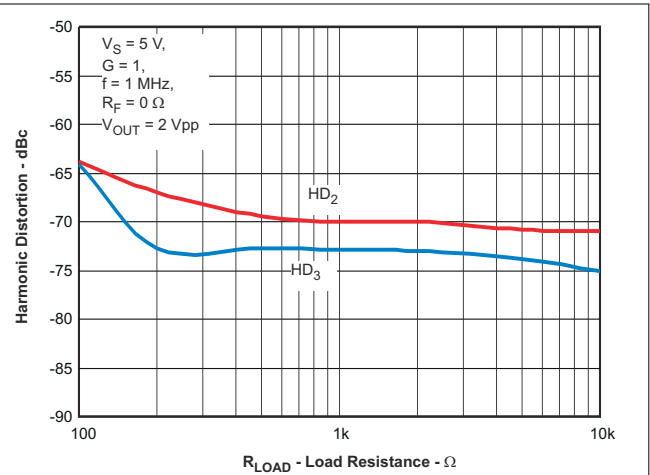

图 7-36. Harmonic Distortion vs Gain

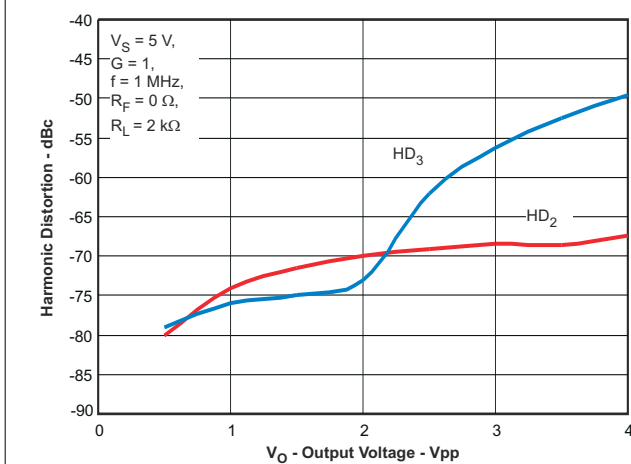

图 7-37. Output Voltage Swing vs Load Resistance

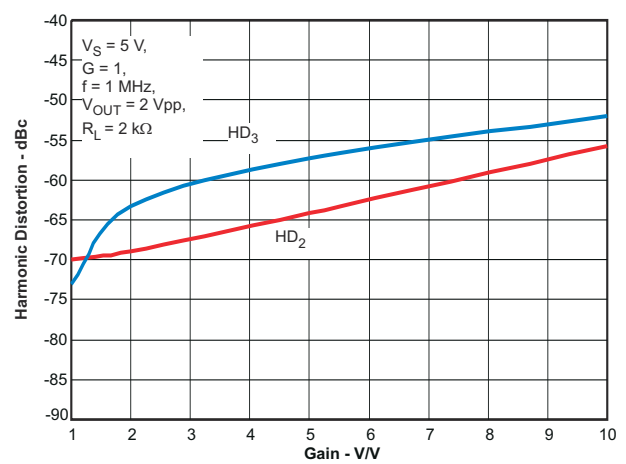

图 7-38. Output Saturation Voltage vs Load Current

### Typical Characteristics: $V_S = 5\text{ V}$

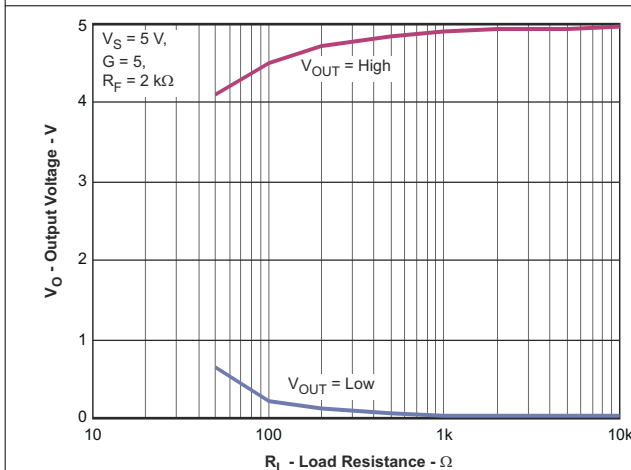
Test conditions unless otherwise noted:  $V_{S+} = +5\text{ V}$ ,  $V_{S-} = 0\text{ V}$ ,  $V_{OUT} = 2\text{ Vpp}$ ,  $R_F = 0\ \Omega$ ,  $R_L = 2\text{ k}\Omega$ ,  $G = 1\text{ V/V}$ , input and output referenced to mid-supply.  $T_A = 25^\circ\text{C}$

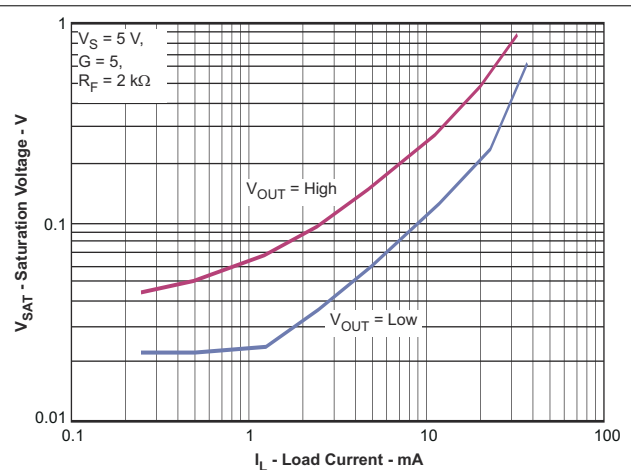

图 7-39. Output Impedance vs Frequency



图 7-40. Frequency Response With Capacitive Load

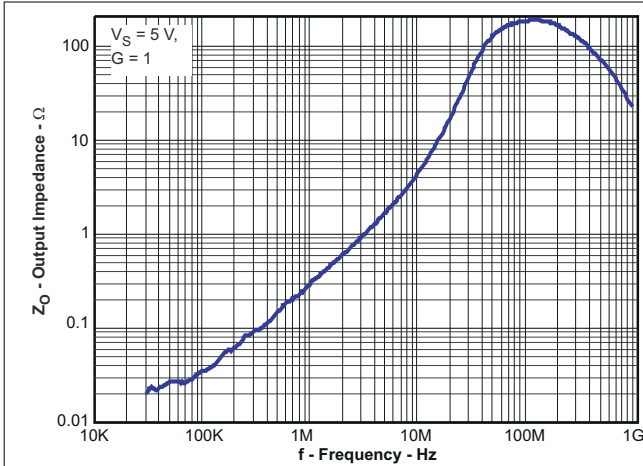

图 7-41. Series Output Resistor vs Capacitive Load

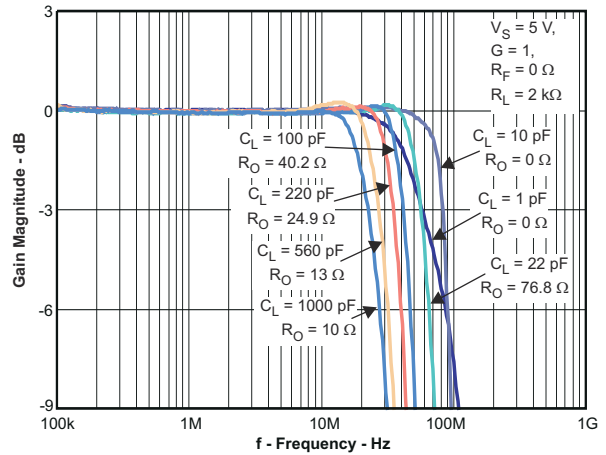

图 7-42. Input Referred Noise vs Frequency

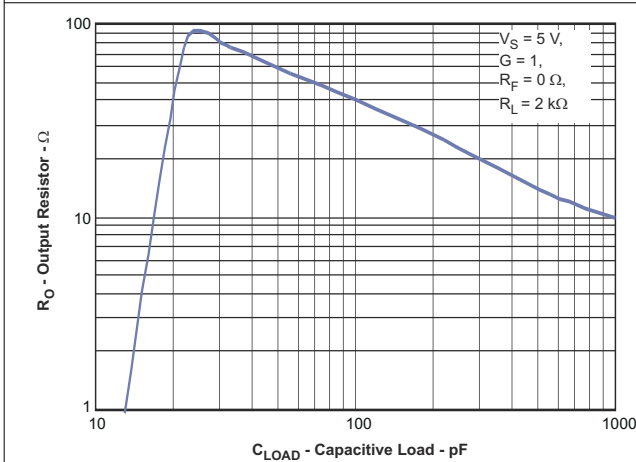

图 7-43. Open-Loop Gain vs Frequency

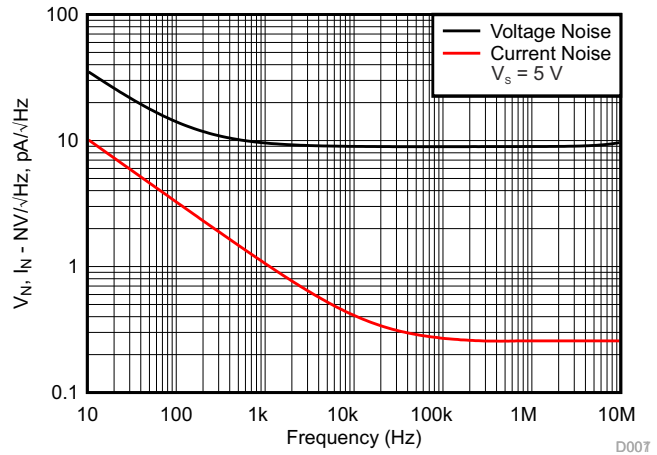

图 7-44. Common-Mode/Power Supply Rejection Ratios vs Frequency

### Typical Characteristics: $V_S = 5\text{ V}$

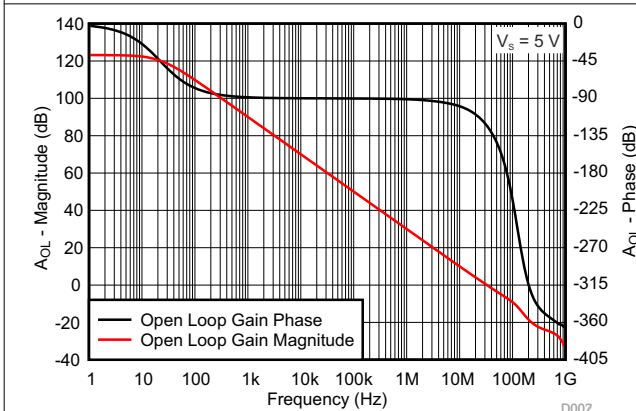
Test conditions unless otherwise noted:  $V_{S+} = +5\text{ V}$ ,  $V_{S-} = 0\text{ V}$ ,  $V_{OUT} = 2\text{ Vpp}$ ,  $R_F = 0\ \Omega$ ,  $R_L = 2\text{ k}\Omega$ ,  $G = 1\text{ V/V}$ , input and output referenced to mid-supply.  $T_A = 25^\circ\text{C}$

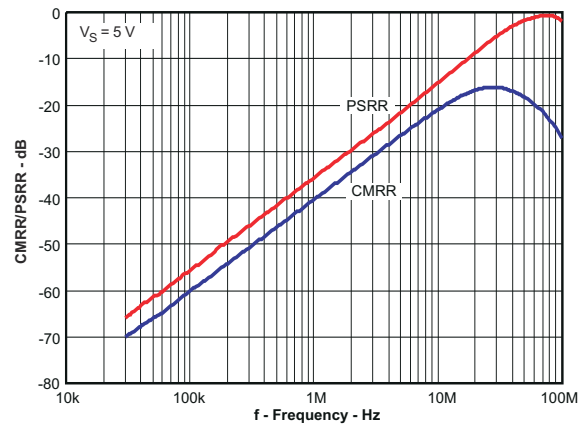

图 7-45. Crosstalk vs Frequency



图 7-46. Power Down Response

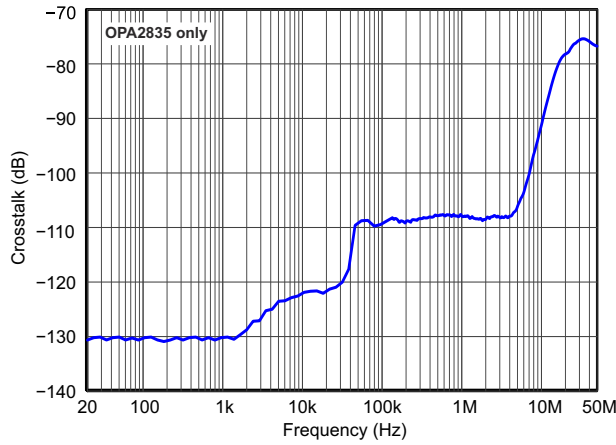

图 7-47. Input Offset Voltage

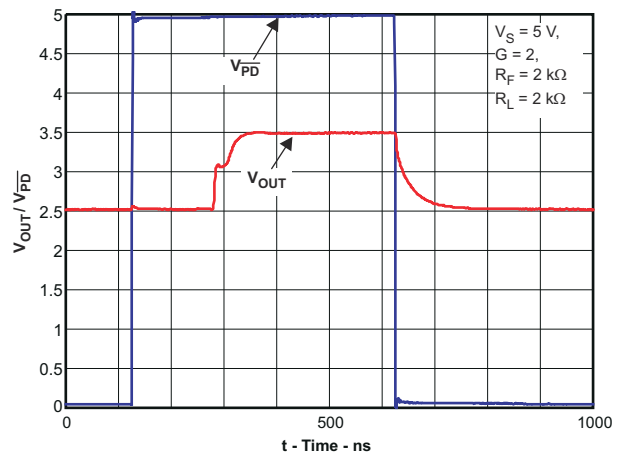

图 7-48. Input Offset Voltage vs Free-Air Temperature

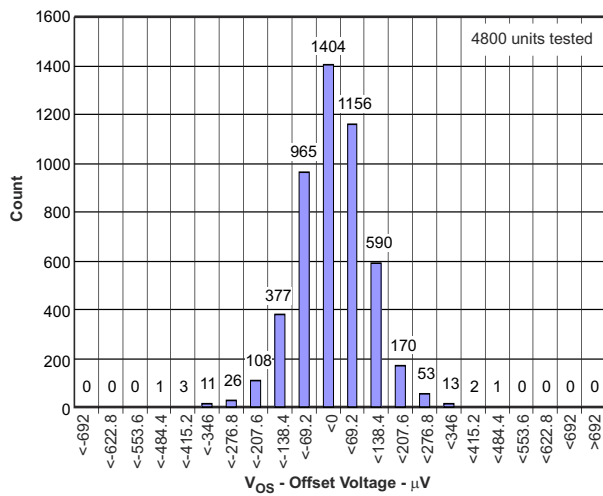

图 7-49. Input Offset Voltage Drift

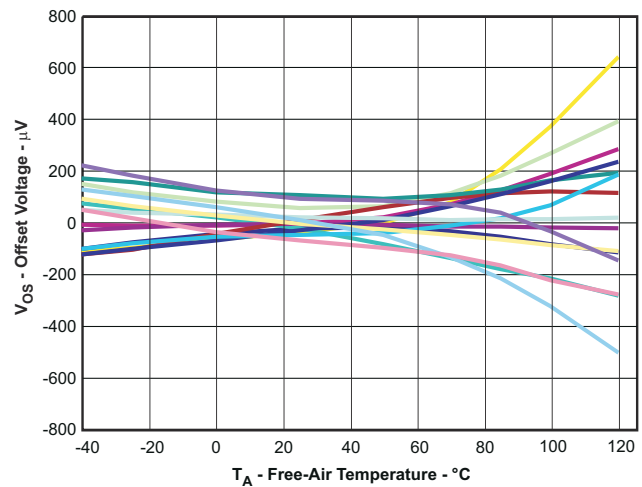

图 7-50. Input Offset Current

### Typical Characteristics: $V_S = 5\text{ V}$

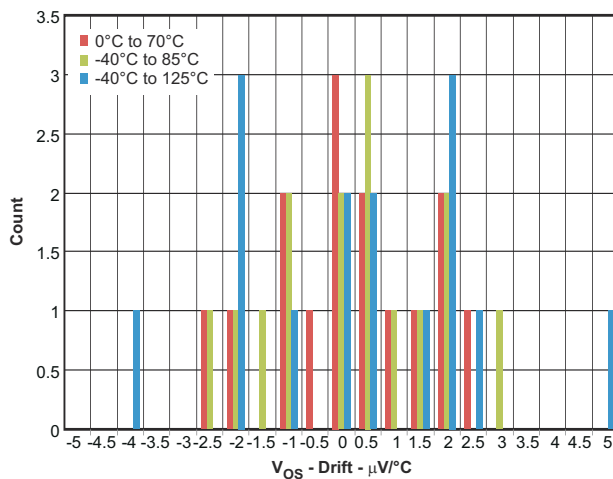
Test conditions unless otherwise noted:  $V_{S+} = +5\text{ V}$ ,  $V_{S-} = 0\text{ V}$ ,  $V_{OUT} = 2\text{ Vpp}$ ,  $R_F = 0\ \Omega$ ,  $R_L = 2\text{ k}\Omega$ ,  $G = 1\text{ V/V}$ , input and output referenced to mid-supply.  $T_A = 25^\circ\text{C}$

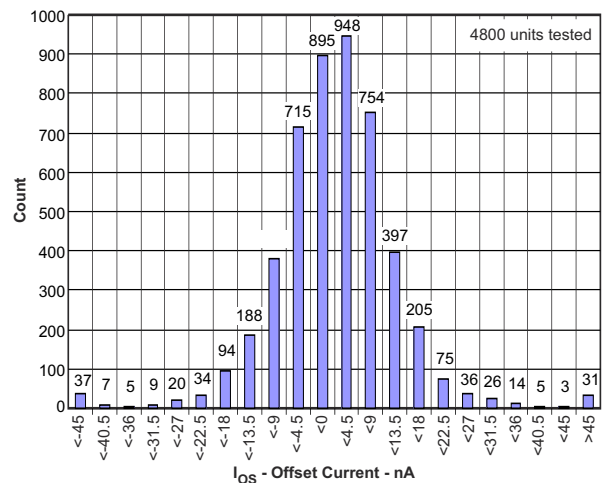
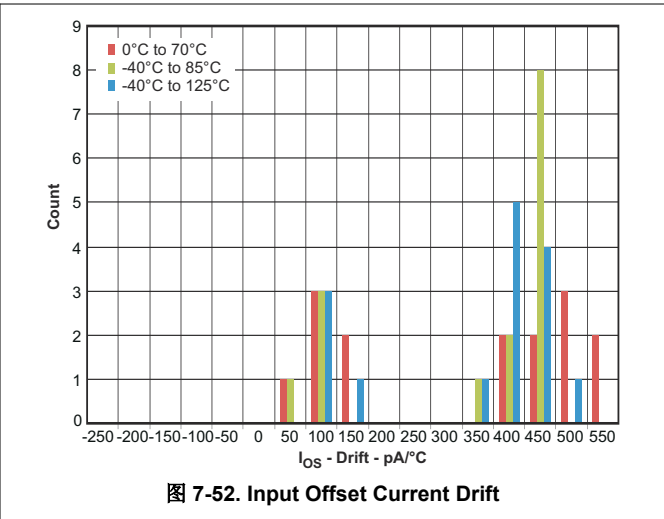
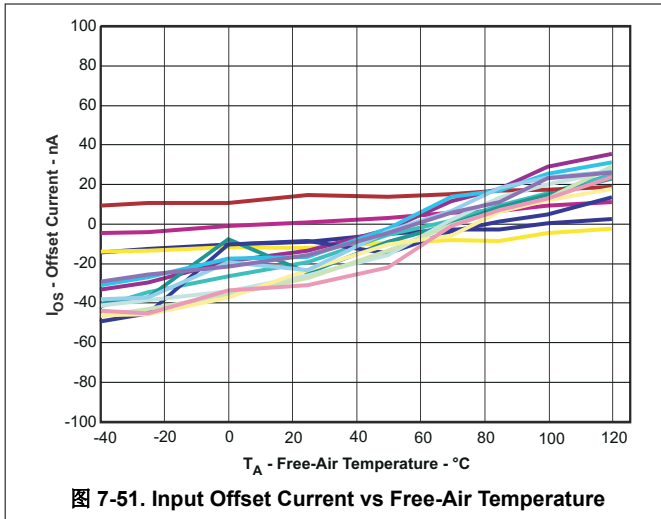

## 8 Detailed Description

### 8.1 Overview

The OPAx835 family of bipolar-input operational amplifiers offers excellent bandwidth of 56 MHz with ultra-low THD of 0.00003% at 1 kHz. The device can swing to within 200 mV of the supply rails while driving a 2-k $\Omega$  load. The input common-mode of the amplifier can swing to 200 mV below the negative supply rail. This level of performance is achieved at 250  $\mu$ A of quiescent current per amplifier channel.

### 8.2 Functional Block Diagram



图 8-1. Noninverting Amplifier



图 8-2. Inverting Amplifier

### 8.3 Feature Description

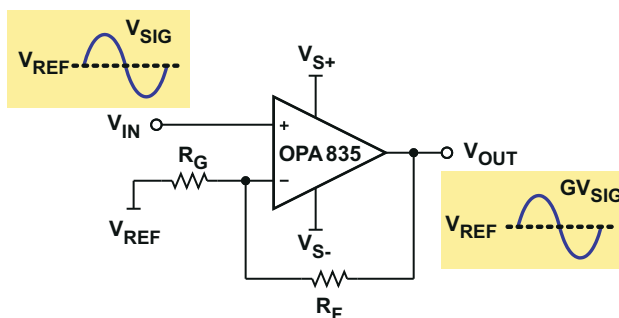
#### 8.3.1 Input Common-Mode Voltage Range

When the primary design goal is a linear amplifier, with high CMRR, it is important to not violate the input common-mode voltage range ( $V_{ICR}$ ) of an op amp.

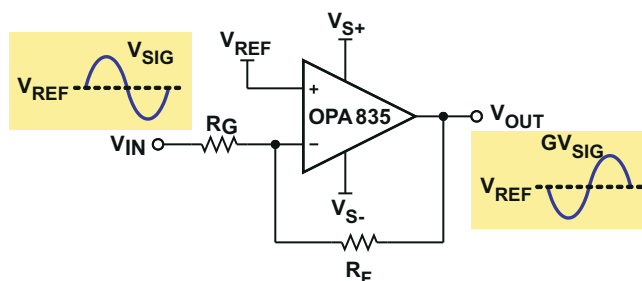
The common-mode input range specifications in the table data use CMRR to set the limit. The limits are selected to ensure CMRR will not degrade more than 3 dB below the CMRR limit if the input voltage is kept within the specified range. The limits cover all process variations, and most parts will be better than specified. The typical specifications are 0.2 V below the negative rail and 1.1 V below the positive rail.

Assuming the op amp is in linear operation, the voltage difference between the input pins is small (ideally 0 V); and the input common-mode voltage is analyzed at either input pin with the other input pin assumed to be at the same potential. The voltage at  $V_{IN+}$  is simple to evaluate. In noninverting configuration, 图 8-1, the input signal,  $V_{IN}$ , must not violate the  $V_{ICR}$ . In inverting configuration, as shown in 图 8-2, the reference voltage,  $V_{REF}$ , must be within the  $V_{ICR}$ .

The input voltage limits have fixed headroom to the power rails and track the power supply voltages. For one 5-V supply, the linear input voltage ranges from -0.2 V to 3.9 V and -0.2 V to 1.6 V for a 2.7-V supply. The delta headroom from each power supply rail is the same in either case: -0.2 V and 1.1 V.

### 8.3.2 Output Voltage Range

The OPA835 and OPA2835 devices are rail-to-rail output (RRO) op amps. Rail-to-rail output typically means that the output voltage swings within a couple hundred millivolts of the supply rails. There are different ways to specify this: one is with the output still in linear operation and another is with the output saturated. Saturated output voltages are closer to the power supply rails than linear outputs, but the signal is not a linear representation of the input. Linear output is a better representation of how well a device performs when used as a linear amplifier. Saturation and linear operation limits are affected by the output current, where higher currents lead to more loss in the output transistors.

The specification tables list linear and saturated output voltage specifications with 2-k $\Omega$  load. [Output Voltage Swing vs Load Resistance](#) and [Output Voltage Swing vs Load Resistance](#) show saturated voltage-swing limits versus output load resistance, and [Output Saturation Voltage vs Load Current](#) and [Output Saturation Voltage vs Load Current](#) show the output saturation voltage versus load current. Given a light load, the output voltage limits have nearly constant headroom to the power rails and track the power supply voltages. For example, with a 2-k $\Omega$  load and a single 5-V supply, the linear output voltage ranges from 0.15 V to 4.8 V and ranges from 0.15 V to 2.5 V for a 2.7-V supply. The delta from each power supply rail is the same in either case: 0.15 V and 0.2 V.

With devices like the OPA835 and OPA2835 where the input range is lower than the output range, typically the input will limit the available signal swing only in noninverting gain of 1. Signal swing in noninverting configurations in gains  $> +1$  and inverting configurations in any gain is typically limited by the output voltage limits of the op amp.

### 8.3.3 Power-Down Operation

The OPA835 and OPA2835 devices include a power-down mode. Under logic control, the amplifiers can switch from normal operation to a standby current of  $< 1.5 \mu\text{A}$ . When the  $\overline{\text{PD}}$  pin is connected high, the amplifier is active. Connecting  $\overline{\text{PD}}$  pin low disables the amplifier and places the output in a high-impedance state. When the amplifier is configured as a unity-gain buffer, the output stage is in a high dc-impedance state. To protect the input stage of the amplifier, the devices use internal, back-to-back ESD diodes between the inverting and noninverting input pins. This configuration creates a parallel low-impedance path from the amplifier output to the noninverting pin when the differential voltage between the pins exceeds a diode voltage drop. When the op amp is configured in other gains, the feedback (RF) and gain (RG) resistor network forms a parallel load.

The  $\overline{\text{PD}}$  pin must be actively driven high or low and must not be left floating. If the power-down mode is not used,  $\overline{\text{PD}}$  must be tied to the positive supply rail.

$\overline{\text{PD}}$  logic states are TTL with reference to the negative supply rail,  $V_{S-}$ . When the op amp is powered from a single-supply and ground, driven from logic devices with similar  $V_{\text{DD}}$  voltages to the op amp do not require any special consideration. When the op amp is powered from a split supply, with  $V_{S-}$  below ground, an open-collector type of interface with a pullup resistor is more appropriate. Pullup resistor values must be lower than 100 k $\Omega$ . Additionally, the drive logic must be negated due to the inverting action of an open-collector gate.

### 8.3.4 Low-Power Applications and the Effects of Resistor Values on Bandwidth

The OPA835 and OPA2835 devices are designed for the nominal value of  $R_F$  to be 2 k $\Omega$  in gains other than  $+1$ . This gives excellent distortion performance, maximum bandwidth, best flatness, and best pulse response. It also loads the amplifier. For example; in gain of 2 with  $R_F = R_G = 2 \text{ k}\Omega$ ,  $R_G$  to ground, and  $V_{\text{OUT}} = 4 \text{ V}$ , 1 mA of current will flow through the feedback path to ground. In gain of  $+1$ ,  $R_G$  is open and no current will flow to ground. In low-power applications, it is desirable to reduce the current in the feedback path by increasing the gain-setting resistors values. Using larger value gain resistors has two primary side effects (other than lower power) due to their interaction with parasitic circuit capacitance.

- Lowers the bandwidth
- Lowers the phase margin
  - This causes peaking in the frequency response
  - This causes overshoot and ringing in the pulse response

图 8-3 shows the small-signal frequency response on OPA835EVM for noninverting gain of 2 with  $R_F$  and  $R_G$  equal to  $2\text{ k}\Omega$ ,  $10\text{ k}\Omega$ , and  $100\text{ k}\Omega$ . The test was done with  $R_L = 2\text{ k}\Omega$ . Due to loading effects of  $R_L$ , lower  $R_L$  values may reduce the peaking, but higher values will not have a significant effect.



图 8-3. Frequency Response With Various Gain-Setting Resistor Values

As expected, larger value gain resistors cause lower bandwidth and peaking in the response (peaking in frequency response is synonymous with overshoot and ringing in pulse response). Adding 1-pF capacitors in parallel with  $R_F$  helps compensate the phase margin and restores flat frequency response. 图 8-4 shows the test circuit.

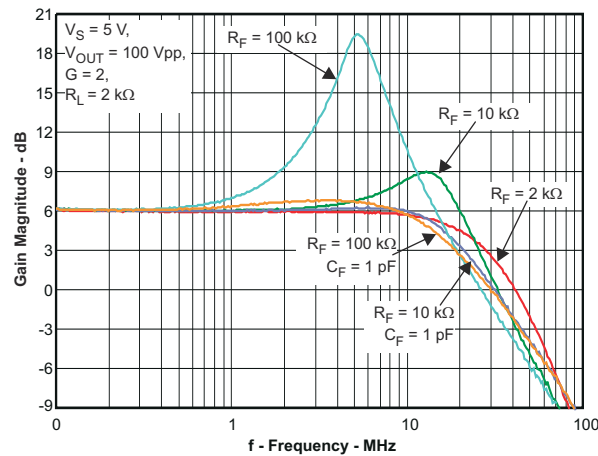

图 8-4.  $G = 2$  Test Circuit for Various Gain-Setting Resistor Values

### 8.3.5 Driving Capacitive Loads

The OPA835 and OPA2835 devices drive up to a nominal capacitive load of  $10\text{ pF}$  on the output with no special consideration. When driving capacitive loads greater than  $10\text{ pF}$ , TI recommends using a small resistor ( $R_O$ ) in series with the output as close to the device as possible. Without  $R_O$ , output capacitance interacts with the output impedance of the amplifier causing phase shift in the loop gain of the amplifier that will reduce the phase margin. This will cause peaking in the frequency response and overshoot and ringing in the pulse response. Interaction with other parasitic elements may lead to instability or oscillation. Inserting  $R_O$  will isolate the phase shift from the loop gain path and restore the phase margin; however  $R_O$  can limit the bandwidth slightly.

图 8-5 shows the test circuit and [Series Output Resistor vs Capacitive Load](#) shows the recommended values of  $R_O$  versus capacitive loads,  $C_L$ . See [Frequency Response With Capacitive Load](#) for the frequency responses with various values.

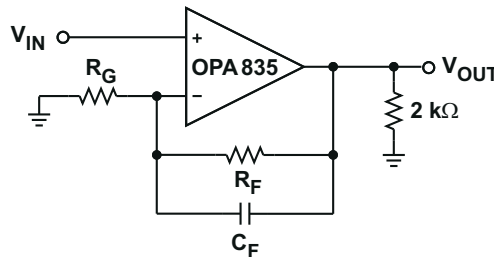
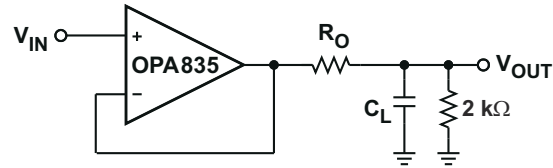
图 8-5.  $R_O$  versus  $C_L$  Test Circuit

## 8.4 Device Functional Modes

### 8.4.1 Split-Supply Operation ( $\pm 1.25$ V to $\pm 2.75$ V)

To facilitate testing with common lab equipment, the OPA835 EVM ( see [OPA835DBV and OPA836DBV EVM User's Guide](#) (SLOU314) ) is built to allow split-supply operation. This configuration eases lab testing because the mid-point between the power rails is ground, and most signal generators, network analyzers, oscilloscopes, spectrum analyzers and other lab equipment have inputs and outputs with a ground reference.

图 8-6 shows a simple noninverting configuration analogous to 图 8-1 with  $\pm 2.5$ -V supply and  $V_{REF}$  equal to ground. The input and output will swing symmetrically around ground. For ease of use, split supplies are preferred in systems where signals swing around ground.



图 8-6. Split-Supply Operation

### 8.4.2 Single-Supply Operation (2.5 V to 5.5 V)

Often, newer systems use a single power supply to improve efficiency and reduce the cost of the power supply. OPA835 and OPA2835 devices are designed for use with single-supply power operation and can be used with single-supply power with no change in performance from split supply, as long as the input and output are biased within the linear operation of the device.

To change the circuit from split supply to single-supply, level shift all voltages by  $\frac{1}{2}$  the difference between the power supply rails. For example, changing from  $\pm 2.5$ -V split supply to 5-V single-supply is shown in 图 8-7.

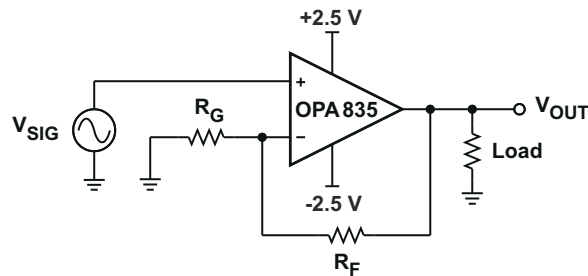

图 8-7. Single-Supply Concept

A practical circuit will have an amplifier or other circuit providing the bias voltage for the input, and the output of this amplifier stage provides the bias for the next stage.

图 8-8 shows a typical noninverting amplifier circuit. With 5-V single-supply, a mid-supply reference generator is needed to bias the negative side through  $R_G$ . To cancel the voltage offset that would otherwise be caused by the input bias currents,  $R_1$  is selected to be equal to  $R_F$  in parallel with  $R_G$ . For example if gain of 2 is required and  $R_F = 2\text{ k}\Omega$ , select  $R_G = 2\text{ k}\Omega$  to set the gain, and  $R_1 = 1\text{ k}\Omega$  for bias current cancellation. The value for C is dependent on the reference, and TI recommends a value of at least  $0.1\text{ }\mu\text{F}$  to limit noise.

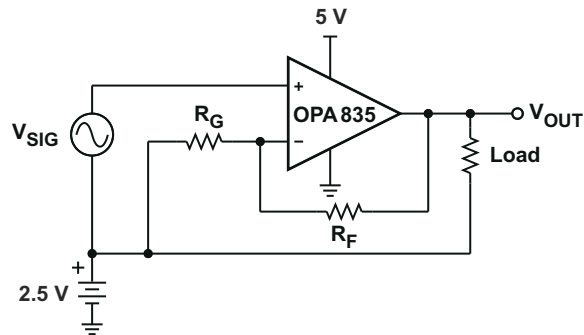

图 8-8. Noninverting Single Supply With Reference

图 8-9 shows a similar noninverting single-supply scenario with the reference generator replaced by the Thevenin equivalent using resistors and the positive supply.  $R_G'$  and  $R_G''$  form a resistor divider from the 5-V supply and are used to bias the negative side with the parallel sum equal to the equivalent  $R_G$  to set the gain. To cancel the voltage offset that would otherwise be caused by the input bias currents,  $R_1$  is selected to be equal to  $R_F$  in parallel with  $R_G'$  in parallel with  $R_G''$  ( $R_1 = R_F \parallel R_G' \parallel R_G''$ ). For example, if a gain of 2 is required and  $R_F = 2\text{ k}\Omega$ , selecting  $R_G' = R_G'' = 4\text{ k}\Omega$  gives equivalent parallel sum of  $2\text{ k}\Omega$ , sets the gain to 2, and references the input to mid supply (2.5 V).  $R_1$  is set to  $1\text{ k}\Omega$  for bias current cancellation. The resistor divider costs less than the 2.5V reference in 图 8-8 but may increase the current from the 5-V supply.

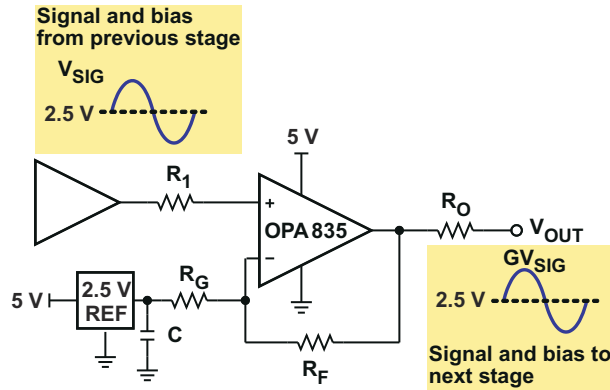

图 8-9. Noninverting Single Supply With Resistors

图 8-10 shows a typical inverting-amplifier circuit. With a 5-V single-supply, a mid-supply reference generator is needed to bias the positive side through  $R_1$ . To cancel the voltage offset that would otherwise be caused by the input bias currents,  $R_1$  is selected to be equal to  $R_F$  in parallel with  $R_G$ . For example, if a gain of  $-2$  is required and  $R_F = 2\text{ k}\Omega$ , select  $R_G = 1\text{ k}\Omega$  to set the gain and  $R_1 = 667\text{ }\Omega$  for bias current cancellation. The value for C is dependent on the reference, but TI recommends a value of at least  $0.1\text{ }\mu\text{F}$  to limit noise into the op amp.

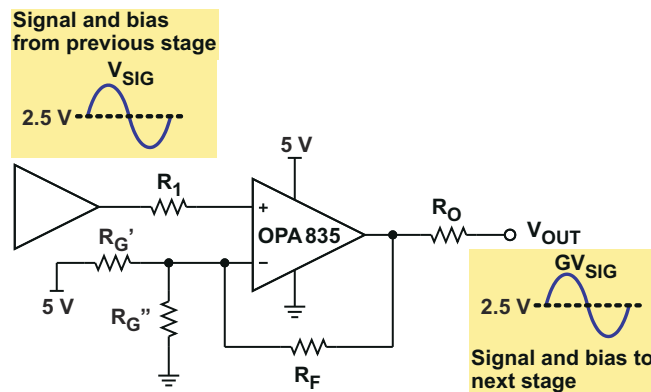

图 8-10. Inverting Single Supply With Reference

图 8-11 shows a similar inverting single-supply scenario with the reference generator replaced by the Thevenin equivalent using resistors and the positive supply.  $R_1$  and  $R_2$  form a resistor divider from the 5-V supply and are used to bias the positive side. To cancel the voltage offset that would otherwise be caused by the input bias currents, set the parallel sum of  $R_1$  and  $R_2$  equal to the parallel sum of  $R_F$  and  $R_G$ .  $C$  must be added to limit coupling of noise into the positive input. For example, if gain of  $-2$  is required and  $R_F = 2\text{ k}\Omega$ , select  $R_G = 1\text{ k}\Omega$  to set the gain.  $R_1 = R_2 = 667\ \Omega$  for mid-supply voltage bias and for op-amp input-bias current cancellation. A good value for  $C$  is  $0.1\ \mu\text{F}$ . The resistor divider costs less than the 2.5-V reference in 图 8-10 but may increase the current from the 5-V supply.

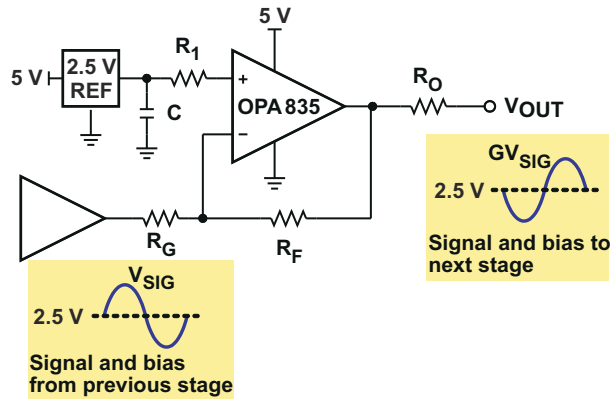

图 8-11. Inverting Single Supply With Resistors

## 9 Application and Implementation

### Note

Information in the following applications sections is not part of the TI component specification, and TI does not warrant its accuracy or completeness. TI's customers are responsible for determining suitability of components for their purposes, as well as validating and testing their design implementation to confirm system functionality.

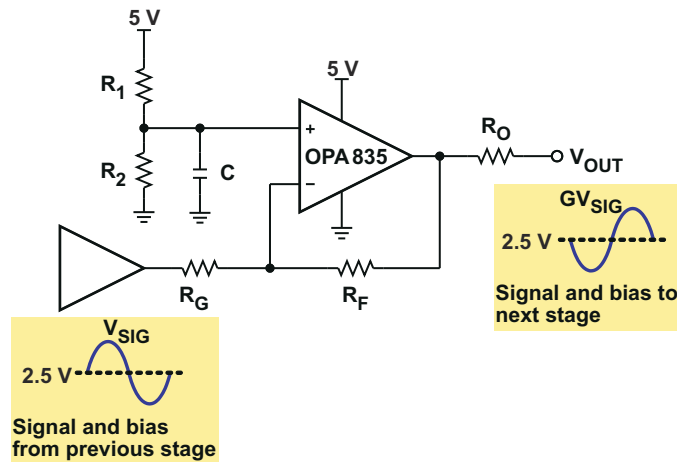
### 9.1 Application Information

#### 9.1.1 Noninverting Amplifier

The OPA835 and OPA2835 devices can be used as noninverting amplifiers with signal input to the noninverting input,  $V_{IN+}$ . A basic block diagram of the circuit is shown in [图 8-1](#).

If  $V_{IN} = V_{REF} + V_{SIG}$ , the amplifier output may be calculated according to [方程式 1](#).

$$V_{OUT} = V_{SIG} \left( 1 + \frac{R_F}{R_G} \right) + V_{REF} \quad (1)$$

The signal gain of the circuit is set by  $G = 1 + \frac{R_F}{R_G}$ , and  $V_{REF}$  provides a reference around which the input and output signals swing. Output signals are in-phase with the input signals.

The OPA835 and OPA2835 devices are designed for the nominal value of  $R_F$  to be 2 k $\Omega$  in gains other than +1. This gives excellent distortion performance, maximum bandwidth, best flatness, and best pulse response.  $R_F = 2$  k $\Omega$  must be used as a default unless other design goals require changing to other values. All test circuits used to collect data for this data sheet had  $R_F = 2$  k $\Omega$  for all gains other than +1. A gain of +1 is a special case where  $R_F$  is shorted and  $R_G$  is left open.

#### 9.1.2 Inverting Amplifier

The OPA835 and OPA2835 devices can be used as inverting amplifiers with signal input to the inverting input,  $V_{IN-}$ , through the gain-setting resistor  $R_G$ . A basic block diagram of the circuit is shown in [图 8-2](#).

If  $V_{IN} = V_{REF} + V_{SIG}$ , the output of the amplifier may be calculated according to [方程式 2](#).

$$V_{OUT} = V_{SIG} \left( \frac{-R_F}{R_G} \right) + V_{REF} \quad (2)$$

The signal gain of the circuit  $G = \frac{-R_F}{R_G}$  and  $V_{REF}$  provides a reference point around which the input and output signals swing. Output signals are 180° out-of-phase with the input signals. The nominal value of  $R_F$  must be 2 k $\Omega$  for inverting gains.

#### 9.1.3 Instrumentation Amplifier

[图 9-1](#) is an instrumentation amplifier that combines the high input impedance of the differential-to-differential amplifier circuit and the common-mode rejection of the differential-to-single-ended amplifier circuit. This circuit is often used in applications where high input impedance is required (such as taps from a differential line) or in cases where the signal source is a high impedance.

If  $V_{IN+} = V_{CM} + V_{SIG+}$  and  $V_{IN-} = V_{CM} + V_{SIG-}$ , the output of the amplifier may be calculated according to [方程式 3](#).

$$V_{OUT} = (V_{IN+} - V_{IN-}) \times \left(1 + \frac{2R_{F1}}{R_{G1}}\right) \left(\frac{R_{F2}}{R_{G2}}\right) + V_{REF} \quad (3)$$

$$G = \left(1 + \frac{2R_{F1}}{R_{G1}}\right) \left(\frac{R_{F2}}{R_{G2}}\right)$$

The signal gain of the circuit is  $G$ .  $V_{CM}$  is rejected, and  $V_{REF}$  provides a level shift around which the output signal swings. The single-ended output signal is in-phase with the differential input signal.



图 9-1. Instrumentation Amplifier

Integrated solutions are available, but the OPA835 device provides a much lower-power, high-frequency solution. For best CMRR performance, resistors must be matched. A good rule of thumb is  $CMRR \approx$  the resistor tolerance; so 0.1% tolerance will provide approximately 60-dB CMRR.

#### 9.1.4 Attenuators

The noninverting circuit shown in 图 8-1 has a minimum gain of 1. To implement attenuation, a resistor divider can be placed in series with the positive input, and the amplifier set for a gain of 1 by shorting  $V_{OUT}$  to  $V_{IN-}$  and removing  $R_G$ . Because the op amp input is high impedance, the resistor divider sets the attenuation.

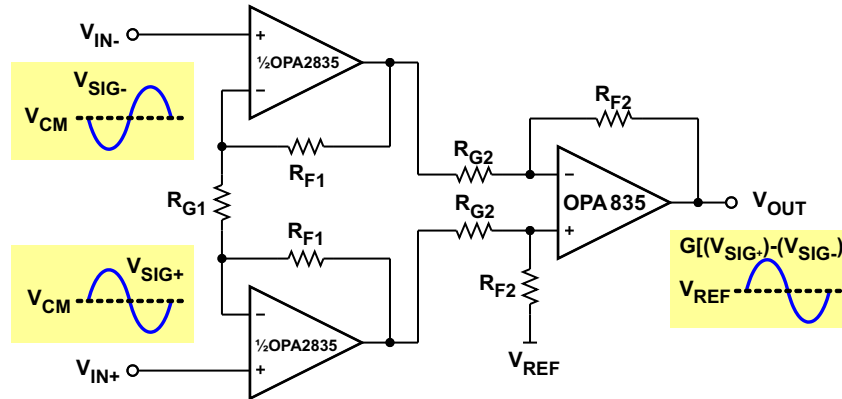
The inverting circuit of 图 8-2 is used as an attenuator by making  $R_G$  larger than  $R_F$ . The attenuation is the resistor ratio. For example, a 10:1 attenuator can be implemented with  $R_F = 2 \text{ k}\Omega$  and  $R_G = 20 \text{ k}\Omega$ .

#### 9.1.5 Single-Ended to Differential Amplifier

图 9-2 shows an amplifier circuit that converts single-ended signals to differential signals and provides gain and level shifting. This circuit can convert signals to differential in applications such as driving Cat5 cabling or driving differential-input SAR and  $\Delta \Sigma$  ADCs.

By setting  $V_{IN} = V_{REF} + V_{SIG}$ , then the output of the amplifier may be calculated according to 方程式 4.

$$V_{OUT+} = G \times V_{IN} + V_{REF} \quad \text{and} \quad V_{OUT-} = -G \times V_{IN} + V_{REF} \quad \text{Where: } G = 1 + \frac{R_F}{R_G} \quad (4)$$

The differential-signal gain of the circuit is  $2 \times G$ , and  $V_{REF}$  provides a reference around which the output signal swings. The differential output signal is in-phase with the single-ended input signal.



图 9-2. Single-Ended to Differential Amplifier

Line termination on the output can be accomplished with resistors  $R_O$ . The differential impedance seen from the line will be  $2 \times R_O$ . For example, if 100- $\Omega$  Cat5 cable is used with double termination, the amplifier is typically set for a differential gain of 2 V/V (6 dB) with  $R_F = 0 \Omega$  (short)  $R_G = \infty \Omega$  (open),  $2R = 2 \text{ k}\Omega$ ,  $R_1 = 0 \Omega$ ,  $R = 1 \text{ k}\Omega$  to balance the input bias currents, and  $R_O = 49.9 \Omega$  for output line termination. This configuration is shown in 图 9-3.

For driving a differential-input ADC the situation is similar, but the output resistors,  $R_O$ , are selected with a capacitor across the ADC input for optimum filtering and settling-time performance.

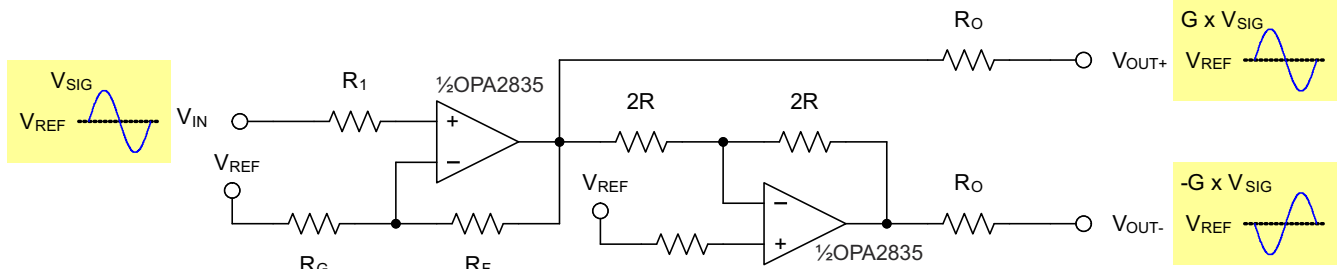

图 9-3. Cat5 Line Driver With Gain = 2 V/V (6 dB)

### 9.1.6 Differential to Single-Ended Amplifier

图 9-4 shows a differential amplifier that converts differential signals to single-ended and provides gain (or attenuation) and level shifting. This circuit can be used in applications like a line receiver for converting a differential signal from a Cat5 cable to a single-ended signal.

If  $V_{IN+} = V_{CM} + V_{SIG+}$  and  $V_{IN-} = V_{CM} + V_{SIG-}$ , then the output of the amplifier may be calculated according to 方程式 5.

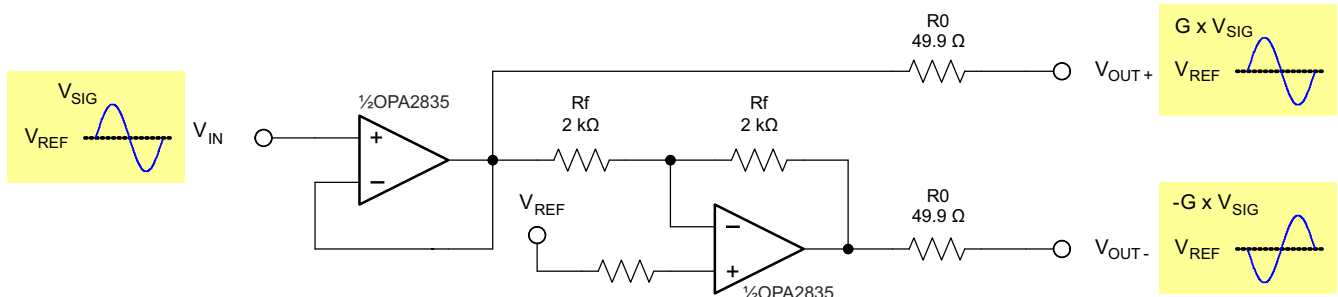
$$V_{OUT} = (V_{IN+} - V_{IN-}) \times \left( \frac{R_F}{R_G} \right) + V_{REF} \quad (5)$$

The signal gain of the circuit is  $G = \frac{R_F}{R_G}$ ,  $V_{CM}$  is rejected, and  $V_{REF}$  provides a level shift around which the output signal swings. The single-ended output signal is in-phase with the differential input signal.



图 9-4. Differential to Single-Ended Amplifier

Line termination can be accomplished by adding a shunt resistor across the VIN+ and VIN- inputs. The differential impedance is the shunt resistance in parallel with the input impedance of the amplifier circuit, which is usually much higher. For low gain and low line impedance, the resistor value to add is approximately the impedance of the line. For example, if a 100-Ω Cat5 cable is used with a gain of 1 amplifier and  $R_F = R_G = 2\text{ k}\Omega$ , adding a 100-Ω shunt across the input will give a differential impedance of 99 Ω, which is adequate for most applications.

For best CMRR performance, resistors must be matched. Assuming  $\text{CMRR} \approx$  the resistor tolerance, a 0.1% tolerance will provide about 60-dB CMRR.

### 9.1.7 Differential-to-Differential Amplifier

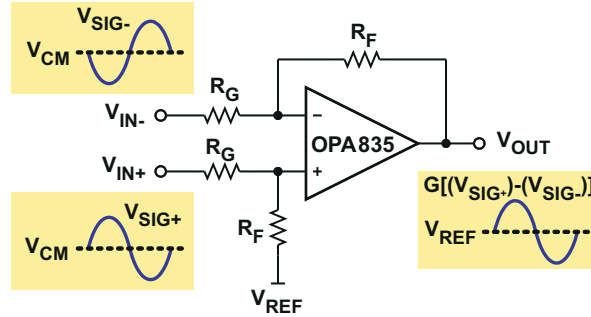
图 9-5 shows a differential amplifier that is used to amplify differential signals. This circuit has high input impedance and is used in differential line driver applications where the signal source is a high-impedance driver (for example, a differential DAC) that must drive a line.

If the user sets  $V_{IN\pm} = V_{CM} + V_{SIG\pm}$ , then the output of the amplifier may be calculated according to 方程式 6.

$$V_{OUT\pm} = V_{IN\pm} \times \left( 1 + \frac{2R_F}{R_G} \right) + V_{CM} \tag{6}$$

The signal gain of the circuit is  $G = 1 + \frac{2R_F}{R_G}$ , and  $V_{CM}$  passes with unity gain. The amplifier combines two noninverting amplifiers into one differential amplifier that shares the  $R_G$  resistor, which makes  $R_G$  effectively  $\frac{1}{2}$  its value when calculating the gain. The output signals are in-phase with the input signals.



图 9-5. Differential-to-Differential Amplifier

### 9.1.8 Gain Setting With OPA835 RUN Integrated Resistors

The OPA835 RUN package option includes integrated gain-setting resistors for the smallest possible footprint on a printed circuit board ( $\approx 2.00 \text{ mm} \times 2.00 \text{ mm}$ ). By adding circuit traces on the PCB, gains of +1, -1, -1.33, +2, +2.33, -3, +4, -4, +5, -5.33, +6.33, -7, +8 and inverting attenuations of -0.1429, -0.1875, -0.25, -0.33, -0.75 can be achieved.

图 9-6 shows a simplified view of how the OPA835IRUN integrated gain-setting network is implemented. 表 9-1 lists the required pin connections for various noninverting and inverting gains (reference 图 8-1 and 图 8-2). 表 9-2 lists the required pin connections for various attenuations using the inverting-amplifier architecture (reference 图 8-2). Due to ESD protection devices being used on all pins, the absolute maximum and minimum input voltage range,  $V_{S-} - 0.7 \text{ V}$  to  $V_{S+} + 0.7 \text{ V}$ , applies to the gain-setting resistors, and so attenuation of large input voltages will require external resistors to implement.

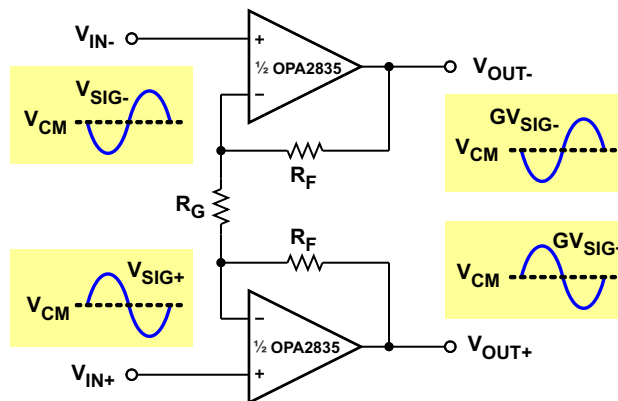
The gain-setting resistors are laser trimmed to 1% tolerance with nominal values of 2.4 k $\Omega$ , 1.8 k $\Omega$ , and 600  $\Omega$ . The gain-setting resistors have excellent temperature coefficient, and gain tracking is superior to using external gain-setting resistors. The 800- $\Omega$  resistor and 1.25-pF capacitor in parallel with the 2.4-k $\Omega$  gain-setting resistor provide compensation for best stability and pulse response.



图 9-6. OPA835IRUN Gain-Setting Network

表 9-1. Gain Settings

NONINVERTING GAIN (图 8-1)	INVERTING GAIN (图 8-2)	SHORT PINS	SHORT PINS	SHORT PINS	SHORT PINS
1 V/V (0 dB)	—	1 to 9			—
2 V/V (6.02 dB)	- 1 V/V (0 dB)	1 to 9	2 to 8	6 to GND	—
2.33 V/V (7.36 dB)	- 1.33 V/V (2.5 dB)	1 to 9	2 to 8	7 to GND	—
4 V/V (12.04 dB)	- 3 V/V (9.54 dB)	1 to 8	2 to 7	6 to GND	—
5 V/V (13.98 dB)	- 4 V/V (12.04 dB)	1 to 9	2 to 7 or 8	7 to 8	6 to GND
6.33 V/V (16.03 dB)	- 5.33 V/V (14.54 dB)	1 to 9	2 to 6 or 8	6 to 8	7 to GND
8 V/V (18.06 dB)	- 7 V/V (16.90 dB)	1 to 9	2 to 7	6 to GND	—

表 9-2. Attenuator Settings

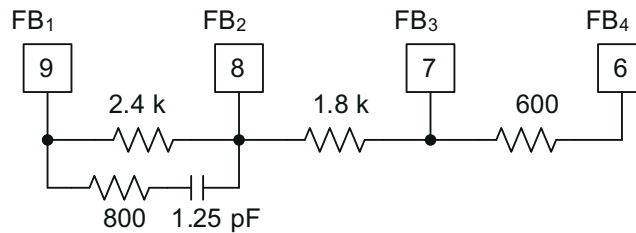
INVERTING GAIN (图 8-2)	SHORT PINS	SHORT PINS	SHORT PINS	SHORT PINS
- 0.75 V/V (- 2.5 dB)	1 to 7	2 to 8	9 to GND	—
- 0.333 V/V (- 9.54 dB)	1 to 6	2 to 7	8 to GND	—
- 0.25 V/V (- 12.04 dB)	1 to 6	2 to 7 or 8	7 to 8	9 to GND
- 0.1875 V/V (- 14.54 dB)	1 to 7	2 to 6 or 8	6 to 8	9 to GND
- 0.1429 V/V (- 16.90 dB)	1 to 6	2 to 7	9 to GND	—

### 9.1.9 Pulse Application With Single-Supply

For pulsed applications where the signal is at ground and pulses to a positive or negative voltage, the circuit bias-voltage considerations differ from those in an application with a signal that swings symmetrically about a reference point. 图 9-7 shows a circuit where the signal is at ground (0 V) and pulses to a positive value.



图 9-7. Noninverting Single Supply With Pulse

If the input signal pulses negative from ground, an inverting amplifier is more appropriate, as shown in 图 9-8. A key consideration in noninverting and inverting cases is that the input and output voltages are kept within the limits of the amplifier. Because the  $V_{ICR}$  of the OPA835 device includes the negative supply rail, the OPA835 op amp is well-suited for this application.

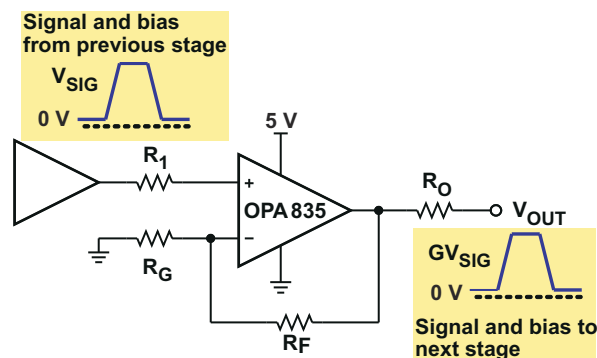

图 9-8. Inverting Single Supply With Pulse

### 9.1.10 ADC Driver Performance

The OPA835 device provides excellent performance when driving high-performance delta-sigma ( $\Delta\Sigma$ ) and successive-approximation-register (SAR) ADCs in low-power audio and industrial applications.

To show achievable performance, the OPA835 device is tested as the drive amplifier for the ADS8326 device. The ADS8326 device is a 16-bit, micro power, SAR ADC with pseudodifferential inputs and sample rates up to 250 kSPS. The device offers excellent noise and distortion performance in a small 8-pin SOIC or VSSOP (MSOP) package. Low power and small size make the ADS8326 and OPA835 devices an ideal solution for portable and battery-operated systems, remote data-acquisition modules, simultaneous multichannel systems, and isolated data acquisition.

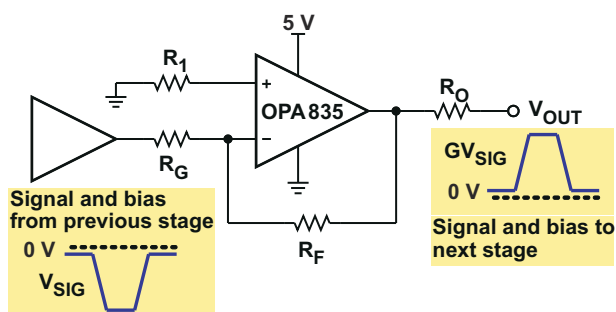
With the circuit shown in 图 9-9 to test the performance, 图 9-10 shows the spectral performance with a 10-kHz input frequency. The tabulated AC results are in 表 9-3.



图 9-9. OPA835 and ADS8326 Test Circuit



图 9-10. ADS8326 and OPA835 10-kHz FFT

表 9-3. AC Analysis

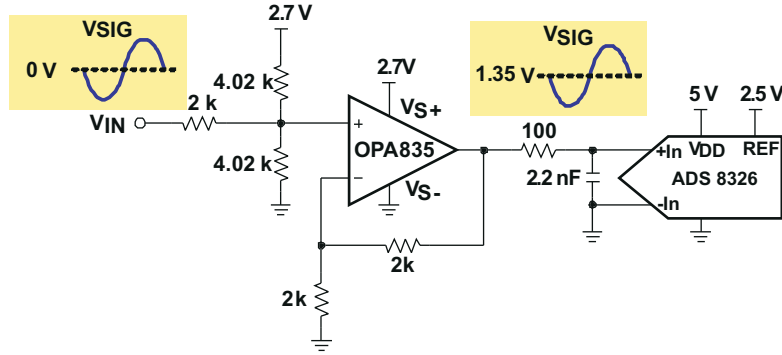
TONE (Hz)	SIGNAL (dBFS)	SNR (dBc)	THD (dBc)	SINAD (dBc)	SFDR (dBc)
10k	-0.85	81.9	-87.5	80.8	89.9

## 9.2 Typical Application

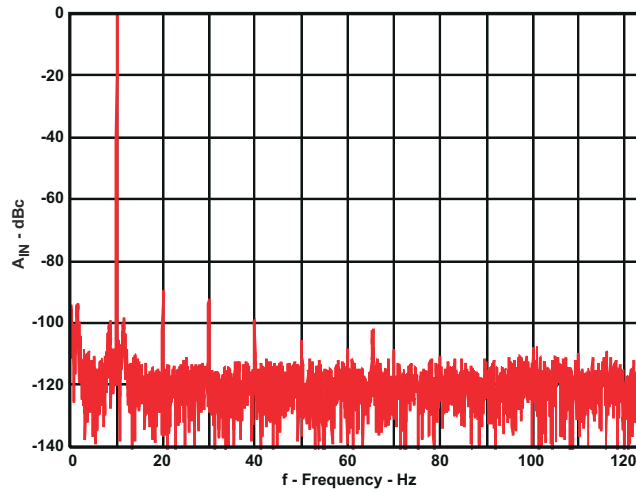
### 9.2.1 Audio Frequency Performance

The OPA835 and OPA2835 devices provide excellent audio performance with low quiescent power. To show performance in the audio band, an audio analyzer from Audio Precision (2700 series) tests THD+N and FFT at 1  $V_{RMS}$  output voltage.

OPA835 Audio Precision Analyzer Test Circuit shows the test circuit used for the audio-frequency performance application.

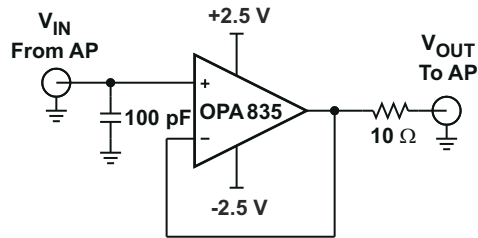

The 100-pF capacitor to ground on the input helped to decouple noise pick up in the lab and improved noise performance.

图 9-11. OPA835 Audio Precision Analyzer Test Circuit

### 9.2.1.1 Design Requirements

Design a low distortion, single-ended input to single-ended output audio amplifier using the OPA835 device. The 2700 series audio analyzer from Audio Precision is the signal source and the measurement system.

表 9-4. Design Requirements

CONFIGURATION	INPUT EXCITATION	PERFORMANCE TARGET	R <sub>LOAD</sub>
OPA835 Unity Gain Config.	1 KHz Tone Frequency	> 110 dBc SFDR	300 Ω and 100 KΩ

### 9.2.1.2 Detailed Design Procedure

The OPA835 device is tested in this application in a unity-gain buffer configuration. A buffer configuration is selected as the configuration maximizes the loop gain of the amplifier configuration. At higher closed-loop gains, the loop gain of the circuit reduces, which results in degraded harmonic distortion. The relationship between distortion and closed loop gain at a fixed input frequency can be seen in [Harmonic Distortion vs Gain](#) in [Typical Characteristics: VS = 5 V](#). The test was performed under varying output-load conditions using a resistive load of 300 Ω and 100 KΩ. [Harmonic Distortion vs Load Resistance](#) shows the distortion performance of the amplifier versus the output resistive load. Output loading, output swing, and closed-loop gain play a key role in determining the distortion performance of the amplifier.

#### Note

The 100-pF capacitor to ground on the input helped to decouple noise pickup in the lab and improved noise performance.

The Audio Precision was configured as a single-ended output in this application circuit. In applications where a differential output is available, the OPA835 device can be configured as a differential to single-ended amplifier as shown in [图 9-4](#). Power supply bypassing is critical to reject noise from the power supplies. A 2.2-μF power-supply decoupling capacitor must be placed within two inches of the device and can be shared with other op amps on the same board. A 0.1-μF decoupling capacitor must be placed as close to the power supply pins as possible, preferably within 0.1 inch. For split supply, a capacitor is required for both supplies. A 0.1-μF capacitor placed directly between the supplies is also beneficial for improving system noise performance. If the output load is heavy, from 16 Ω to 32 Ω, amplifier performance could begin to degrade. To drive such heavy loads, both channels of the OPA2835 device can be paralleled with the outputs isolated with 1-Ω resistors to reduce the loading effects.

### 9.2.1.3 Application Curves

A 10- $\Omega$  series resistor can be inserted between the capacitor and the noninverting pin to isolate the capacitance.

图 9-12 shows the THD+N performance with 100-k $\Omega$  and 300- $\Omega$  loads, and with no weighting and A-weighting. With no weighting, the THD+N performance is dominated by the noise for both loads. A-weighting provides filtering that improves the noise so a larger difference can be seen between the loads due to more distortion with  $R_L = 300 \Omega$ .

图 9-13 and 图 9-14 show FFT output with a 1-kHz tone and 100-k $\Omega$  and 300- $\Omega$  loads. To show relative performance of the device versus the test set, one channel has the OPA835 device in-line between generator output and analyzer input, and the other channel is in “Gen Mon” loopback mode, which internally connects the signal generator to the analyzer input. With 100-k $\Omega$  load (see 图 9-13), the curves are indistinguishable from each other except for noise, which means the OPA835 device cannot be directly measured. With a 300- $\Omega$  load as shown in 图 9-14, the main difference between the curves is the OPA835 device due to the higher even-order harmonics. The test-set performance masks the odd-order harmonics.



图 9-12. OPA835 1  $V_{RMS}$  20 Hz to 80 kHz THD+N



图 9-13. OPA835 and AP Gen Mon 1-kHz FFT Plot;  $V_{OUT} = 1 V_{RMS}$ ,  $R_L = 100 k\Omega$

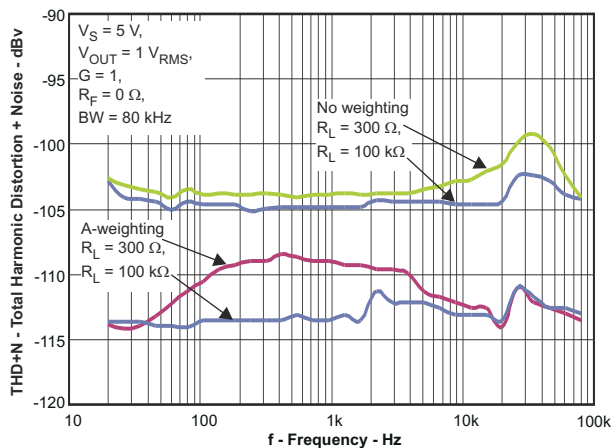

图 9-14. OPA835 and AP Gen Mon 1kHz FFT Plot;  $V_{OUT} = 1 V_{RMS}$ ,  $R_L = 300 \Omega$

### 9.2.2 Active Filters

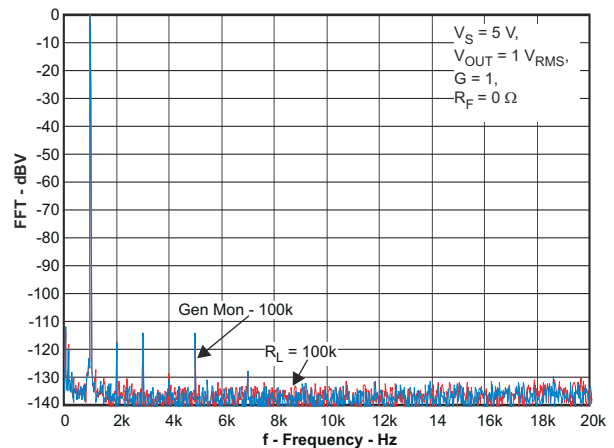
The OPA835 and OPA2835 devices are good choices for active filters. 图 9-16 and 图 9-15 show MFB and Sallen-Key circuits designed using the *WEBENCH® Filter Designer* to implement second-order low-pass Butterworth filter circuits. 图 9-17 shows the frequency response.

Other MFB and Sallen-Key filter circuits display similar performance. The main difference is the MFB is an inverting amplifier in the pass band and the Sallen-Key is noninverting. The primary advantage for each is the Sallen-Key in unity gain has no resistor gain error term, and thus no sensitivity to gain error, while the MFB has better attenuation properties beyond the bandwidth of the op amp.

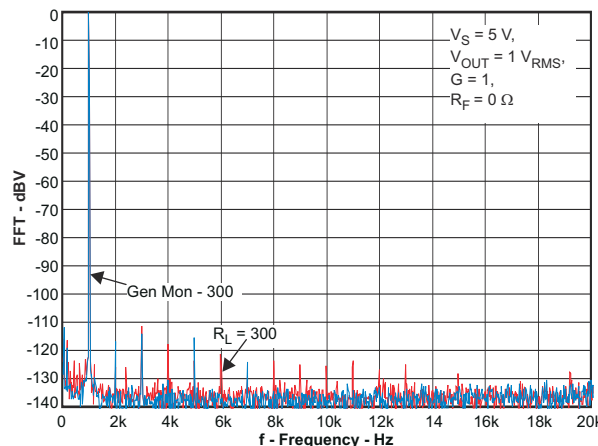

图 9-15. MFB 100-kHz Second-Order Low-Pass Butterworth Filter Circuit



图 9-16. Sallen-Key 100-kHz Second-Order Low-Pass Butterworth Filter Circuit

#### 9.2.2.1 Application Curve

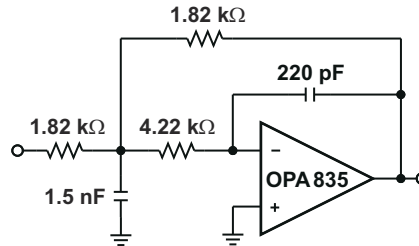

图 9-17. MFB and Sallen-Key Second-Order Low-Pass Butterworth Filter Response

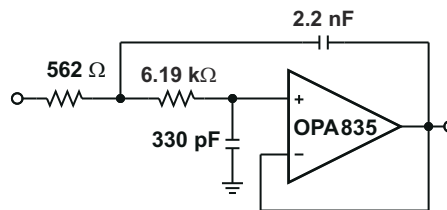
## 10 Power Supply Recommendations

The OPAx835 devices are intended to work in a supply range of 2.7 V to 5 V. Supply-voltage tolerances are supported with the specified operating range of 2.5 V (7% on a 2.7-V supply) and 5.5 V (10% on a 5-V supply). Good power-supply bypassing is required. Minimize the distance (< 0.1 inch) from the power-supply pins to high frequency, 0.1- $\mu$ F decoupling capacitors. A larger capacitor (2.2  $\mu$ F is typical) is used along with a high frequency, 0.1- $\mu$ F supply-decoupling capacitor at the device supply pins. For single-supply operation, only the positive supply has these capacitors. When a split supply is used, use these capacitors for each supply to ground. If necessary, place the larger capacitors further from the device and share these capacitors among several devices in the same area of the PCB. Avoid narrow power and ground traces to minimize inductance between the pins and the decoupling capacitors. An optional supply decoupling capacitor across the two power supplies (for bipolar operation) reduces second harmonic distortion.

## 11 Layout

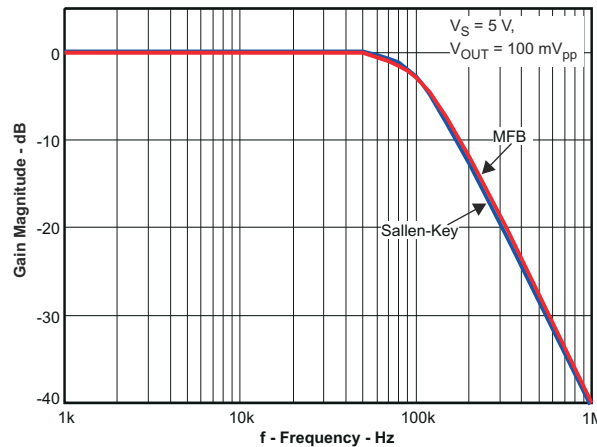
### 11.1 Layout Guidelines

The [OPA835 EVM](#) (SLOU314) can be used as a reference when designing the circuit board. TI recommends following the EVM layout of the external components near to the amplifier, ground plane construction, and power routing as closely as possible. General guidelines are listed below:

1. Signal routing must be direct and as short as possible into an out of the op amp.
2. The feedback path must be short and direct avoiding vias if possible, especially with  $G = +1$ .
3. Ground or power planes must be removed from directly under the negative input and output pins of the amplifier.
4. TI recommends placing a series output resistor as close to the output pin as possible. See [Series Output Resistor vs Capacitive Load](#) for recommended values for the expected capacitive load.
5. A 2.2- $\mu$ F power-supply decoupling capacitor must be placed within two inches of the device and can be shared with other op amps. For split supply, a capacitor is required for both supplies.
6. A 0.1- $\mu$ F power-supply decoupling capacitor must be placed as close to the supply pins as possible, preferably within 0.1 inch. For split supply, a capacitor is required for both supplies.
7. The  $\overline{PD}$  pin uses TTL logic levels. If the pin is not used, it must tied to the positive supply to enable the amplifier. If the pin is used, it must be actively driven. A bypass capacitor is not necessary, but is used for robustness in noisy environments.

## 11.2 Layout Example

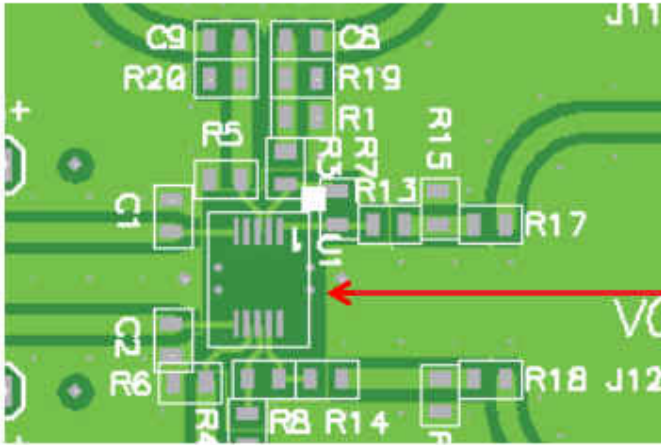

Dark green areas indicate regions of the PCB where the underlying Ground and Power Planes have been removed in order to minimize parasitic capacitance on the sensitive input and output nodes.

图 11-1. Top Layer

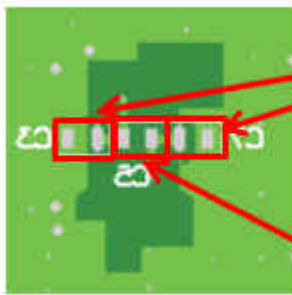

C3 and C7 are 0.1- $\mu$ F bypass capacitors placed directly underneath the device power supply pins.

C5 is a bypass capacitor between the supply pins. Use this when configuring the amplifier with bipolar supplies to improve HD2 performance.

图 11-2. Bottom Layer

## 12 Device and Documentation Support

### 12.1 Device Support

#### 12.1.1 Development Support

[WEBENCH® Filter Designer](#)

### 12.2 Documentation Support

#### 12.2.1 Related Documentation

For related documentation see the following:

- Texas Instruments, [OPA835DBV](#), [OPA836DBV EVM user's guide](#)

### 12.3 Related Links

表 12-1 lists quick access links. Categories include technical documents, support and community resources, tools and software, and quick access to sample or buy.

表 12-1. Related Links

PARTS	PRODUCT FOLDER	SAMPLE & BUY	TECHNICAL DOCUMENTS	TOOLS & SOFTWARE	SUPPORT & COMMUNITY
OPA835	<a href="#">Click here</a>	<a href="#">Click here</a>	<a href="#">Click here</a>	<a href="#">Click here</a>	<a href="#">Click here</a>
OPA2835	<a href="#">Click here</a>	<a href="#">Click here</a>	<a href="#">Click here</a>	<a href="#">Click here</a>	<a href="#">Click here</a>

### 12.4 Receiving Notification of Documentation Updates

To receive notification of documentation updates, navigate to the device product folder on ti.com. In the upper right corner, click on *Alert me* to register and receive a weekly digest of any product information that has changed. For change details, review the revision history included in any revised document.

### 12.5 支持资源

TI E2E™ 支持论坛是工程师的重要参考资料，可直接从专家获得快速、经过验证的解答和设计帮助。搜索现有解答或提出自己的问题可获得所需的快速设计帮助。

链接的内容由各个贡献者“按原样”提供。这些内容并不构成 TI 技术规范，并且不一定反映 TI 的观点；请参阅 TI 的《使用条款》。

### 12.6 Trademarks

TI E2E™ is a trademark of Texas Instruments.

WEBENCH® is a registered trademark of TI.

所有商标均为其各自所有者的财产。

### 12.7 静电放电警告



静电放电 (ESD) 会损坏这个集成电路。德州仪器 (TI) 建议通过适当的预防措施处理所有集成电路。如果不遵守正确的处理和安装程序，可能会损坏集成电路。

ESD 的损坏小至导致微小的性能降级，大至整个器件故障。精密的集成电路可能更容易受到损坏，这是因为非常细微的参数更改都可能会导致器件与其发布的规格不相符。

### 12.8 术语表

TI 术语表 本术语表列出并解释了术语、首字母缩略词和定义。

## 13 Mechanical, Packaging, and Orderable Information

The following pages include mechanical, packaging, and orderable information. This information is the most current data available for the designated devices. This data is subject to change without notice and revision of this document. For browser-based versions of this data sheet, refer to the left-hand navigation.

**PACKAGING INFORMATION**

Orderable Device	Status (1)	Package Type	Package Drawing	Pins	Package Qty	Eco Plan (2)	Lead finish/ Ball material (6)	MSL Peak Temp (3)	Op Temp (°C)	Device Marking (4/5)	Samples
OPA2835ID	ACTIVE	SOIC	D	8	75	RoHS & Green	NIPDAU	Level-2-260C-1 YEAR	-40 to 125	2835	<a href="#">Samples</a>
OPA2835IDGS	ACTIVE	VSSOP	DGS	10	80	RoHS & Green	NIPDAUAG	Level-2-260C-1 YEAR	-40 to 125	2835	<a href="#">Samples</a>
OPA2835IDGSR	ACTIVE	VSSOP	DGS	10	2500	RoHS & Green	NIPDAUAG	Level-2-260C-1 YEAR	-40 to 125	2835	<a href="#">Samples</a>
OPA2835IDR	ACTIVE	SOIC	D	8	2500	RoHS & Green	NIPDAU	Level-2-260C-1 YEAR	-40 to 125	2835	<a href="#">Samples</a>
OPA2835IRMCR	ACTIVE	UQFN	RMC	10	3000	RoHS & Green	NIPDAU	Level-2-260C-1 YEAR	-40 to 125	2835	<a href="#">Samples</a>
OPA2835IRMCT	ACTIVE	UQFN	RMC	10	250	RoHS & Green	NIPDAU	Level-2-260C-1 YEAR	-40 to 125	2835	<a href="#">Samples</a>
OPA2835IRUNR	ACTIVE	QFN	RUN	10	3000	RoHS & Green	NIPDAU	Level-2-260C-1 YEAR	-40 to 125	2835	<a href="#">Samples</a>
OPA2835IRUNT	ACTIVE	QFN	RUN	10	250	RoHS & Green	NIPDAU	Level-2-260C-1 YEAR	-40 to 125	2835	<a href="#">Samples</a>
OPA835IDBVR	ACTIVE	SOT-23	DBV	6	3000	RoHS & Green	SN	Level-1-260C-UNLIM	-40 to 125	QUM	<a href="#">Samples</a>
OPA835IDBVT	ACTIVE	SOT-23	DBV	6	250	RoHS & Green	SN	Level-1-260C-UNLIM	-40 to 125	QUM	<a href="#">Samples</a>
OPA835IRUNR	ACTIVE	QFN	RUN	10	3000	RoHS & Green	NIPDAU	Level-2-260C-1 YEAR	-40 to 125	835	<a href="#">Samples</a>
OPA835IRUNT	ACTIVE	QFN	RUN	10	250	RoHS & Green	NIPDAU	Level-2-260C-1 YEAR	-40 to 125	835	<a href="#">Samples</a>

(1) The marketing status values are defined as follows:

**ACTIVE:** Product device recommended for new designs.

**LIFEBUY:** TI has announced that the device will be discontinued, and a lifetime-buy period is in effect.

**NRND:** Not recommended for new designs. Device is in production to support existing customers, but TI does not recommend using this part in a new design.

**PREVIEW:** Device has been announced but is not in production. Samples may or may not be available.

**OBSOLETE:** TI has discontinued the production of the device.

(2) **RoHS:** TI defines "RoHS" to mean semiconductor products that are compliant with the current EU RoHS requirements for all 10 RoHS substances, including the requirement that RoHS substance do not exceed 0.1% by weight in homogeneous materials. Where designed to be soldered at high temperatures, "RoHS" products are suitable for use in specified lead-free processes. TI may reference these types of products as "Pb-Free".

**RoHS Exempt:** TI defines "RoHS Exempt" to mean products that contain lead but are compliant with EU RoHS pursuant to a specific EU RoHS exemption.

**Green:** TI defines "Green" to mean the content of Chlorine (Cl) and Bromine (Br) based flame retardants meet JS709B low halogen requirements of <=1000ppm threshold. Antimony trioxide based flame retardants must also meet the <=1000ppm threshold requirement.

- (3) MSL, Peak Temp. - The Moisture Sensitivity Level rating according to the JEDEC industry standard classifications, and peak solder temperature.
- (4) There may be additional marking, which relates to the logo, the lot trace code information, or the environmental category on the device.
- (5) Multiple Device Markings will be inside parentheses. Only one Device Marking contained in parentheses and separated by a "~" will appear on a device. If a line is indented then it is a continuation of the previous line and the two combined represent the entire Device Marking for that device.
- (6) Lead finish/Ball material - Orderable Devices may have multiple material finish options. Finish options are separated by a vertical ruled line. Lead finish/Ball material values may wrap to two lines if the finish value exceeds the maximum column width.

**Important Information and Disclaimer:**The information provided on this page represents TI's knowledge and belief as of the date that it is provided. TI bases its knowledge and belief on information provided by third parties, and makes no representation or warranty as to the accuracy of such information. Efforts are underway to better integrate information from third parties. TI has taken and continues to take reasonable steps to provide representative and accurate information but may not have conducted destructive testing or chemical analysis on incoming materials and chemicals. TI and TI suppliers consider certain information to be proprietary, and thus CAS numbers and other limited information may not be available for release.

In no event shall TI's liability arising out of such information exceed the total purchase price of the TI part(s) at issue in this document sold by TI to Customer on an annual basis.

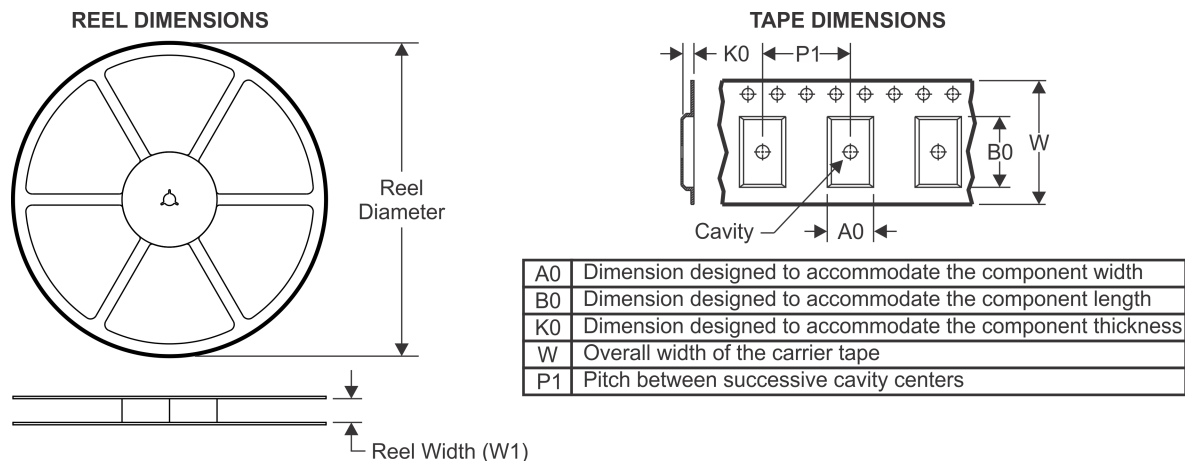
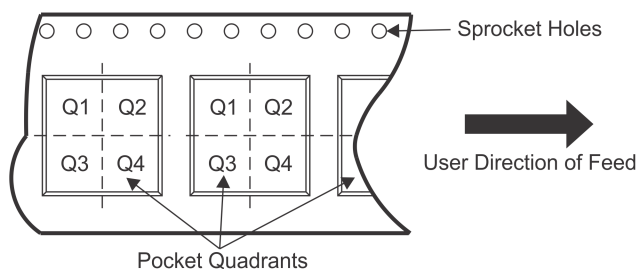
**TAPE AND REEL INFORMATION**

**QUADRANT ASSIGNMENTS FOR PIN 1 ORIENTATION IN TAPE**

\*All dimensions are nominal

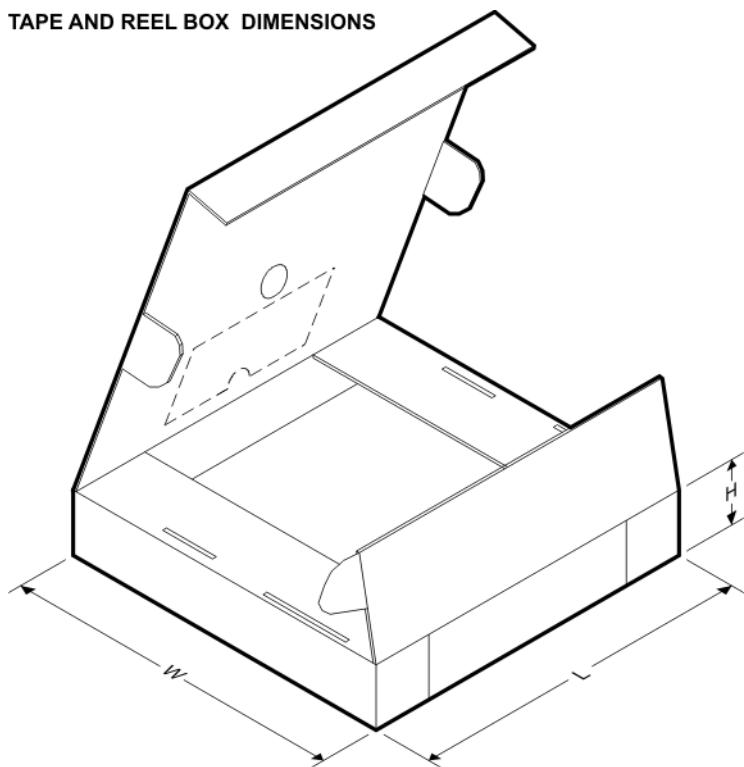
Device	Package Type	Package Drawing	Pins	SPQ	Reel Diameter (mm)	Reel Width W1 (mm)	A0 (mm)	B0 (mm)	K0 (mm)	P1 (mm)	W (mm)	Pin1 Quadrant
OPA2835IDGSR	VSSOP	DGS	10	2500	330.0	12.4	5.3	3.4	1.4	8.0	12.0	Q1
OPA2835IDR	SOIC	D	8	2500	330.0	12.4	6.4	5.2	2.1	8.0	12.0	Q1
OPA2835IRMCR	UQFN	RMC	10	3000	180.0	9.5	2.3	2.3	1.1	2.0	8.0	Q2
OPA2835IRMCT	UQFN	RMC	10	250	180.0	9.5	2.3	2.3	1.1	2.0	8.0	Q2
OPA2835IRUNR	QFN	RUN	10	3000	180.0	8.4	2.3	2.3	1.15	4.0	8.0	Q2
OPA2835IRUNT	QFN	RUN	10	250	180.0	8.4	2.3	2.3	1.15	4.0	8.0	Q2
OPA835IDBVR	SOT-23	DBV	6	3000	178.0	9.0	3.23	3.17	1.37	4.0	8.0	Q3
OPA835IDBVT	SOT-23	DBV	6	250	178.0	9.0	3.23	3.17	1.37	4.0	8.0	Q3
OPA835IRUNR	QFN	RUN	10	3000	180.0	8.4	2.3	2.3	1.15	4.0	8.0	Q2
OPA835IRUNT	QFN	RUN	10	250	180.0	8.4	2.3	2.3	1.15	4.0	8.0	Q2

**TAPE AND REEL BOX DIMENSIONS**

\*All dimensions are nominal

Device	Package Type	Package Drawing	Pins	SPQ	Length (mm)	Width (mm)	Height (mm)
OPA2835IDGSR	VSSOP	DGS	10	2500	366.0	364.0	50.0
OPA2835IDR	SOIC	D	8	2500	340.5	336.1	25.0
OPA2835IRMCR	UQFN	RMC	10	3000	205.0	200.0	30.0
OPA2835IRMCT	UQFN	RMC	10	250	205.0	200.0	30.0
OPA2835IRUNR	QFN	RUN	10	3000	210.0	185.0	35.0
OPA2835IRUNT	QFN	RUN	10	250	210.0	185.0	35.0
OPA835IDBVR	SOT-23	DBV	6	3000	180.0	180.0	18.0
OPA835IDBVT	SOT-23	DBV	6	250	180.0	180.0	18.0
OPA835IRUNR	QFN	RUN	10	3000	210.0	185.0	35.0
OPA835IRUNT	QFN	RUN	10	250	210.0	185.0	35.0

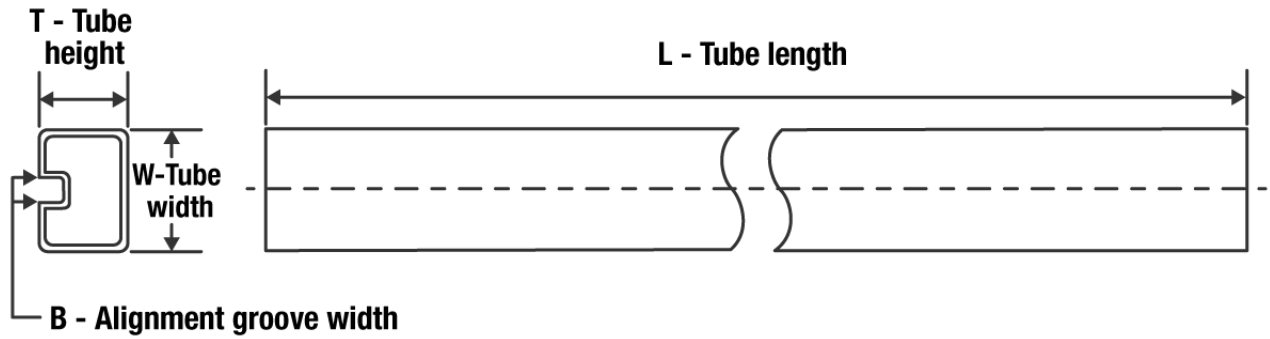
**TUBE**

\*All dimensions are nominal

Device	Package Name	Package Type	Pins	SPQ	L (mm)	W (mm)	T (μm)	B (mm)
OPA2835ID	D	SOIC	8	75	507	8	3940	4.32
OPA2835IDGS	DGS	VSSOP	10	80	330	6.55	500	2.88



RMC (S-PUQFN-N10)

PLASTIC QUAD FLATPACK NO-LEAD

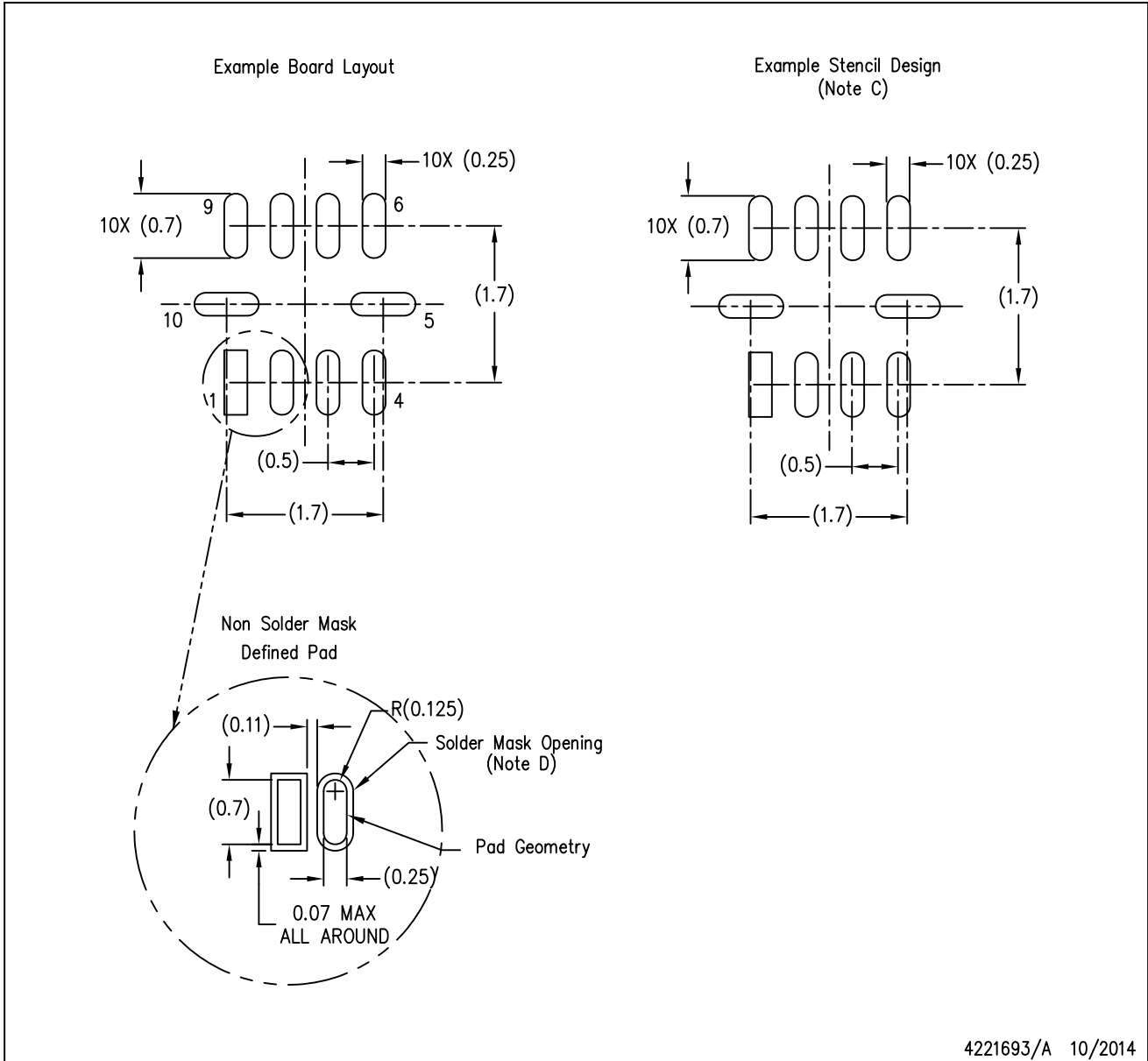

- NOTES:
- A. All linear dimensions are in millimeters. Dimensions in parenthesis are for reference only.
  - B. This drawing is subject to change without notice.
  - C. Laser cutting apertures with trapezoidal walls and also rounding corners will offer better paste release. Customers should contact their board assembly site for stencil design recommendations. Refer to IPC 7525 for stencil design considerations.
  - D. Customers should contact their board fabrication site for minimum solder mask web tolerances between signal pads.

# DGS0010A

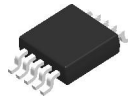

# PACKAGE OUTLINE

## VSSOP - 1.1 mm max height

SMALL OUTLINE PACKAGE



4221984/A 05/2015

### NOTES:

1. All linear dimensions are in millimeters. Any dimensions in parenthesis are for reference only. Dimensioning and tolerancing per ASME Y14.5M.
2. This drawing is subject to change without notice.
3. This dimension does not include mold flash, protrusions, or gate burrs. Mold flash, protrusions, or gate burrs shall not exceed 0.15 mm per side.
4. This dimension does not include interlead flash. Interlead flash shall not exceed 0.25 mm per side.
5. Reference JEDEC registration MO-187, variation BA.

# EXAMPLE BOARD LAYOUT

DGS0010A

VSSOP - 1.1 mm max height

SMALL OUTLINE PACKAGE



LAND PATTERN EXAMPLE  
SCALE:10X

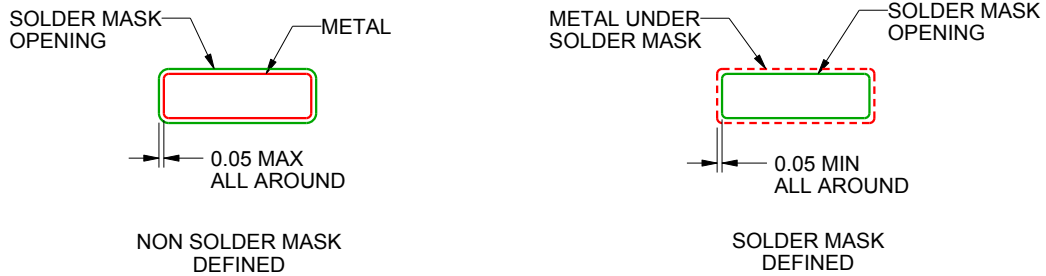

SOLDER MASK DETAILS  
NOT TO SCALE

4221984/A 05/2015

NOTES: (continued)

- 6. Publication IPC-7351 may have alternate designs.
- 7. Solder mask tolerances between and around signal pads can vary based on board fabrication site.

# EXAMPLE STENCIL DESIGN

DGS0010A

VSSOP - 1.1 mm max height

SMALL OUTLINE PACKAGE



SOLDER PASTE EXAMPLE  
BASED ON 0.125 mm THICK STENCIL  
SCALE:10X

4221984/A 05/2015

NOTES: (continued)

8. Laser cutting apertures with trapezoidal walls and rounded corners may offer better paste release. IPC-7525 may have alternate design recommendations.
9. Board assembly site may have different recommendations for stencil design.

## GENERIC PACKAGE VIEW

**RUN 10**

**WQFN - 0.8 mm max height**

2 X 2, 0.5 mm pitch

PLASTIC QUAD FLATPACK - NO LEAD

This image is a representation of the package family, actual package may vary.  
Refer to the product data sheet for package details.

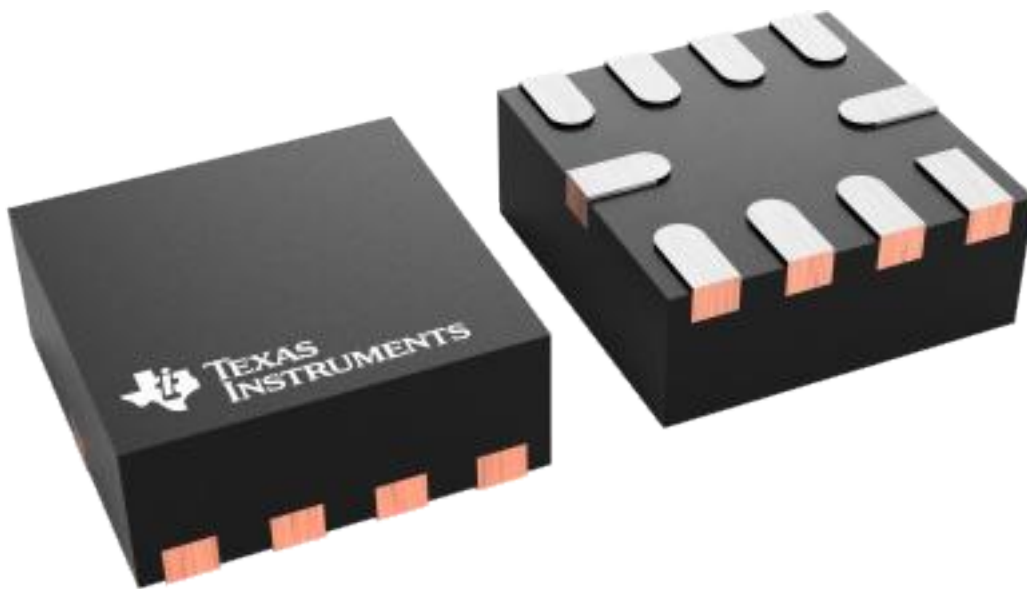

4228249/A

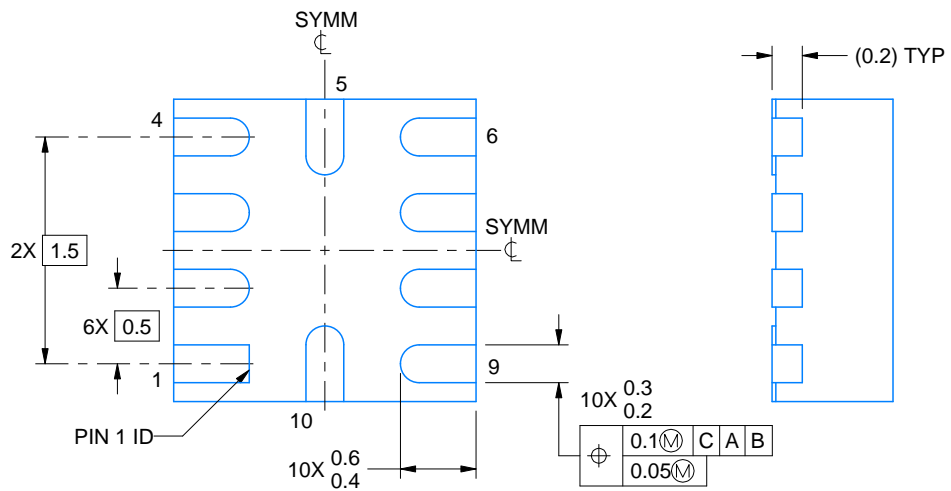
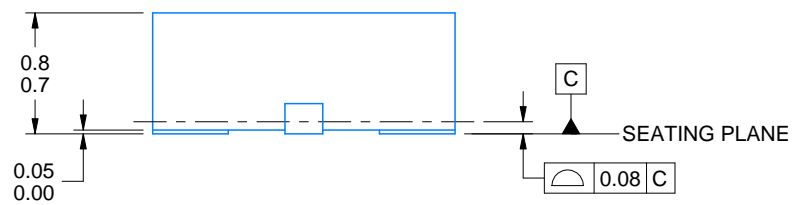
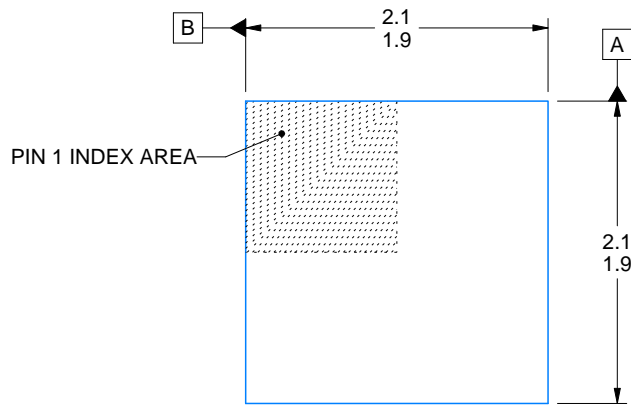
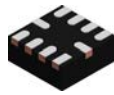

4220470/A 05/2020

NOTES:

1. All linear dimensions are in millimeters. Any dimensions in parenthesis are for reference only. Dimensioning and tolerancing per ASME Y14.5M.
2. This drawing is subject to change without notice.

# EXAMPLE BOARD LAYOUT

RUN0010A

WQFN - 0.8 mm max height

PLASTIC QUAD FLATPACK - NO LEAD

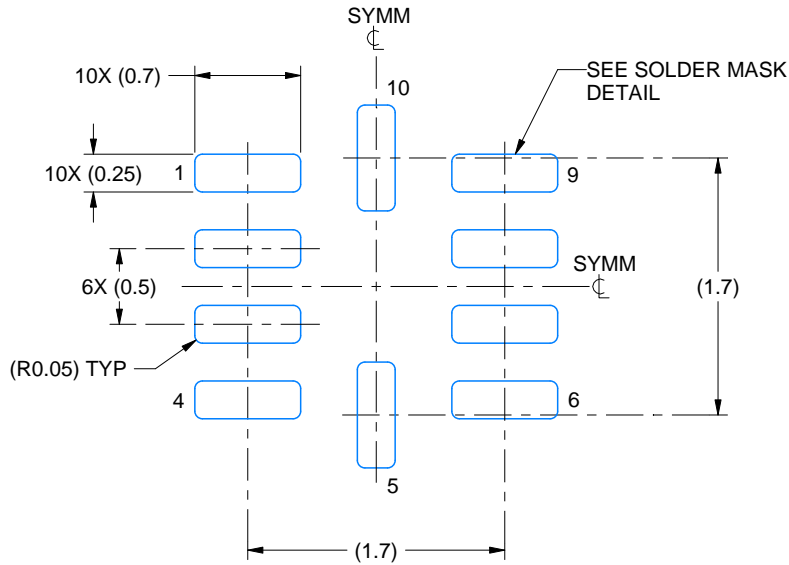

LAND PATTERN EXAMPLE  
EXPOSED METAL SHOWN  
SCALE: 20X

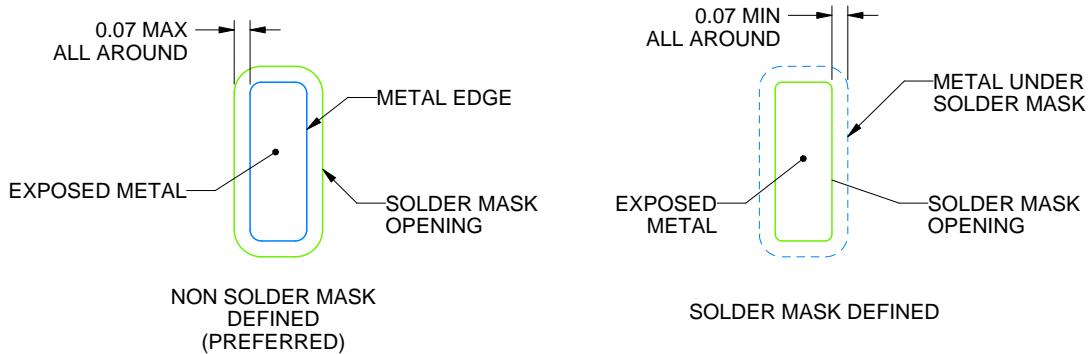

SOLDER MASK DETAILS

4220470/A 05/2020

NOTES: (continued)

- This package is designed to be soldered to a thermal pad on the board. For more information, see Texas Instruments literature number SLUA271 ([www.ti.com/lit/slua271](http://www.ti.com/lit/slua271)).

# EXAMPLE STENCIL DESIGN

RUN0010A

WQFN - 0.8 mm max height

PLASTIC QUAD FLATPACK - NO LEAD

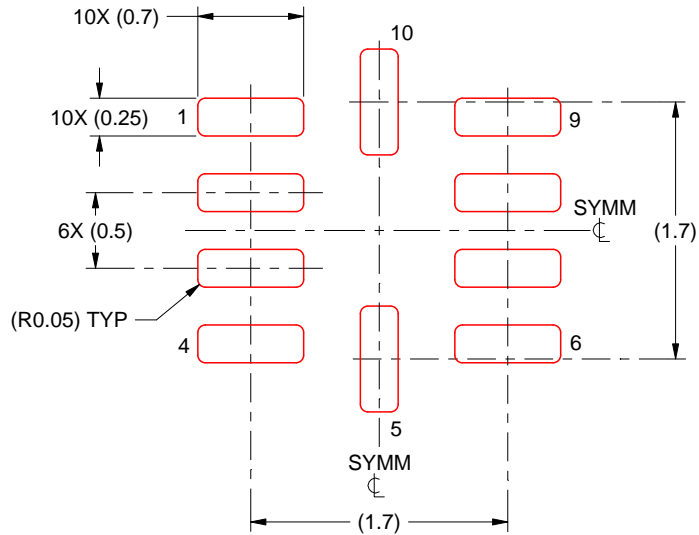

SOLDER PASTE EXAMPLE  
BASED ON 0.125 MM THICK STENCIL  
SCALE: 20X

4220470/A 05/2020

NOTES: (continued)

4. Laser cutting apertures with trapezoidal walls and rounded corners may offer better paste release. IPC-7525 may have alternate design recommendations.



# EXAMPLE BOARD LAYOUT

D0008A

SOIC - 1.75 mm max height

SMALL OUTLINE INTEGRATED CIRCUIT



LAND PATTERN EXAMPLE  
EXPOSED METAL SHOWN  
SCALE:8X



SOLDER MASK DETAILS

4214825/C 02/2019

NOTES: (continued)

- 6. Publication IPC-7351 may have alternate designs.
- 7. Solder mask tolerances between and around signal pads can vary based on board fabrication site.

# EXAMPLE STENCIL DESIGN

D0008A

SOIC - 1.75 mm max height

SMALL OUTLINE INTEGRATED CIRCUIT

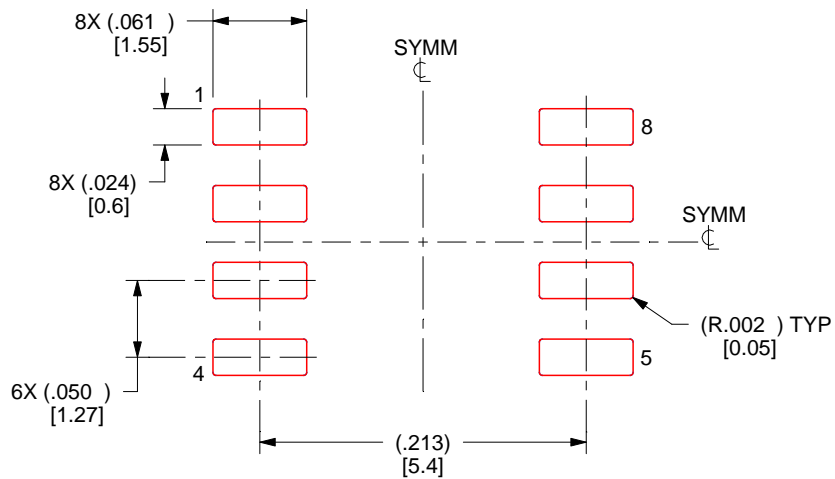

SOLDER PASTE EXAMPLE  
BASED ON .005 INCH [0.125 MM] THICK STENCIL  
SCALE:8X

4214825/C 02/2019

NOTES: (continued)

8. Laser cutting apertures with trapezoidal walls and rounded corners may offer better paste release. IPC-7525 may have alternate design recommendations.
9. Board assembly site may have different recommendations for stencil design.



# EXAMPLE BOARD LAYOUT

DBV0006A

SOT-23 - 1.45 mm max height

SMALL OUTLINE TRANSISTOR

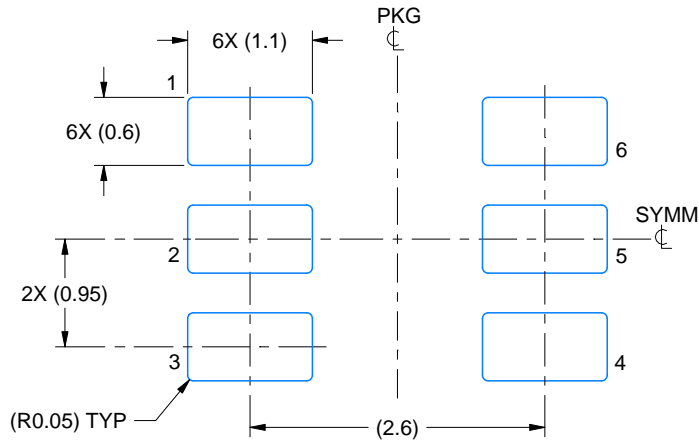

LAND PATTERN EXAMPLE  
EXPOSED METAL SHOWN  
SCALE:15X

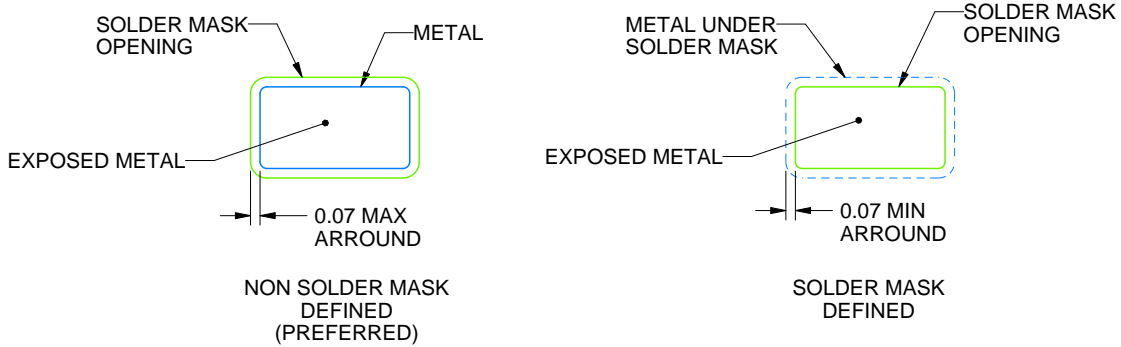

SOLDER MASK DETAILS

4214840/C 06/2021

NOTES: (continued)

- 6. Publication IPC-7351 may have alternate designs.
- 7. Solder mask tolerances between and around signal pads can vary based on board fabrication site.

# EXAMPLE STENCIL DESIGN

DBV0006A

SOT-23 - 1.45 mm max height

SMALL OUTLINE TRANSISTOR

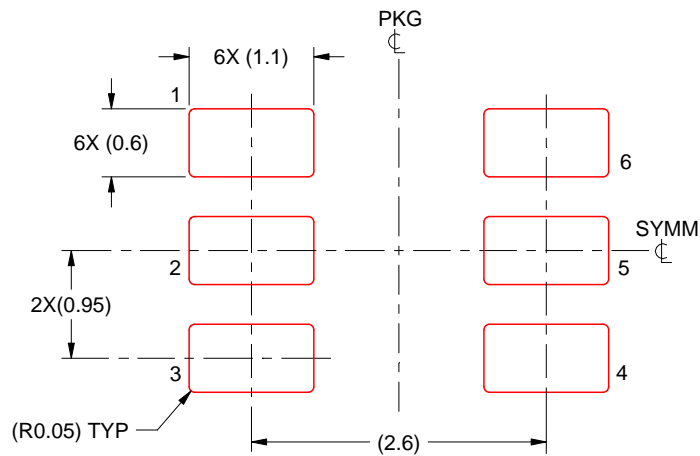

SOLDER PASTE EXAMPLE  
BASED ON 0.125 mm THICK STENCIL  
SCALE:15X

4214840/C 06/2021

NOTES: (continued)

8. Laser cutting apertures with trapezoidal walls and rounded corners may offer better paste release. IPC-7525 may have alternate design recommendations.
9. Board assembly site may have different recommendations for stencil design.

## 重要声明和免责声明

TI“按原样”提供技术和可靠性数据（包括数据表）、设计资源（包括参考设计）、应用或其他设计建议、网络工具、安全信息和其他资源，不保证没有瑕疵且不做任何明示或暗示的担保，包括但不限于对适销性、某特定用途方面的适用性或不侵犯任何第三方知识产权的暗示担保。

这些资源可供使用 TI 产品进行设计的熟练开发人员使用。您将自行承担以下全部责任：(1) 针对您的应用选择合适的 TI 产品，(2) 设计、验证并测试您的应用，(3) 确保您的应用满足相应标准以及任何其他功能安全、信息安全、监管或其他要求。

这些资源如有变更，恕不另行通知。TI 授权您仅可将这些资源用于研发本资源所述的 TI 产品的应用。严禁对这些资源进行其他复制或展示。您无权使用任何其他 TI 知识产权或任何第三方知识产权。您应全额赔偿因在这些资源的使用中对 TI 及其代表造成的任何索赔、损害、成本、损失和债务，TI 对此概不负责。

TI 提供的产品受 [TI 的销售条款](#) 或 [ti.com](#) 上其他适用条款/TI 产品随附的其他适用条款的约束。TI 提供这些资源并不会扩展或以其他方式更改 TI 针对 TI 产品发布的适用的担保或担保免责声明。

TI 反对并拒绝您可能提出的任何其他或不同的条款。

邮寄地址：Texas Instruments, Post Office Box 655303, Dallas, Texas 75265

Copyright © 2022，德州仪器 (TI) 公司