

SN74AHCT1G86 Single 2-Input Exclusive-OR Gate

1 Features

- Operating Range of 4.5 V to 5.5 V
- Max t_{pd} of 8 ns at 5 V
- Low Power Consumption, 10-A Maximum I_{CC}
- 8-mA Output Drive at 5 V
- Inputs Are TTL-Voltage Compatible
- Latch-Up Performance Exceeds 250 mA Per JESD 17
- ESD Protection Exceeds JESD 22
 - 2000-V Human Body Model (A114-A)
 - 1000-V Charged-Device Model (C101)

2 Applications

- Industrial PCs
- Stepper Motors
- AC Inverter Drives
- Notebook PCs
- Smart Meters: Data Concentrators
- Enterprise Servers

3 Description

The SN74AHCT1G86 is a single 2-input exclusive-OR gate. The device performs the Boolean function $Y = A \oplus B$ or $Y = \bar{A}B + A\bar{B}$ in positive logic.

Device Information⁽¹⁾

| PART NUMBER | PACKAGE | BODY SIZE (NOM) |
|--------------|------------|-------------------|
| SN74AHCT1G86 | SOT-23 (5) | 2.90 mm x 1.60 mm |
| | | 2.00 mm x 1.25 mm |

(1) For all available packages, see the orderable addendum at the end of the datasheet.

Exclusive-OR Logic

An exclusive-OR gate has many applications, some of which can be represented better by alternative logic symbols.

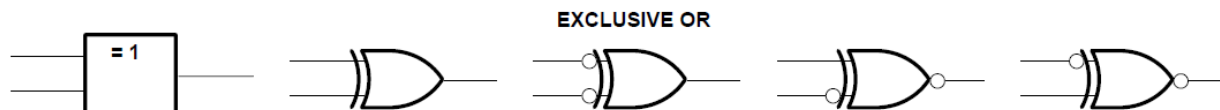

These five equivalent exclusive-OR symbols are valid for an SN74AHCT1G86 gate in positive logic; negation may be shown at any two ports.

LOGIC-IDENTITY ELEMENT

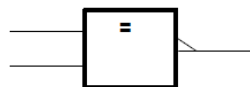

The output is active (low) if all inputs stand at the same logic level (i.e., $A = B$).

EVEN-PARITY ELEMENT

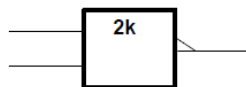

The output is active (low) if an even number of inputs (i.e., 0 or 2) are active.

ODD-PARITY ELEMENT

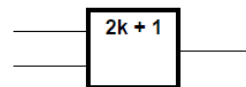

The output is active (high) if an odd number of inputs (i.e., only 1 of the 2) are active.



Table of Contents

| | | | |
|--|----------|--|-----------|
| 1 Features | 1 | 8.1 Overview | 7 |
| 2 Applications | 1 | 8.2 Functional Block Diagram | 7 |
| 3 Description | 1 | 8.3 Feature Description | 7 |
| 4 Revision History | 2 | 8.4 Device Functional Modes | 7 |
| 5 Pin Configuration and Functions | 3 | 9 Application and Implementation | 8 |
| 6 Specifications | 3 | 9.1 Application Information | 8 |
| 6.1 Absolute Maximum Ratings | 3 | 9.2 Typical Application | 8 |
| 6.2 ESD Ratings | 3 | 10 Power Supply Recommendations | 10 |
| 6.3 Recommended Operating Conditions | 4 | 11 Layout | 10 |
| 6.4 Thermal Information | 4 | 11.1 Layout Guidelines | 10 |
| 6.5 Electrical Characteristics | 4 | 11.2 Layout Example | 10 |
| 6.6 Switching Characteristics | 5 | 12 Device and Documentation Support | 11 |
| 6.7 Operating Characteristics | 5 | 12.1 Trademarks | 11 |
| 6.8 Typical Characteristics | 5 | 12.2 Electrostatic Discharge Caution | 11 |
| 7 Parameter Measurement Information | 6 | 12.3 Glossary | 11 |
| 8 Detailed Description | 7 | 13 Mechanical, Packaging, and Orderable Information | 11 |

4 Revision History

Changes from Revision L (January 2003) to Revision M

Page

- Added *Pin Configuration and Functions* section, *ESD Ratings* table, *Feature Description* section, *Device Functional Modes*, *Application and Implementation* section, *Power Supply Recommendations* section, *Layout* section, *Device and Documentation Support* section, and *Mechanical, Packaging, and Orderable Information* section **1**

5 Pin Configuration and Functions

DBV or DCK Package
5-Pin SOT-23
Top View

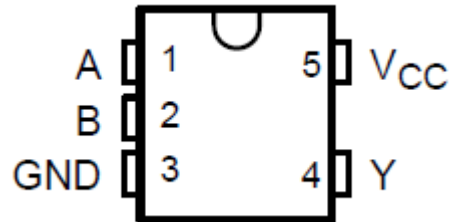

Pin Functions

| PIN | | I/O | DESCRIPTION |
|-----|-----------------|-----|-------------|
| NO. | NAME | | |
| 1 | A | I | A input |
| 2 | B | I | B input |
| 3 | GND | – | Ground pin |
| 4 | Y | O | Output |
| 5 | V _{CC} | – | Power pin |

6 Specifications

6.1 Absolute Maximum Ratings

over operating free-air temperature range (unless otherwise noted) ⁽¹⁾

| | | MIN | MAX | UNIT |
|------------------|---|------|-----------------------|------|
| V _{CC} | Supply voltage | –0.5 | 7 | V |
| V _I | Input voltage ⁽²⁾ | –0.5 | 7 | V |
| V _O | Output voltage ⁽²⁾ | –0.5 | V _{CC} + 0.5 | V |
| I _{IK} | Input clamp current | | –20 | mA |
| I _{OK} | Output clamp current | | 20 | mA |
| I _O | Continuous output current | | 25 | mA |
| | Continuous current through V _{CC} or GND | –50 | 50 | mA |
| T _{stg} | Storage temperature | –65 | 150 | °C |

- (1) Stresses beyond those listed under *Absolute Maximum Ratings* may cause permanent damage to the device. These are stress ratings only, which do not imply functional operation of the device at these or any other conditions beyond those indicated under *Recommended Operating Conditions*. Exposure to absolute-maximum-rated conditions for extended periods may affect device reliability.
- (2) The input and output voltage ratings may be exceeded if the input and output current ratings are observed.

6.2 ESD Ratings

| | | VALUE | UNIT |
|--------------------|-------------------------|--|------|
| V _(ESD) | Electrostatic discharge | | V |
| | | Human body model (HBM), per ANSI/ESDA/JEDEC JS-001 ⁽¹⁾ | |
| | | Charged-device model (CDM), per JEDEC specification JESD22-C101 ⁽²⁾ | 1000 |

- (1) JEDEC document JEP155 states that 500-V HBM allows safe manufacturing with a standard ESD control process.
- (2) JEDEC document JEP157 states that 250-V CDM allows safe manufacturing with a standard ESD control process.

6.3 Recommended Operating Conditions

over operating free-air temperature range (unless otherwise noted)

| | | MIN | NOM | MAX | UNIT |
|----------|------------------------------------|-----|-----|----------|------|
| V_{CC} | Supply voltage | 4.5 | | 5.5 | V |
| V_{IH} | High-level input voltage | 2 | | | V |
| V_{IL} | Low-level input voltage | | | 0.8 | V |
| V_I | Input voltage | 0 | | 5.5 | V |
| V_O | Output voltage | 0 | | V_{CC} | V |
| I_{OH} | High-level output current | | | -8 | mA |
| I_{OL} | Low-level output current | | | 8 | mA |
| t/v | Input transition rise or fall rate | | | 20 | ns/V |
| T_A | Operating free-air temperature | -40 | | 125 | °C |

6.4 Thermal Information

| THERMAL METRIC ⁽¹⁾ | | SN74AHCT1G86 | | UNIT |
|-------------------------------|--|--------------|-------------|------|
| | | DBV (SOT-23) | DCK (SC-70) | |
| | | 5 PINS | 5 PINS | |
| $R_{\theta JA}$ | Junction-to-ambient thermal resistance | 208.2 | 287.6 | °C/W |
| $R_{\theta JC(top)}$ | Junction-to-case (top) thermal resistance | 76.1 | 97.7 | |
| $R_{\theta JB}$ | Junction-to-board thermal resistance | 52.5 | 65 | |
| Ψ_{JT} | Junction-to-top characterization parameter | 4 | 2 | |
| Ψ_{JB} | Junction-to-board characterization parameter | 51.8 | 64.2 | |

 (1) For more information about traditional and new thermal metrics, see the *IC Package Thermal Metrics* application report ([SPRA953](#)).

6.5 Electrical Characteristics

over operating free-air temperature range (unless otherwise noted)

| PARAMETER | TEST CONDITIONS | V_{CC} | $T_A = 25^\circ\text{C}$ | | | $-40^\circ\text{C to } 85^\circ\text{C}$ | | $-40^\circ\text{C to } 125^\circ\text{C}$ | | UNIT |
|-----------------------|---|--------------|--------------------------|-----|-----------|--|---------|---|---------------|------|
| | | | MIN | TYP | MAX | MIN | MAX | MIN | MAX | |
| V_{OH} | $I_{OH} = -50 \mu\text{A}$ | 4.5 V | 4.4 | 4.5 | | 4.4 | | 4.4 | V | |
| | $I_{OH} = -8 \text{ mA}$ | | | | | 3.8 | | 3.8 | | |
| V_{OL} | $I_{OL} = 50 \mu\text{A}$ | 4.5 V | | | 0.1 | | 0.1 | 0.1 | V | |
| | $I_{OL} = 8 \text{ mA}$ | | | | 0.36 | | 0.44 | 0.44 | | |
| I_I | $V_I = 5.5 \text{ V or GND}$ | 0 V to 5.5 V | | | ± 0.1 | | ± 1 | ± 1 | μA | |
| I_{CC} | $V_I = V_{CC} \text{ or GND, } I_O = 0$ | 5.5 V | | | 1 | | 10 | 10 | μA | |
| $\Delta I_{CC}^{(1)}$ | One input at 3.4 V, Other inputs at V_{CC} or GND | 5.5 V | | | 1.35 | | 1.5 | 1.5 | mA | |
| C_i | $V_I = V_{CC} \text{ or GND}$ | 5 V | | 2 | 10 | | 10 | 10 | pF | |

 (1) This is the increase in supply current for each input at one of the specified TTL voltage levels, rather than 0 V or V_{CC} .

6.6 Switching Characteristics

over recommended operating free-air temperature range, $V_{CC} = 5 V \pm 0.5 V$ (unless otherwise noted) (see)

| PARAMETER | FROM (INPUT) | TO (OUTPUT) | LOAD CAPACITANCE | $T_A = 25^\circ C$ | | $-40^\circ C$ to $85^\circ C$ | | $-40^\circ C$ to $125^\circ C$ | | UNIT |
|-----------|--------------|-------------|-----------------------|--------------------|-----|-------------------------------|-----|--------------------------------|-----|------|
| | | | | TYP | MAX | MIN | MAX | MIN | MAX | |
| t_{PLH} | A or B | Y | $C_L = 15 \text{ pF}$ | 5 | 6.2 | 1 | 8 | 1 | 9 | ns |
| t_{PHL} | | | | 5 | 6.2 | 1 | 8 | 1 | 9 | |
| t_{PLH} | A or B | Y | $C_L = 50 \text{ pF}$ | 5.5 | 7.9 | 1 | 9 | 1 | 10 | ns |
| t_{PHL} | | | | 5.5 | 7.9 | 1 | 9 | 1 | 10 | |

6.7 Operating Characteristics

$V_{CC} = 5 V, T_A = 25^\circ C$

| PARAMETER | TEST CONDITIONS | TYP | UNIT |
|--|------------------------------|-----|------|
| C_{pd} Power dissipation capacitance | No load, $f = 1 \text{ MHz}$ | 18 | pF |

6.8 Typical Characteristics

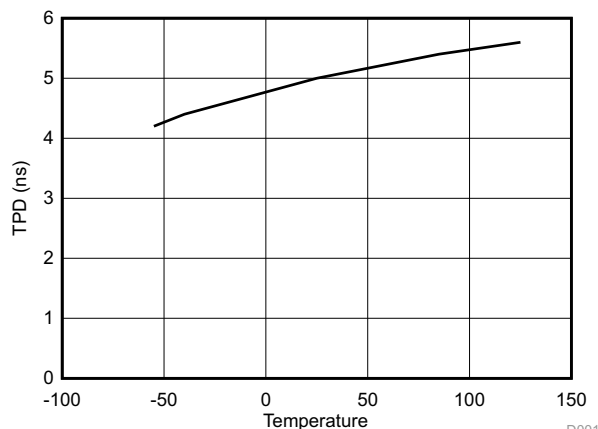
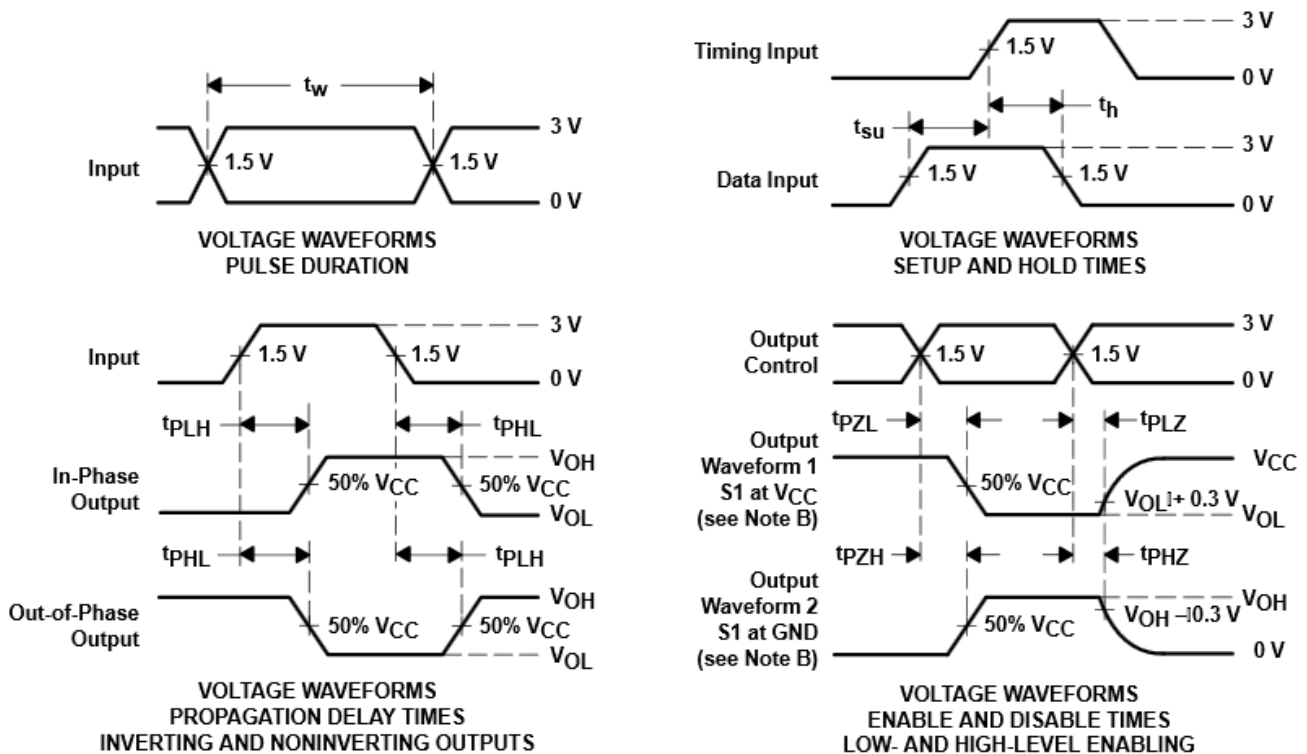
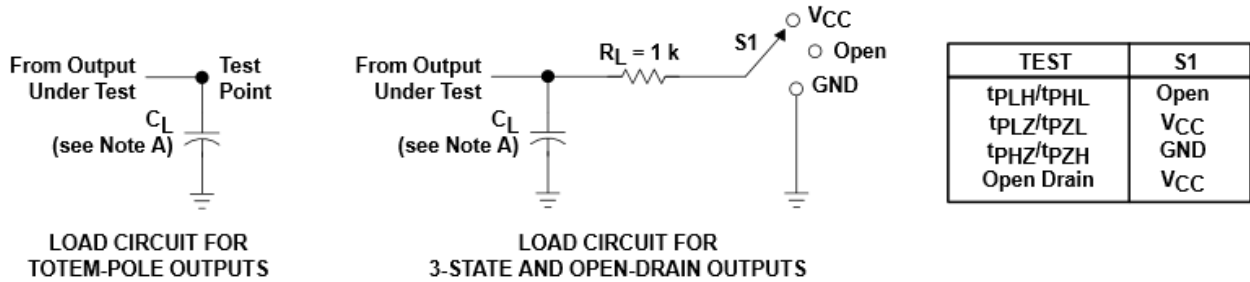

Figure 1. TPD vs. Temperature

7 Parameter Measurement Information



- NOTES:
- A. C_L includes probe and jig capacitance.
 - B. Waveform 1 is for an output with internal conditions such that the output is low except when disabled by the output control. Waveform 2 is for an output with internal conditions such that the output is high except when disabled by the output control.
 - C. All input pulses are supplied by generators having the following characteristics: PRR = 1 MHz, $Z_O = 50\ \Omega$, $t_r = 3\text{ ns}$, $t_f = 3\text{ ns}$.
 - D. The outputs are measured one at a time with one input transition per measurement.
 - E. All parameters and waveforms are not applicable to all devices.

Figure 2. Load Circuit and Voltage Waveforms

8 Detailed Description

8.1 Overview

The SN74AHCT1G86 is a single 2-input exclusive-OR gate. The device performs the Boolean function $Y = A \oplus B$ or $Y = \overline{A}B + A\overline{B}$ in positive logic.

To ensure the high-impedance state during power up or power down, OE should be tied to GND through a pulldown resistor; the minimum value of the resistor is determined by the current-sourcing capability of the driver.

8.2 Functional Block Diagram

An exclusive-OR gate has many applications, some of which can be represented better by alternative logic symbols.

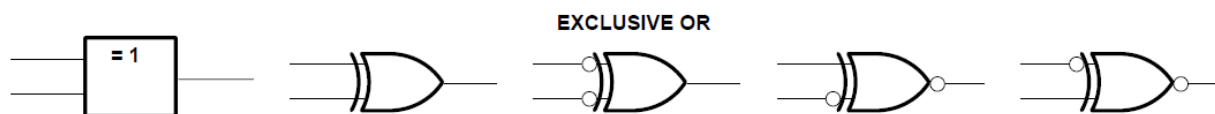

These five equivalent exclusive-OR symbols are valid for an SN74AHCT1G86 gate in positive logic; negation may be shown at any two ports.

LOGIC-IDENTITY ELEMENT

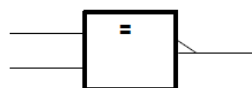

The output is active (low) if all inputs stand at the same logic level (i.e., $A = B$).

EVEN-PARITY ELEMENT

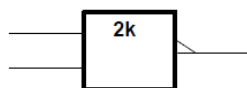

The output is active (low) if an even number of inputs (i.e., 0 or 2) are active.

ODD-PARITY ELEMENT

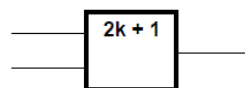

The output is active (high) if an odd number of inputs (i.e., only 1 of the 2) are active.

Figure 3. Exclusive-OR Logic

8.3 Feature Description

The device is ideal for operating in a 5-V logic system. The low propagation delay allows fast switching and higher speeds of operation. In addition, the low power consumption makes this device a good choice for portable and battery power-sensitive applications.

8.4 Device Functional Modes

Table 1. Function Table

| INPUTS | | OUTPUT |
|--------|---|--------|
| A | B | Y |
| L | L | L |
| L | H | H |
| H | L | H |
| H | H | L |

9 Application and Implementation

NOTE

Information in the following applications sections is not part of the TI component specification, and TI does not warrant its accuracy or completeness. TI's customers are responsible for determining suitability of components for their purposes. Customers should validate and test their design implementation to confirm system functionality.

9.1 Application Information

The SN74AHCT1G86 is a Low drive CMOS device that can be used for a multitude of bus interface type applications where output ringing is a concern. The low drive and slow edge rates will minimize overshoot and undershoot on the outputs. The input switching levels have been lowered to accommodate TTL inputs of 0.8-V V_{IL} and 2-V V_{IH} . This feature makes it Ideal for translating up from 3.3 V to 5 V.

9.2 Typical Application

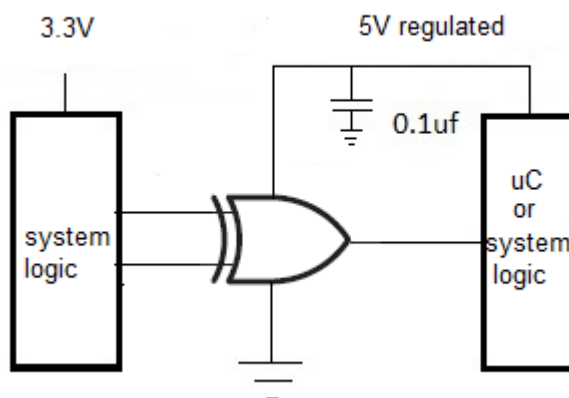

Figure 4. Typical Application Schematic

9.2.1 Design Requirements

This device uses CMOS technology and has balanced output drive. Take care to avoid bus contention because it can drive currents that would exceed maximum limits. The high drive will also create fast edges into light loads so consider routing and load conditions to prevent ringing.

9.2.2 Detailed Design Procedure

- Recommended input conditions:
 - Rise time and fall time specs. See $(\Delta t/\Delta V)$ in [Recommended Operating Conditions](#).
 - Specified high and low levels. See $(V_{IH}$ and $V_{IL})$ in [Recommended Operating Conditions](#).
- Recommended output conditions:
 - Load currents should not exceed 25 mA per output and 50 mA total for the part.
 - Outputs should not be pulled above V_{CC} .

Typical Application (continued)

9.2.3 Application Curves

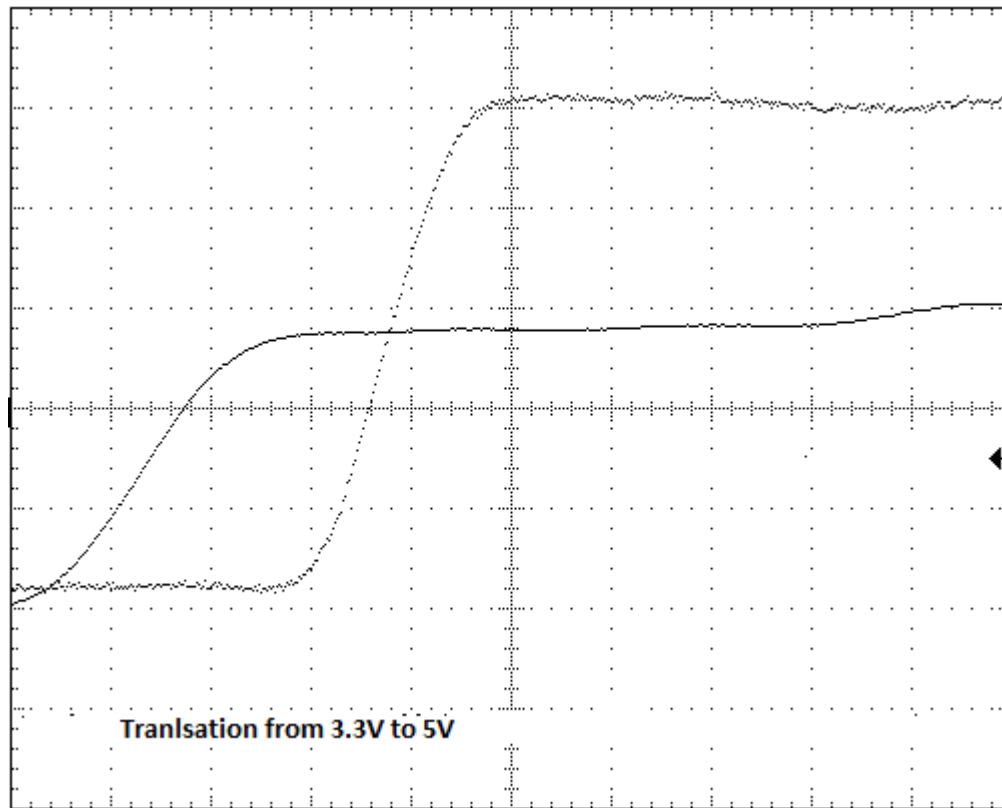

Figure 5. Translation From 3.3 V to 5.5 V

10 Power Supply Recommendations

The power supply can be any voltage between the minimum and maximum supply voltage rating located in the [Recommended Operating Conditions](#).

Each V_{CC} terminal should have a good bypass capacitor to prevent power disturbance. For devices with a single supply, TI recommends a 0.1- μF capacitor and if there are multiple V_{CC} terminals then TI recommends a 0.01- μF or 0.022- μF capacitor for each power terminal. Multiple bypass capacitors can be paralleled to reject different frequencies of noise. Frequencies of 0.1 μF and 1 μF are commonly used in parallel. The bypass capacitor should be installed as close as possible to the power terminal for best results.

11 Layout

11.1 Layout Guidelines

When using multiple bit logic devices inputs should not ever float.

In many cases, functions or parts of functions of digital logic devices are unused, for example, when only two inputs of a triple-input AND gate are used or only three of the four buffer gates are used. Such input pins should not be left unconnected because the undefined voltages at the outside connections result in undefined operational states. Specified below are the rules that must be observed under all circumstances. All unused inputs of digital logic devices must be connected to a high or low bias to prevent them from floating. The logic level that should be applied to any particular unused input depends on the function of the device. Generally they will be tied to GND or V_{CC} whichever make more sense or is more convenient. Floating outputs is generally acceptable, unless the part is a transceiver. If the transceiver has an output enable pin it will disable the outputs section of the part when asserted. This will not disable the input section of the I.O's so they also cannot float when disabled.

11.2 Layout Example

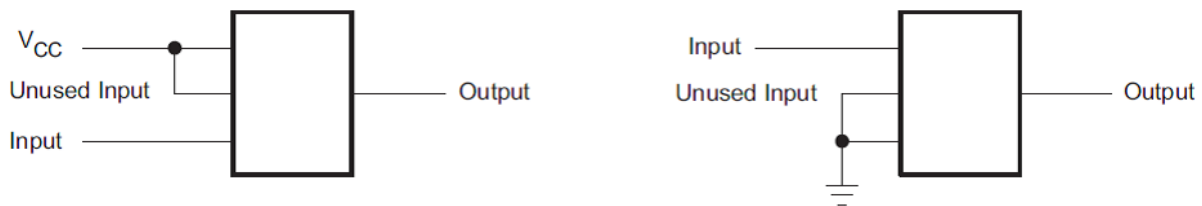

Figure 6. Layout Recommendation

12 Device and Documentation Support

12.1 Trademarks

All trademarks are the property of their respective owners.

12.2 Electrostatic Discharge Caution



These devices have limited built-in ESD protection. The leads should be shorted together or the device placed in conductive foam during storage or handling to prevent electrostatic damage to the MOS gates.

12.3 Glossary

[SLYZ022](#) — *TI Glossary*.

This glossary lists and explains terms, acronyms, and definitions.

13 Mechanical, Packaging, and Orderable Information

The following pages include mechanical, packaging, and orderable information. This information is the most current data available for the designated devices. This data is subject to change without notice and revision of this document. For browser-based versions of this data sheet, refer to the left-hand navigation.

PACKAGING INFORMATION

| Orderable Device | Status (1) | Package Type | Package Drawing | Pins | Package Qty | Eco Plan (2) | Lead finish/ Ball material (6) | MSL Peak Temp (3) | Op Temp (°C) | Device Marking (4/5) | Samples |
|------------------|---------------|--------------|-----------------|------|-------------|-----------------|--------------------------------------|----------------------|--------------|---------------------------|-------------------------|
| 74AHCT1G86DBVRG4 | ACTIVE | SOT-23 | DBV | 5 | 3000 | RoHS & Green | NIPDAU | Level-1-260C-UNLIM | -40 to 125 | B86G | Samples |
| 74AHCT1G86DBVTG4 | ACTIVE | SOT-23 | DBV | 5 | 250 | RoHS & Green | NIPDAU | Level-1-260C-UNLIM | -40 to 125 | B86G | Samples |
| SN74AHCT1G86DBVR | ACTIVE | SOT-23 | DBV | 5 | 3000 | RoHS & Green | NIPDAU SN | Level-1-260C-UNLIM | -40 to 125 | (B863, B86G, B86J, B86S) | Samples |
| SN74AHCT1G86DBVT | ACTIVE | SOT-23 | DBV | 5 | 250 | RoHS & Green | NIPDAU SN | Level-1-260C-UNLIM | -40 to 125 | (B863, B86G, B86J, B86S) | Samples |
| SN74AHCT1G86DCKR | ACTIVE | SC70 | DCK | 5 | 3000 | RoHS & Green | NIPDAU SN | Level-1-260C-UNLIM | -40 to 125 | (BH3, BHG, BHJ, BHL, BHS) | Samples |
| SN74AHCT1G86DCKT | ACTIVE | SC70 | DCK | 5 | 250 | RoHS & Green | NIPDAU SN | Level-1-260C-UNLIM | -40 to 125 | (BH3, BHG, BHJ, BHL, BHS) | Samples |

(1) The marketing status values are defined as follows:

ACTIVE: Product device recommended for new designs.

LIFEBUY: TI has announced that the device will be discontinued, and a lifetime-buy period is in effect.

NRND: Not recommended for new designs. Device is in production to support existing customers, but TI does not recommend using this part in a new design.

PREVIEW: Device has been announced but is not in production. Samples may or may not be available.

OBSOLETE: TI has discontinued the production of the device.

(2) **RoHS:** TI defines "RoHS" to mean semiconductor products that are compliant with the current EU RoHS requirements for all 10 RoHS substances, including the requirement that RoHS substance do not exceed 0.1% by weight in homogeneous materials. Where designed to be soldered at high temperatures, "RoHS" products are suitable for use in specified lead-free processes. TI may reference these types of products as "Pb-Free".

RoHS Exempt: TI defines "RoHS Exempt" to mean products that contain lead but are compliant with EU RoHS pursuant to a specific EU RoHS exemption.

Green: TI defines "Green" to mean the content of Chlorine (Cl) and Bromine (Br) based flame retardants meet JS709B low halogen requirements of <=1000ppm threshold. Antimony trioxide based flame retardants must also meet the <=1000ppm threshold requirement.

(3) MSL, Peak Temp. - The Moisture Sensitivity Level rating according to the JEDEC industry standard classifications, and peak solder temperature.

(4) There may be additional marking, which relates to the logo, the lot trace code information, or the environmental category on the device.

(5) Multiple Device Markings will be inside parentheses. Only one Device Marking contained in parentheses and separated by a "~" will appear on a device. If a line is indented then it is a continuation of the previous line and the two combined represent the entire Device Marking for that device.

⁽⁶⁾ Lead finish/Ball material - Orderable Devices may have multiple material finish options. Finish options are separated by a vertical ruled line. Lead finish/Ball material values may wrap to two lines if the finish value exceeds the maximum column width.

Important Information and Disclaimer:The information provided on this page represents TI's knowledge and belief as of the date that it is provided. TI bases its knowledge and belief on information provided by third parties, and makes no representation or warranty as to the accuracy of such information. Efforts are underway to better integrate information from third parties. TI has taken and continues to take reasonable steps to provide representative and accurate information but may not have conducted destructive testing or chemical analysis on incoming materials and chemicals. TI and TI suppliers consider certain information to be proprietary, and thus CAS numbers and other limited information may not be available for release.

In no event shall TI's liability arising out of such information exceed the total purchase price of the TI part(s) at issue in this document sold by TI to Customer on an annual basis.

OTHER QUALIFIED VERSIONS OF SN74AHCT1G86 :

- Automotive: [SN74AHCT1G86-Q1](#)

NOTE: Qualified Version Definitions:

- Automotive - Q100 devices qualified for high-reliability automotive applications targeting zero defects

TAPE AND REEL INFORMATION



QUADRANT ASSIGNMENTS FOR PIN 1 ORIENTATION IN TAPE



*All dimensions are nominal

| Device | Package Type | Package Drawing | Pins | SPQ | Reel Diameter (mm) | Reel Width W1 (mm) | A0 (mm) | B0 (mm) | K0 (mm) | P1 (mm) | W (mm) | Pin1 Quadrant |
|------------------|--------------|-----------------|------|------|--------------------|--------------------|---------|---------|---------|---------|--------|---------------|
| 74AHCT1G86DBVRG4 | SOT-23 | DBV | 5 | 3000 | 178.0 | 9.0 | 3.23 | 3.17 | 1.37 | 4.0 | 8.0 | Q3 |
| 74AHCT1G86DBVTG4 | SOT-23 | DBV | 5 | 250 | 178.0 | 9.0 | 3.23 | 3.17 | 1.37 | 4.0 | 8.0 | Q3 |
| SN74AHCT1G86DBVR | SOT-23 | DBV | 5 | 3000 | 180.0 | 8.4 | 3.23 | 3.17 | 1.37 | 4.0 | 8.0 | Q3 |
| SN74AHCT1G86DBVR | SOT-23 | DBV | 5 | 3000 | 178.0 | 9.0 | 3.23 | 3.17 | 1.37 | 4.0 | 8.0 | Q3 |
| SN74AHCT1G86DBVR | SOT-23 | DBV | 5 | 3000 | 178.0 | 9.2 | 3.3 | 3.23 | 1.55 | 4.0 | 8.0 | Q3 |
| SN74AHCT1G86DBVR | SOT-23 | DBV | 5 | 3000 | 178.0 | 9.0 | 3.3 | 3.2 | 1.4 | 4.0 | 8.0 | Q3 |
| SN74AHCT1G86DBVT | SOT-23 | DBV | 5 | 250 | 178.0 | 9.0 | 3.3 | 3.2 | 1.4 | 4.0 | 8.0 | Q3 |
| SN74AHCT1G86DBVT | SOT-23 | DBV | 5 | 250 | 178.0 | 9.2 | 3.3 | 3.23 | 1.55 | 4.0 | 8.0 | Q3 |
| SN74AHCT1G86DBVT | SOT-23 | DBV | 5 | 250 | 180.0 | 8.4 | 3.23 | 3.17 | 1.37 | 4.0 | 8.0 | Q3 |
| SN74AHCT1G86DBVT | SOT-23 | DBV | 5 | 250 | 178.0 | 9.0 | 3.23 | 3.17 | 1.37 | 4.0 | 8.0 | Q3 |
| SN74AHCT1G86DCKR | SC70 | DCK | 5 | 3000 | 178.0 | 9.0 | 2.4 | 2.5 | 1.2 | 4.0 | 8.0 | Q3 |
| SN74AHCT1G86DCKR | SC70 | DCK | 5 | 3000 | 180.0 | 8.4 | 2.47 | 2.3 | 1.25 | 4.0 | 8.0 | Q3 |
| SN74AHCT1G86DCKR | SC70 | DCK | 5 | 3000 | 178.0 | 9.2 | 2.4 | 2.4 | 1.22 | 4.0 | 8.0 | Q3 |
| SN74AHCT1G86DCKT | SC70 | DCK | 5 | 250 | 178.0 | 9.2 | 2.4 | 2.4 | 1.22 | 4.0 | 8.0 | Q3 |
| SN74AHCT1G86DCKT | SC70 | DCK | 5 | 250 | 178.0 | 9.0 | 2.4 | 2.5 | 1.2 | 4.0 | 8.0 | Q3 |

TAPE AND REEL BOX DIMENSIONS

*All dimensions are nominal

| Device | Package Type | Package Drawing | Pins | SPQ | Length (mm) | Width (mm) | Height (mm) |
|------------------|--------------|-----------------|------|------|-------------|------------|-------------|
| 74AHCT1G86DBVRG4 | SOT-23 | DBV | 5 | 3000 | 180.0 | 180.0 | 18.0 |
| 74AHCT1G86DBVTG4 | SOT-23 | DBV | 5 | 250 | 180.0 | 180.0 | 18.0 |
| SN74AHCT1G86DBVR | SOT-23 | DBV | 5 | 3000 | 202.0 | 201.0 | 28.0 |
| SN74AHCT1G86DBVR | SOT-23 | DBV | 5 | 3000 | 180.0 | 180.0 | 18.0 |
| SN74AHCT1G86DBVR | SOT-23 | DBV | 5 | 3000 | 180.0 | 180.0 | 18.0 |
| SN74AHCT1G86DBVR | SOT-23 | DBV | 5 | 3000 | 180.0 | 180.0 | 18.0 |
| SN74AHCT1G86DBVT | SOT-23 | DBV | 5 | 250 | 180.0 | 180.0 | 18.0 |
| SN74AHCT1G86DBVT | SOT-23 | DBV | 5 | 250 | 180.0 | 180.0 | 18.0 |
| SN74AHCT1G86DBVT | SOT-23 | DBV | 5 | 250 | 202.0 | 201.0 | 28.0 |
| SN74AHCT1G86DBVT | SOT-23 | DBV | 5 | 250 | 180.0 | 180.0 | 18.0 |
| SN74AHCT1G86DCKR | SC70 | DCK | 5 | 3000 | 180.0 | 180.0 | 18.0 |
| SN74AHCT1G86DCKR | SC70 | DCK | 5 | 3000 | 202.0 | 201.0 | 28.0 |
| SN74AHCT1G86DCKR | SC70 | DCK | 5 | 3000 | 180.0 | 180.0 | 18.0 |
| SN74AHCT1G86DCKT | SC70 | DCK | 5 | 250 | 180.0 | 180.0 | 18.0 |
| SN74AHCT1G86DCKT | SC70 | DCK | 5 | 250 | 180.0 | 180.0 | 18.0 |

EXAMPLE BOARD LAYOUT

DBV0005A

SOT-23 - 1.45 mm max height

SMALL OUTLINE TRANSISTOR

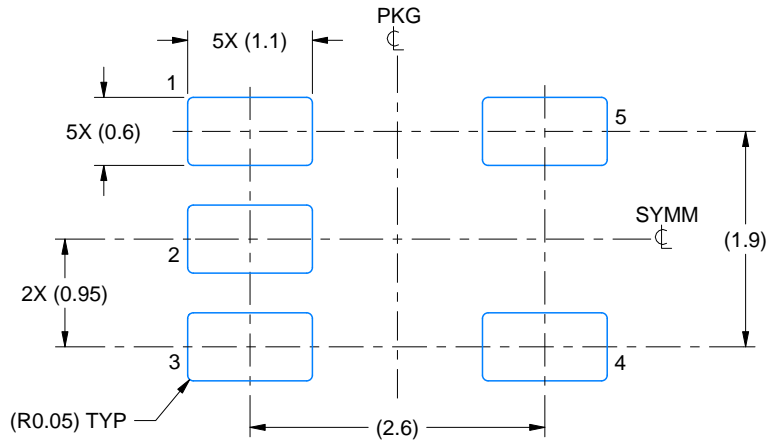

LAND PATTERN EXAMPLE
EXPOSED METAL SHOWN
SCALE:15X

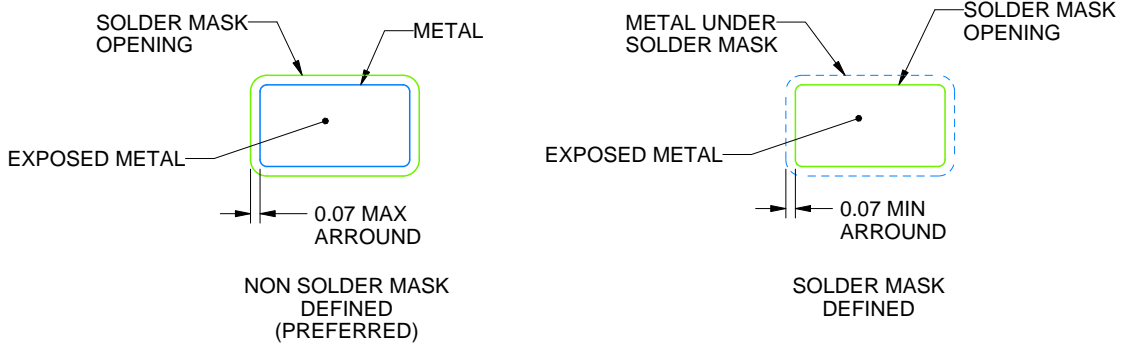

SOLDER MASK DETAILS

4214839/F 06/2021

NOTES: (continued)

- 5. Publication IPC-7351 may have alternate designs.
- 6. Solder mask tolerances between and around signal pads can vary based on board fabrication site.

EXAMPLE STENCIL DESIGN

DBV0005A

SOT-23 - 1.45 mm max height

SMALL OUTLINE TRANSISTOR

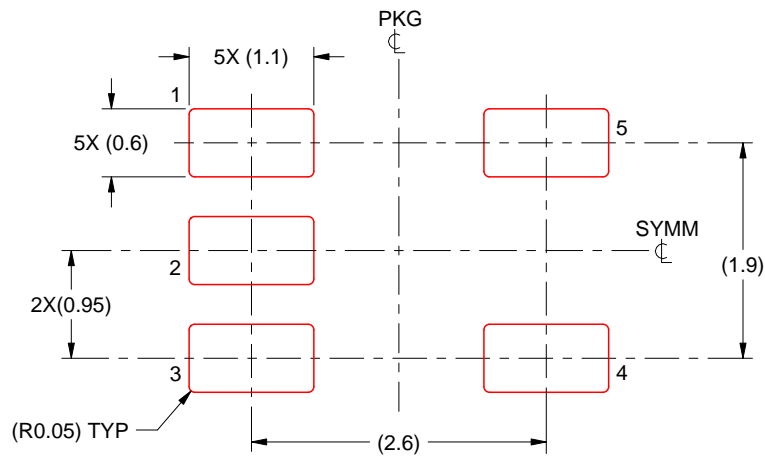

SOLDER PASTE EXAMPLE
BASED ON 0.125 mm THICK STENCIL
SCALE:15X

4214839/F 06/2021

NOTES: (continued)

7. Laser cutting apertures with trapezoidal walls and rounded corners may offer better paste release. IPC-7525 may have alternate design recommendations.
8. Board assembly site may have different recommendations for stencil design.

DCK (R-PDSO-G5)

PLASTIC SMALL OUTLINE

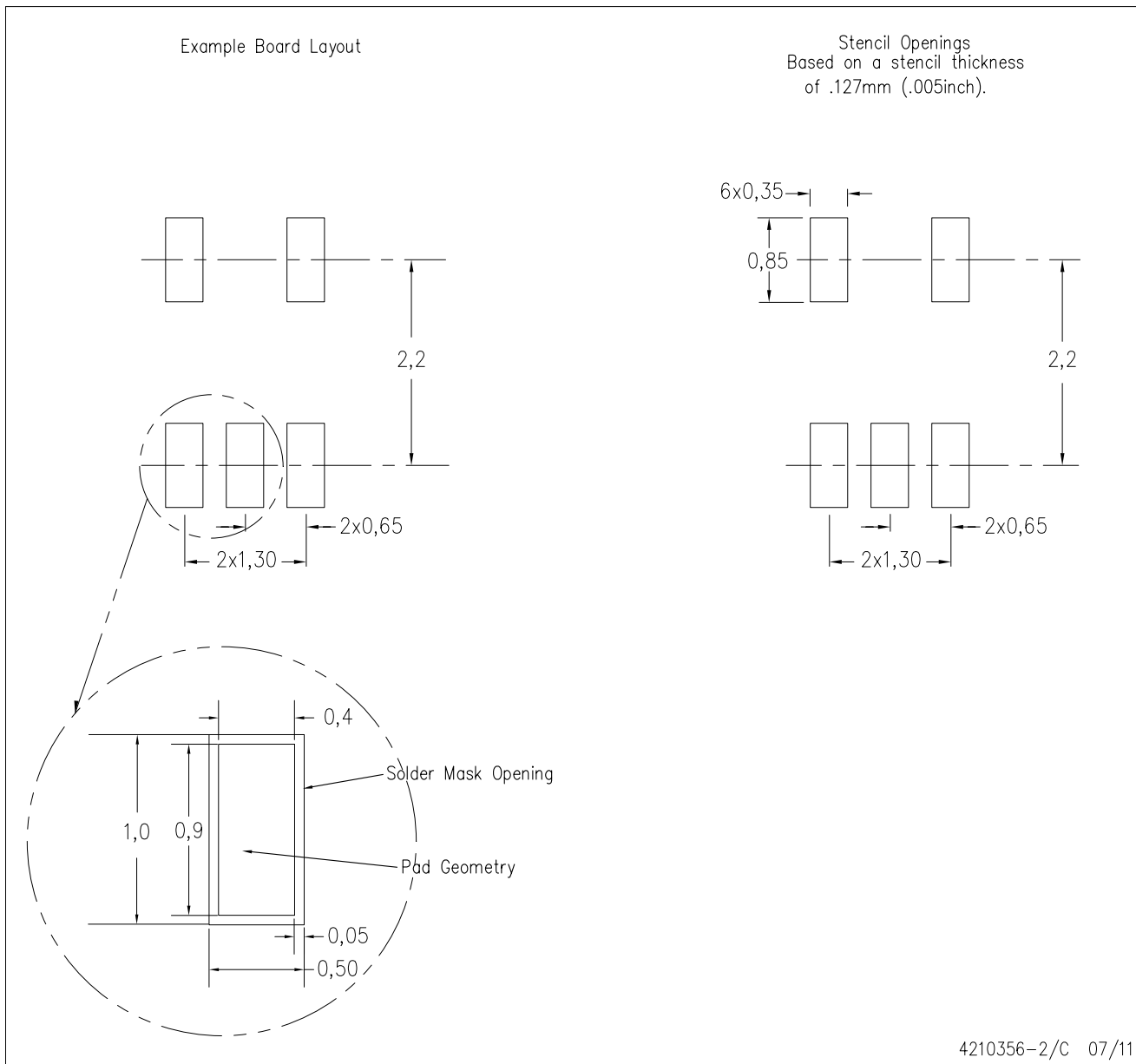

- NOTES:
- A. All linear dimensions are in millimeters.
 - B. This drawing is subject to change without notice.
 - C. Customers should place a note on the circuit board fabrication drawing not to alter the center solder mask defined pad.
 - D. Publication IPC-7351 is recommended for alternate designs.
 - E. Laser cutting apertures with trapezoidal walls and also rounding corners will offer better paste release. Customers should contact their board assembly site for stencil design recommendations. Example stencil design based on a 50% volumetric metal load solder paste. Refer to IPC-7525 for other stencil recommendations.

IMPORTANT NOTICE AND DISCLAIMER

TI PROVIDES TECHNICAL AND RELIABILITY DATA (INCLUDING DATASHEETS), DESIGN RESOURCES (INCLUDING REFERENCE DESIGNS), APPLICATION OR OTHER DESIGN ADVICE, WEB TOOLS, SAFETY INFORMATION, AND OTHER RESOURCES "AS IS" AND WITH ALL FAULTS, AND DISCLAIMS ALL WARRANTIES, EXPRESS AND IMPLIED, INCLUDING WITHOUT LIMITATION ANY IMPLIED WARRANTIES OF MERCHANTABILITY, FITNESS FOR A PARTICULAR PURPOSE OR NON-INFRINGEMENT OF THIRD PARTY INTELLECTUAL PROPERTY RIGHTS.

These resources are intended for skilled developers designing with TI products. You are solely responsible for (1) selecting the appropriate TI products for your application, (2) designing, validating and testing your application, and (3) ensuring your application meets applicable standards, and any other safety, security, or other requirements. These resources are subject to change without notice. TI grants you permission to use these resources only for development of an application that uses the TI products described in the resource. Other reproduction and display of these resources is prohibited. No license is granted to any other TI intellectual property right or to any third party intellectual property right. TI disclaims responsibility for, and you will fully indemnify TI and its representatives against, any claims, damages, costs, losses, and liabilities arising out of your use of these resources.

TI's products are provided subject to TI's Terms of Sale (<https://www.ti.com/legal/termsofsale.html>) or other applicable terms available either on [ti.com](https://www.ti.com) or provided in conjunction with such TI products. TI's provision of these resources does not expand or otherwise alter TI's applicable warranties or warranty disclaimers for TI products.

Mailing Address: Texas Instruments, Post Office Box 655303, Dallas, Texas 75265
Copyright © 2021, Texas Instruments Incorporated