

## SNx4AHC02 四路双输入正与非门

### 1 特性

- 工作电压范围：2V 至 5.5V
- 闩锁性能超过 250mA，符合 JESD 17 规范的要求

### 2 说明

'AHC02 器件包含四个独立的双输入或非门，这些门以正逻辑执行布尔函数  $\overline{A \bullet B}$  或  $Y = A + B$ 。

#### 器件信息

器件型号	封装 <sup>1</sup>	封装尺寸 <sup>2</sup>
SN54AHC02	J ( CDIP , 14 )	19.56mm x 6.67mm
	W ( CFP , 14 )	9.21 mm x 6.3 mm
	FK ( LCCC , 20 )	8.89mm x 8.89mm
SN74AHC02	D ( SOIC , 14 )	8.65 mm x 1.58 mm
	DB ( SSOP , 14 )	6.20 mm x 1.95 mm
	DGV ( TVSOP , 14 )	3.60 mm x 1.05 mm
	N ( PDIP , 14 )	19.30 mm x 6.30 mm
	NS ( SOP , 14 )	10.30 mm x 1.95 mm
	PW ( SOP , 14 )	5.00mm x 4.40mm
	RGY ( VQFN , 14 )	3.50 mm x 0.90 mm
	BQA ( WQFN , 14 )	3mm x 2.5mm

1. 如需了解所有可用封装，请参阅数据表末尾的可订购产品附录。
2. 封装尺寸（长 x 宽）为标称值，并包括引脚（如适用）。

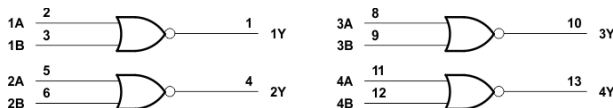

所示引脚编号用于 D、DB、DGV、J、N、NS、PW、RGY 和 W 封装。

图 2-1. 逻辑图（正逻辑）



## Table of Contents

<b>1 特性</b> .....	<b>1</b>	5.9 Operating Characteristics.....	<b>6</b>
<b>2 说明</b> .....	<b>1</b>	<b>6 Parameter Measurement Information</b> .....	<b>7</b>
<b>3 Revision History</b> .....	<b>2</b>	<b>7 Detailed Description</b> .....	<b>8</b>
<b>4 Pin Configuration and Functions</b> .....	<b>3</b>	7.1 Functional Block Diagram.....	<b>8</b>
<b>5 Specifications</b> .....	<b>4</b>	7.2 Device Functional Modes.....	<b>8</b>
5.1 Absolute Maximum Ratings.....	<b>4</b>	<b>8 Device and Documentation Support</b> .....	<b>9</b>
5.2 ESD Ratings.....	<b>4</b>	8.1 Documentation Support.....	<b>9</b>
5.3 Recommended Operating Conditions .....	<b>4</b>	8.2 接收文档更新通知.....	<b>9</b>
5.4 Thermal Information.....	<b>5</b>	8.3 支持资源.....	<b>9</b>
5.5 Electrical Characteristics.....	<b>5</b>	8.4 Trademarks.....	<b>9</b>
5.6 Switching Characteristics, $V_{CC} = 3.3 V \pm 0.3 V$ .....	<b>5</b>	8.5 静电放电警告.....	<b>9</b>
5.7 Switching Characteristics, $V_{CC} = 5 V \pm 0.5 V$ .....	<b>6</b>	8.6 术语表.....	<b>9</b>
5.8 Noise Characteristics.....	<b>6</b>	<b>9 Mechanical, Packaging, and Orderable Information..</b>	<b>10</b>

### 3 Revision History

注：以前版本的页码可能与当前版本的页码不同

<b>Changes from Revision L (May 2013) to Revision M (June 2023)</b>	<b>Page</b>
• 添加了封装信息表、引脚功能表、ESD 等级表、热信息表、器件功能模式、器件和文档支持部分以及机械、封装和可订购信息部分.....	<b>1</b>
• 向封装信息表中添加了 BQA 封装.....	<b>1</b>
• Updated thermal values for $R^{\theta} JA$ : D = 86 to 124.5, PW = 113 to 147.7, all values in $^{\circ}C/W$ .....	<b>5</b>
• Added thermal value for $R^{\theta} JA$ : BQA = 88.3, all values in $^{\circ}C/W$ .....	<b>5</b>

  

<b>Changes from Revision K (July 2003) to Revision L (May 2013)</b>	<b>Page</b>
• 将文档格式从 Quicksilver 变更为 DocZone.....	<b>1</b>
• Extended operating temperature range to $125^{\circ}C$ .....	<b>4</b>

## 4 Pin Configuration and Functions

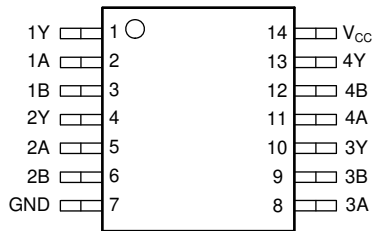

**图 4-1. SN54AHC02 J or W Package, 14-Pin (Top View)**  
**SN74AHC02 D, DB, DGV, N, NS, or PW Package, 14-Pin (Top View)**

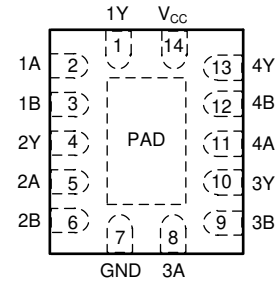

**图 4-2. SN74AHC02 RGY or BQA Package, 14-Pin (Top View)**

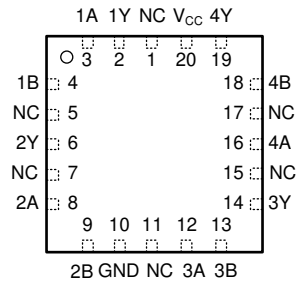

**图 4-3. SN54AHC02 FK Package, 20-Pin (Top View)**

**表 4-1. Pin Functions**

NAME	PIN			TYPE <sup>1</sup>	DESCRIPTION
	SN74AHC02	SN54AHC02			
	D, DB, DGV, N, NS, PW, RGY, BQA	J, W	FK		
1A	2	2	3	I	1A Input
1B	3	3	4	I	1B Input
1Y	1	1	2	O	1Y Output
2A	5	5	8	I	2A Input
2B	6	6	9	I	2B Input
2Y	4	4	6	O	2Y Output
3A	8	8	12	I	3A Input
3B	9	9	13	I	3B Input
3Y	10	20	14	O	3Y Output
4A	11	11	16	I	4A Input
4B	12	12	18	I	4B Input
4Y	13	13	19	O	4Y Output
GND	7	7	10	—	Ground Pin
NC	—	—	1, 5, 7, 11, 15, 17	—	No Connection
V <sub>CC</sub>	14	14	20	—	Power Pin

(1) I = input, O = output

## 5 Specifications

### 5.1 Absolute Maximum Ratings

over operating free-air temperature range (unless otherwise noted)<sup>(1)</sup>

		MIN	MAX	UNIT
V <sub>CC</sub>	Supply voltage range	- 0.5	7	V
V <sub>I</sub> <sup>(2)</sup>	Input voltage range	- 0.5	7	V
V <sub>O</sub> <sup>(2)</sup>	Output voltage range	- 0.5	V <sub>CC</sub> + 0.5	V
I <sub>IK</sub>	Input clamp current (V <sub>I</sub> < 0)		- 20	mA
I <sub>OK</sub>	Output clamp current (V <sub>O</sub> < 0 or V <sub>O</sub> > V <sub>CC</sub> )		±20	mA
I <sub>O</sub>	Continuous output current (V <sub>O</sub> = 0 to V <sub>CC</sub> )		±25	mA
Continuous current through V <sub>CC</sub> or GND			±50	mA
T <sub>stg</sub>	Storage temperature range	- 65	150	°C

- (1) Stresses beyond those listed under “absolute maximum ratings” may cause permanent damage to the device. These are stress ratings only, and functional operation of the device at these or any other conditions beyond those indicated under “recommended operating conditions” is not implied. Exposure to absolute-maximum-rated conditions for extended periods may affect device reliability.
- (2) The input and output voltage ratings may be exceeded if the input and output current ratings are observed.

### 5.2 ESD Ratings

			VALUE	UNIT
V <sub>(ESD)</sub>	Electrostatic discharge	Human-body model (HBM)	±2000	V
		Charged device model (CDM),	±1000	

### 5.3 Recommended Operating Conditions

		SN54AHC02		SN74AHC02		UNIT
		MIN	MAX	MIN	MAX	
V <sub>CC</sub>	Supply voltage	2	5.5	2	5.5	V
V <sub>IH</sub>	High-level input voltage	V <sub>CC</sub> = 2 V	1.5	1.5		V
		V <sub>CC</sub> = 3 V	2.1	2.1		
		V <sub>CC</sub> = 5.5 V	3.85	3.85		
V <sub>IL</sub>	Low-level Input voltage	V <sub>CC</sub> = 2 V		0.5	0.5	V
		V <sub>CC</sub> = 3 V		0.9	0.9	
		V <sub>CC</sub> = 5.5 V		1.65	1.65	
V <sub>I</sub>	Input voltage	0	5.5	0	5.5	V
V <sub>O</sub>	Output voltage	0	V <sub>CC</sub>	0	V <sub>CC</sub>	V
I <sub>OH</sub>	High-level output current	V <sub>CC</sub> = 2 V		- 50	- 50	mA
		V <sub>CC</sub> = 3.3 V ± 0.3 V		- 4	- 4	
		V <sub>CC</sub> = 5 V ± 0.5 V		- 8	- 8	
I <sub>OL</sub>	Low-level output current	V <sub>CC</sub> = 2 V		50	50	mA
		V <sub>CC</sub> = 3.3 V ± 0.3 V		4	4	
		V <sub>CC</sub> = 5 V ± 0.5 V		8	8	
Δt/Δv	Input Transition rise or fall rate	V <sub>CC</sub> = 3.3 V ± 0.3 V		100	100	ns/V
		V <sub>CC</sub> = 5 V ± 0.5 V		20	20	
T <sub>A</sub>	Operating free-air temperature	- 55	125	- 40	125	°C

## 5.4 Thermal Information

THERMAL METRIC <sup>(1)</sup>		SN74AHC02								UNIT
		D	DB	DGV	N	NS	PW	RGY	BQA	
		14 PINS	14 PINS	14 PINS	14 PINS	14 PINS	14 PINS	14 PINS	14 PINS	
R <sub>θJA</sub>	Junction-to-ambient thermal resistance	124.5	96	127	80	76	147.7	47	88.3	°C/W

(1) For more information about traditional and new thermal metrics, see the *IC Package Thermal Metrics* application report, [SPRA953](#).

## 5.5 Electrical Characteristics

over operating free-air temperature range (unless otherwise noted)<sup>1</sup>

PARAMETER	TEST CONDITIONS	V <sub>CC</sub>	T <sub>A</sub> = 25°C			T <sub>A</sub> = -55°C TO 125°C		T <sub>A</sub> = -40°C TO 85°C		T <sub>A</sub> = -40°C TO 125°C		UNIT
						SN54AHC02		SN74AHC02		Recommended SN74AHC02		
			MIN	TYP	MAX	MIN	MAX	MIN	MAX	MIN	MAX	
V <sub>OH</sub>	I <sub>OH</sub> = -50 μA	2 V	1.9	2	1.9		1.9		1.9		V	
		3 V	2.9	3	2.9		2.9		2.9			
		4.5 V	4.4	4.5	4.4		4.4		4.4			
	I <sub>OH</sub> = -4 mA	3 V	2.58		2.48		2.48		2.48			
	I <sub>OH</sub> = -8 mA	4.5 V	3.94		3.8		3.8		3.8			
V <sub>OL</sub>	I <sub>OL</sub> = 50 μA	2 V			0.1		0.1		0.1		V	
		3 V			0.1		0.1		0.1			
		4.5 V			0.1		0.1		0.1			
	I <sub>OH</sub> = 4 mA	3 V			0.36		0.5		0.44			
	I <sub>OH</sub> = 8 mA	4.5 V			0.36		0.5		0.44			
I <sub>I</sub>	V <sub>I</sub> = 5.5 V or GND	0 V to 5.5 V			±0.1		±1 <sup>(1)</sup>		±1		μA	
I <sub>CC</sub>	V <sub>I</sub> = V <sub>CC</sub> or GND, I <sub>O</sub> = 0	5.5 V			2		20		20		μA	
C <sub>i</sub>	V <sub>I</sub> = V <sub>CC</sub> or GND	5 V			4		10		10		pF	

(1) On products compliant to MIL-PRF-38535, this parameter is not production tested at V<sub>CC</sub> = 0 V.

## 5.6 Switching Characteristics, V<sub>CC</sub> = 3.3 V ± 0.3 V

over recommended operating free-air temperature range, V<sub>CC</sub> = 3.3 V ± 0.3 V (unless otherwise noted) (see [Load Circuit and Voltage Waveforms](#))

PARAMETER	FROM (INPUT)	TO (OUTPUT)	LOAD CAPACITANCE	T <sub>A</sub> = 25°C		T <sub>A</sub> = -55°C TO 125°C		T <sub>A</sub> = -40°C TO 85°C		T <sub>A</sub> = -40°C TO 125°C		UNIT
						SN54AHC02		SN74AHC02		Recommended SN74AHC02		
				TYP	MAX	MIN	MAX	MIN	MAX	MIN	MAX	
t <sub>PLH</sub>	A or B	Y	C <sub>L</sub> = 15 pF	5.6 <sup>(1)</sup>	7.9 <sup>(1)</sup>	1 <sup>(1)</sup>	9.5 <sup>(1)</sup>	1	9.5	1	9.5	ns
t <sub>PHL</sub>				5.6 <sup>(1)</sup>	7.9 <sup>(1)</sup>	1 <sup>(1)</sup>	9.5 <sup>(1)</sup>	1	9.5	1	9.5	
t <sub>PLH</sub>	A or B	Y	C <sub>L</sub> = 50 pF	8.1	11.4	1	13	1	13	1	13	ns
t <sub>PHL</sub>				8.1	11.4	1	13	1	13	1	13	

(1) On products compliant to MIL-PRF-38535, this parameter is not production tested.

### 5.7 Switching Characteristics, $V_{CC} = 5 V \pm 0.5 V$

over recommended operating free-air temperature range,  $V_{CC} = 5 V \pm 0.5 V$  (unless otherwise noted) (see [Load Circuit and Voltage Waveforms](#))

PARAMETER	FROM (INPUT)	TO (OUTPUT)	LOAD CAPACITANCE	$T_A = 25^\circ C$		$T_A = -55^\circ C \text{ TO } 125^\circ C$		$T_A = -40^\circ C \text{ TO } 85^\circ C$		$T_A = -40^\circ C \text{ TO } 125^\circ C$		UNIT
				TYP	MAX	SN54AHC02		SN74AHC02		Recommended		
						MIN	MAX	MIN	MAX	MIN	MAX	
$t_{PLH}$	A or B	Y	$C_L = 15 \text{ pF}$	3.6 <sup>(1)</sup>	5.5 <sup>(1)</sup>	1 <sup>(1)</sup>	6.5 <sup>(1)</sup>	1	6.5	1	6.5	ns
$t_{PHL}$				3.6 <sup>(1)</sup>	5.5 <sup>(1)</sup>	1 <sup>(1)</sup>	6.5 <sup>(1)</sup>	1	6.5	1	6.5	
$t_{PLH}$	A or B	Y	$C_L = 50 \text{ pF}$	5.1		1	8.5	1	8.5	1	8.5	ns
$t_{PHL}$				5.1		1	8.5	1	8.5	1	8.5	

### 5.8 Noise Characteristics

$V_{CC} = 5 V$ ,  $C_L = 50 \text{ pF}$ ,  $T_A = 25^\circ C$ <sup>(1)</sup>

PARAMETER		SN74AHC02		UNIT
		MIN	MAX	
$V_{OL(P)}$	Quiet output, maximum dynamic $V_{OL}$	0.8		V
$V_{OL(V)}$	Quiet output, minimum dynamic $V_{OL}$	-0.8		V
$V_{OH(V)}$	Quiet output, minimum dynamic $V_{OH}$	4.9		V
$V_{IH(D)}$	High-level dynamic input voltage	3.5		V
$V_{IL(D)}$	Low-level dynamic input voltage	1.5		V

(1) Characteristics are for surface-mount packages only.

### 5.9 Operating Characteristics

$V_{CC} = 5 V$ ,  $T_A = 25^\circ C$

PARAMETER	TEST CONDITIONS	TYP	UNIT
$C_{pd}$	Power dissipation capacitance No load, $f = 1 \text{ MHz}$	15	pF

## 6 Parameter Measurement Information

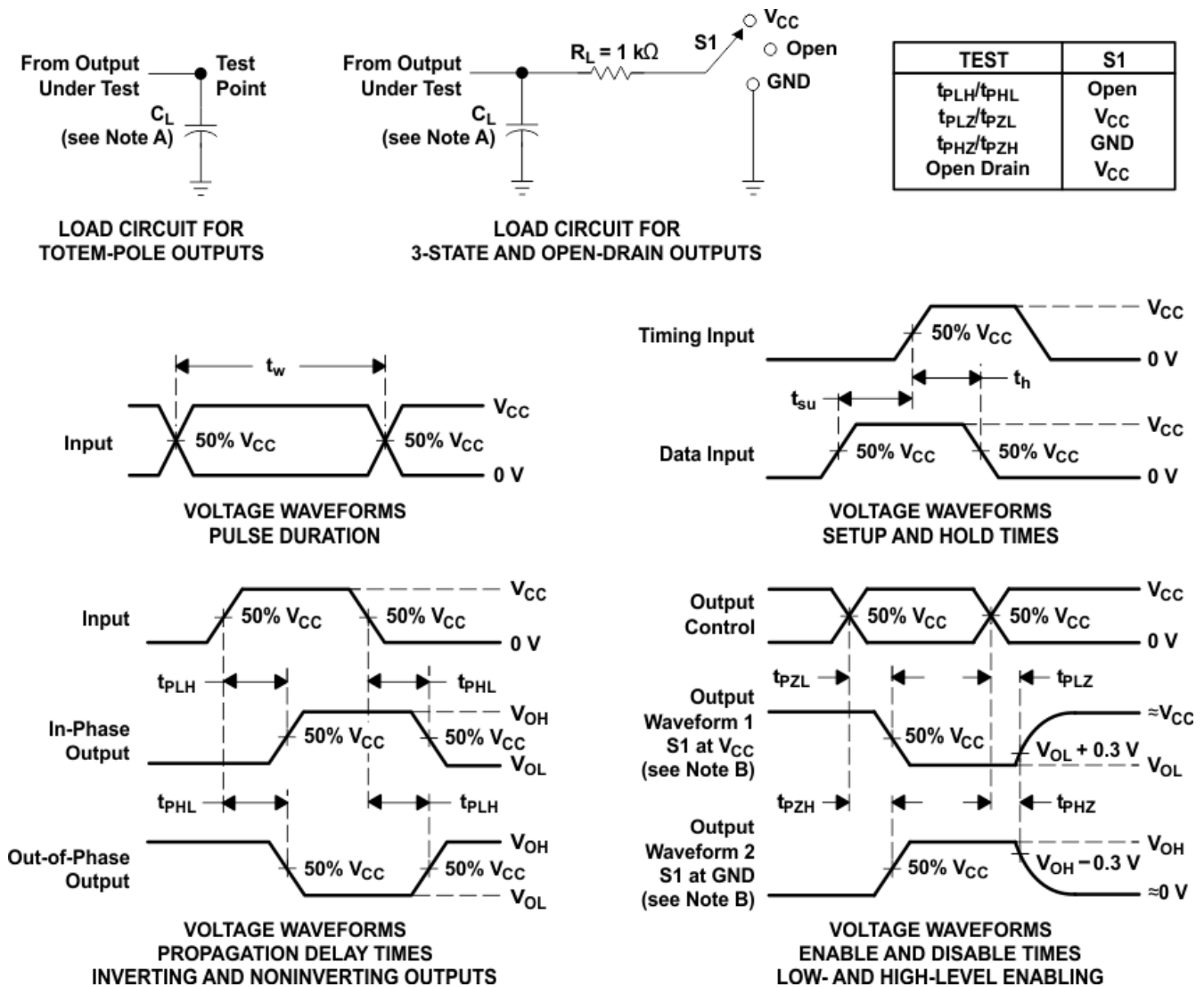

- A.  $C_L$  includes probe and jig capacitance.
- B. Waveform 1 is for an output with internal conditions such that the output is low except when disabled by the output control. Waveform 2 is for an output with internal conditions such that the output is high except when disabled by the output control.
- C. All input pulses are supplied by generators having the following characteristics:  $PRR \leq 1$  MHz,  $Z_O = 50 \Omega$ ,  $t_r \leq 3$  ns,  $t_f \leq 3$  ns.
- D. The outputs are measured one at a time with one input transition per measurement.
- E. All parameters and waveforms are not applicable to all devices.

图 6-1. Load Circuit and Voltage Waveforms

## 7 Detailed Description

### 7.1 Functional Block Diagram

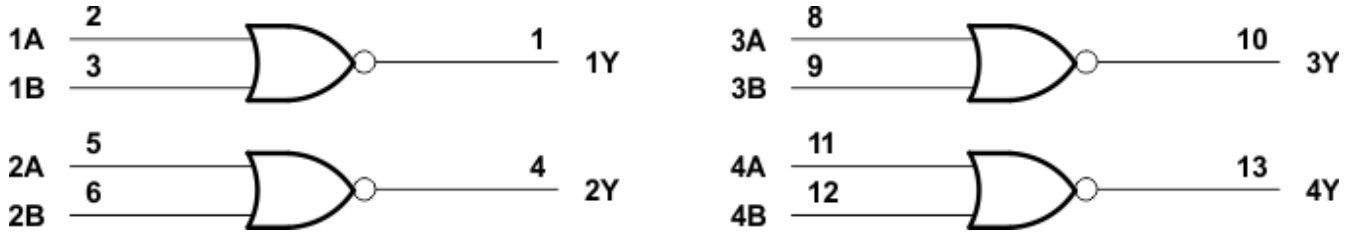

### 7.2 Device Functional Modes

表 7-1. Function Table

INPUTS <sup>(1)</sup>		OUTPUT Y
A	B	
H	X	L
X	H	L
L	L	H

- (1) H = High Voltage Level, L = Low Voltage Level, X = Don't Care

## 8 Device and Documentation Support

TI offers an extensive line of development tools. Tools and software to evaluate the performance of the device, generate code, and develop solutions are listed below.

### 8.1 Documentation Support

#### 8.1.1 Related Documentation

The table below lists quick access links. Categories include technical documents, support and community resources, tools and software, and quick access to sample or buy.

表 8-1. Related Links

PARTS	PRODUCT FOLDER	SAMPLE & BUY	TECHNICAL DOCUMENTS	TOOLS & SOFTWARE	SUPPORT & COMMUNITY
SN54AHC02	<a href="#">Click here</a>	<a href="#">Click here</a>	<a href="#">Click here</a>	<a href="#">Click here</a>	<a href="#">Click here</a>
SN74AHC02	<a href="#">Click here</a>	<a href="#">Click here</a>	<a href="#">Click here</a>	<a href="#">Click here</a>	<a href="#">Click here</a>

### 8.2 接收文档更新通知

要接收文档更新通知，请导航至 [ti.com](http://ti.com) 上的器件产品文件夹。点击 [订阅更新](#) 进行注册，即可每周接收产品信息更改摘要。有关更改的详细信息，请查看任何已修订文档中包含的修订历史记录。

### 8.3 支持资源

**TI E2E™ 支持论坛**是工程师的重要参考资料，可直接从专家获得快速、经过验证的解答和设计帮助。搜索现有解答或提出自己的问题可获得所需的快速设计帮助。

链接的内容由各个贡献者“按原样”提供。这些内容并不构成 TI 技术规范，并且不一定反映 TI 的观点；请参阅 TI 的《[使用条款](#)》。

### 8.4 Trademarks

TI E2E™ is a trademark of Texas Instruments.

所有商标均为其各自所有者的财产。

### 8.5 静电放电警告



静电放电 (ESD) 会损坏这个集成电路。德州仪器 (TI) 建议通过适当的预防措施处理所有集成电路。如果不遵守正确的处理和安装程序，可能会损坏集成电路。

ESD 的损坏小至导致微小的性能降级，大至整个器件故障。精密的集成电路可能更容易受到损坏，这是因为非常细微的参数更改都可能会导致器件与其发布的规格不相符。

### 8.6 术语表

**TI 术语表** 本术语表列出并解释了术语、首字母缩略词和定义。

## 9 Mechanical, Packaging, and Orderable Information

The following pages include mechanical, packaging, and orderable information. This information is the most current data available for the designated devices. This data is subject to change without notice and revision of this document. For browser-based versions of this data sheet, refer to the left-hand navigation.

**PACKAGING INFORMATION**

Orderable Device	Status (1)	Package Type	Package Drawing	Pins	Package Qty	Eco Plan (2)	Lead finish/ Ball material (6)	MSL Peak Temp (3)	Op Temp (°C)	Device Marking (4/5)	Samples
5962-9752801Q2A	ACTIVE	LCCC	FK	20	1	Non-RoHS & Green	SNPB	N / A for Pkg Type	-55 to 125	5962- 9752801Q2A SNJ54AHC 02FK	<a href="#">Samples</a>
5962-9752801QCA	ACTIVE	CDIP	J	14	1	Non-RoHS & Green	SNPB	N / A for Pkg Type	-55 to 125	5962-9752801QC A SNJ54AHC02J	<a href="#">Samples</a>
5962-9752801QDA	ACTIVE	CFP	W	14	1	Non-RoHS & Green	SNPB	N / A for Pkg Type	-55 to 125	5962-9752801QD A SNJ54AHC02W	<a href="#">Samples</a>
SN74AHC02BQAR	ACTIVE	WQFN	BQA	14	3000	RoHS & Green	NIPDAU	Level-1-260C-UNLIM	-40 to 125	AHC02	<a href="#">Samples</a>
SN74AHC02DBR	ACTIVE	SSOP	DB	14	2000	RoHS & Green	NIPDAU	Level-1-260C-UNLIM	-40 to 125	HA02	<a href="#">Samples</a>
SN74AHC02DGVR	ACTIVE	TVSOP	DGV	14	2000	RoHS & Green	NIPDAU	Level-1-260C-UNLIM	-40 to 125	HA02	<a href="#">Samples</a>
SN74AHC02DR	ACTIVE	SOIC	D	14	2500	RoHS & Green	NIPDAU	Level-1-260C-UNLIM	-40 to 125	AHC02	<a href="#">Samples</a>
SN74AHC02N	ACTIVE	PDIP	N	14	25	RoHS & Green	NIPDAU	N / A for Pkg Type	-40 to 125	SN74AHC02N	<a href="#">Samples</a>
SN74AHC02NSR	ACTIVE	SO	NS	14	2000	RoHS & Green	NIPDAU	Level-1-260C-UNLIM	-40 to 125	AHC02	<a href="#">Samples</a>
SN74AHC02PWR	ACTIVE	TSSOP	PW	14	2000	RoHS & Green	NIPDAU	Level-1-260C-UNLIM	-40 to 125	HA02	<a href="#">Samples</a>
SN74AHC02PWRE4	ACTIVE	TSSOP	PW	14	2000	RoHS & Green	NIPDAU	Level-1-260C-UNLIM	-40 to 125	HA02	<a href="#">Samples</a>
SN74AHC02RGYR	ACTIVE	VQFN	RGY	14	3000	RoHS & Green	NIPDAU	Level-2-260C-1 YEAR	-40 to 125	HA02	<a href="#">Samples</a>
SNJ54AHC02FK	ACTIVE	LCCC	FK	20	1	Non-RoHS & Green	SNPB	N / A for Pkg Type	-55 to 125	5962- 9752801Q2A SNJ54AHC 02FK	<a href="#">Samples</a>
SNJ54AHC02J	ACTIVE	CDIP	J	14	1	Non-RoHS & Green	SNPB	N / A for Pkg Type	-55 to 125	5962-9752801QC A SNJ54AHC02J	<a href="#">Samples</a>
SNJ54AHC02W	ACTIVE	CFP	W	14	1	Non-RoHS & Green	SNPB	N / A for Pkg Type	-55 to 125	5962-9752801QD A SNJ54AHC02W	<a href="#">Samples</a>

(1) The marketing status values are defined as follows:

**ACTIVE:** Product device recommended for new designs.

**LIFEBUY:** TI has announced that the device will be discontinued, and a lifetime-buy period is in effect.

**NRND:** Not recommended for new designs. Device is in production to support existing customers, but TI does not recommend using this part in a new design.

**PREVIEW:** Device has been announced but is not in production. Samples may or may not be available.

**OBSOLETE:** TI has discontinued the production of the device.

(2) **RoHS:** TI defines "RoHS" to mean semiconductor products that are compliant with the current EU RoHS requirements for all 10 RoHS substances, including the requirement that RoHS substance do not exceed 0.1% by weight in homogeneous materials. Where designed to be soldered at high temperatures, "RoHS" products are suitable for use in specified lead-free processes. TI may reference these types of products as "Pb-Free".

**RoHS Exempt:** TI defines "RoHS Exempt" to mean products that contain lead but are compliant with EU RoHS pursuant to a specific EU RoHS exemption.

**Green:** TI defines "Green" to mean the content of Chlorine (Cl) and Bromine (Br) based flame retardants meet JS709B low halogen requirements of  $\leq 1000$ ppm threshold. Antimony trioxide based flame retardants must also meet the  $\leq 1000$ ppm threshold requirement.

(3) MSL, Peak Temp. - The Moisture Sensitivity Level rating according to the JEDEC industry standard classifications, and peak solder temperature.

(4) There may be additional marking, which relates to the logo, the lot trace code information, or the environmental category on the device.

(5) Multiple Device Markings will be inside parentheses. Only one Device Marking contained in parentheses and separated by a "~" will appear on a device. If a line is indented then it is a continuation of the previous line and the two combined represent the entire Device Marking for that device.

(6) Lead finish/Ball material - Orderable Devices may have multiple material finish options. Finish options are separated by a vertical ruled line. Lead finish/Ball material values may wrap to two lines if the finish value exceeds the maximum column width.

**Important Information and Disclaimer:**The information provided on this page represents TI's knowledge and belief as of the date that it is provided. TI bases its knowledge and belief on information provided by third parties, and makes no representation or warranty as to the accuracy of such information. Efforts are underway to better integrate information from third parties. TI has taken and continues to take reasonable steps to provide representative and accurate information but may not have conducted destructive testing or chemical analysis on incoming materials and chemicals. TI and TI suppliers consider certain information to be proprietary, and thus CAS numbers and other limited information may not be available for release.

In no event shall TI's liability arising out of such information exceed the total purchase price of the TI part(s) at issue in this document sold by TI to Customer on an annual basis.

#### OTHER QUALIFIED VERSIONS OF SN54AHC02, SN74AHC02 :

- Catalog : [SN74AHC02](#)
- Automotive : [SN74AHC02-Q1](#), [SN74AHC02-Q1](#)
- Enhanced Product : [SN74AHC02-EP](#), [SN74AHC02-EP](#)

- Military : [SN54AHC02](#)

NOTE: Qualified Version Definitions:

- Catalog - TI's standard catalog product
- Automotive - Q100 devices qualified for high-reliability automotive applications targeting zero defects
- Enhanced Product - Supports Defense, Aerospace and Medical Applications
- Military - QML certified for Military and Defense Applications

**TAPE AND REEL INFORMATION**

**QUADRANT ASSIGNMENTS FOR PIN 1 ORIENTATION IN TAPE**

\*All dimensions are nominal

Device	Package Type	Package Drawing	Pins	SPQ	Reel Diameter (mm)	Reel Width W1 (mm)	A0 (mm)	B0 (mm)	K0 (mm)	P1 (mm)	W (mm)	Pin1 Quadrant
SN74AHC02BQAR	WQFN	BQA	14	3000	180.0	12.4	2.8	3.3	1.1	4.0	12.0	Q1
SN74AHC02DBR	SSOP	DB	14	2000	330.0	16.4	8.35	6.6	2.4	12.0	16.0	Q1
SN74AHC02DGVR	TVSOP	DGV	14	2000	330.0	12.4	6.8	4.0	1.6	8.0	12.0	Q1
SN74AHC02DR	SOIC	D	14	2500	330.0	16.4	6.5	9.0	2.1	8.0	16.0	Q1
SN74AHC02NSR	SO	NS	14	2000	330.0	16.4	8.2	10.5	2.5	12.0	16.0	Q1
SN74AHC02PWR	TSSOP	PW	14	2000	330.0	12.4	6.9	5.6	1.6	8.0	12.0	Q1
SN74AHC02RGYR	VQFN	RGY	14	3000	330.0	12.4	3.75	3.75	1.15	8.0	12.0	Q1

**TAPE AND REEL BOX DIMENSIONS**

\*All dimensions are nominal

Device	Package Type	Package Drawing	Pins	SPQ	Length (mm)	Width (mm)	Height (mm)
SN74AHC02BQAR	WQFN	BQA	14	3000	210.0	185.0	35.0
SN74AHC02DBR	SSOP	DB	14	2000	356.0	356.0	35.0
SN74AHC02DGVR	TVSOP	DGV	14	2000	356.0	356.0	35.0
SN74AHC02DR	SOIC	D	14	2500	356.0	356.0	35.0
SN74AHC02NSR	SO	NS	14	2000	356.0	356.0	35.0
SN74AHC02PWR	TSSOP	PW	14	2000	356.0	356.0	35.0
SN74AHC02RGYR	VQFN	RGY	14	3000	356.0	356.0	35.0

**TUBE**

\*All dimensions are nominal

Device	Package Name	Package Type	Pins	SPQ	L (mm)	W (mm)	T (μm)	B (mm)
5962-9752801Q2A	FK	LCCC	20	1	506.98	12.06	2030	NA
5962-9752801QDA	W	CFP	14	1	506.98	26.16	6220	NA
SN74AHC02N	N	PDIP	14	25	506	13.97	11230	4.32
SN74AHC02N	N	PDIP	14	25	506	13.97	11230	4.32
SNJ54AHC02FK	FK	LCCC	20	1	506.98	12.06	2030	NA
SNJ54AHC02W	W	CFP	14	1	506.98	26.16	6220	NA

RGY (S-PVQFN-N14)

PLASTIC QUAD FLATPACK NO-LEAD

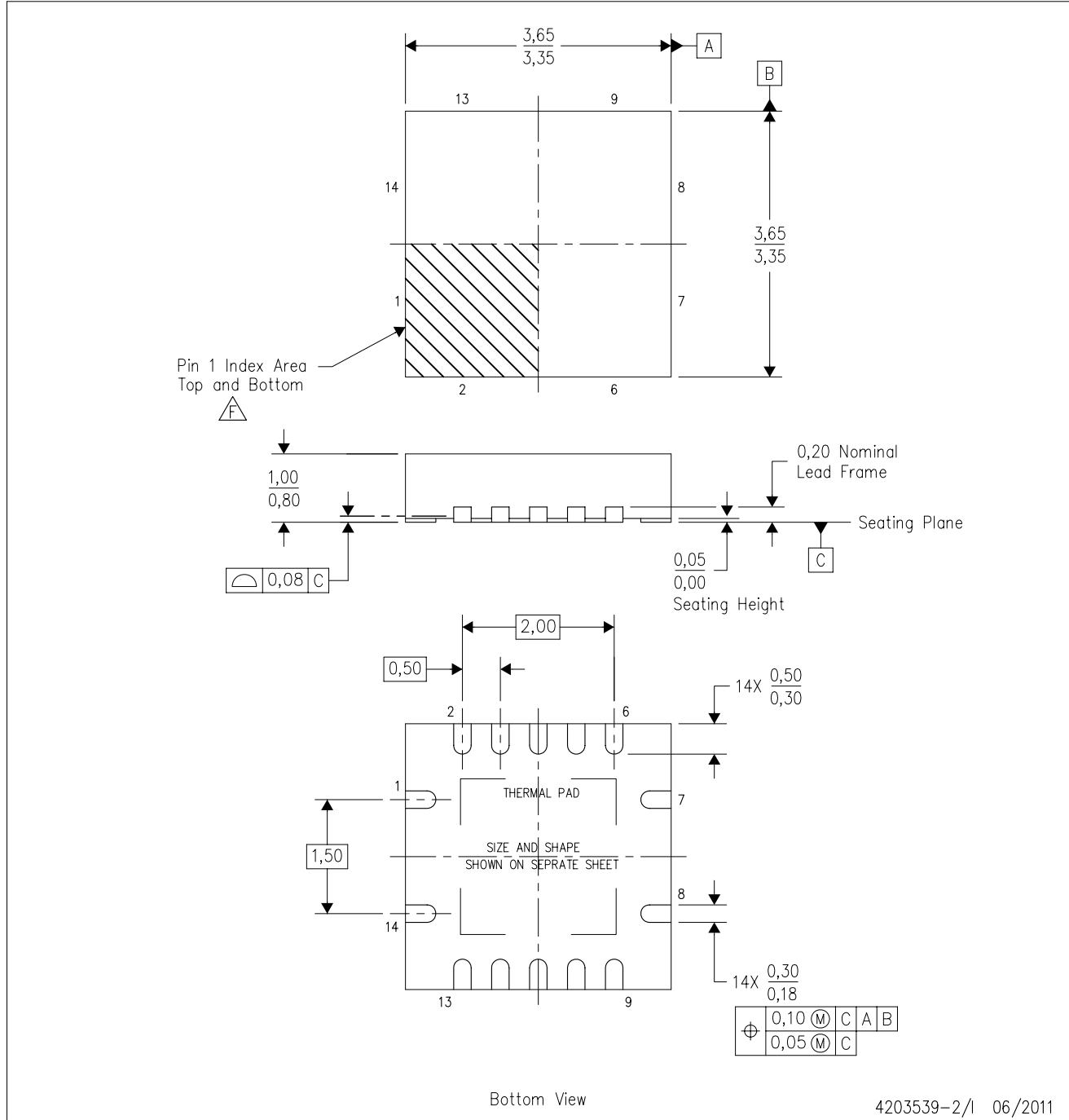

- NOTES:
- A. All linear dimensions are in millimeters. Dimensioning and tolerancing per ASME Y14.5M-1994.
  - B. This drawing is subject to change without notice.
  - C. QFN (Quad Flatpack No-Lead) package configuration.
  - D. The package thermal pad must be soldered to the board for thermal and mechanical performance.
  - E. See the additional figure in the Product Data Sheet for details regarding the exposed thermal pad features and dimensions.
  - △ Pin 1 identifiers are located on both top and bottom of the package and within the zone indicated. The Pin 1 identifiers are either a molded, marked, or metal feature.
  - G. Package complies to JEDEC MO-241 variation BA.

RGY (S-PVQFN-N14)

PLASTIC QUAD FLATPACK NO-LEAD

THERMAL INFORMATION

This package incorporates an exposed thermal pad that is designed to be attached directly to an external heatsink. The thermal pad must be soldered directly to the printed circuit board (PCB). After soldering, the PCB can be used as a heatsink. In addition, through the use of thermal vias, the thermal pad can be attached directly to the appropriate copper plane shown in the electrical schematic for the device, or alternatively, can be attached to a special heatsink structure designed into the PCB. This design optimizes the heat transfer from the integrated circuit (IC).

For information on the Quad Flatpack No-Lead (QFN) package and its advantages, refer to Application Report, QFN/SON PCB Attachment, Texas Instruments Literature No. SLUA271. This document is available at [www.ti.com](http://www.ti.com).

The exposed thermal pad dimensions for this package are shown in the following illustration.

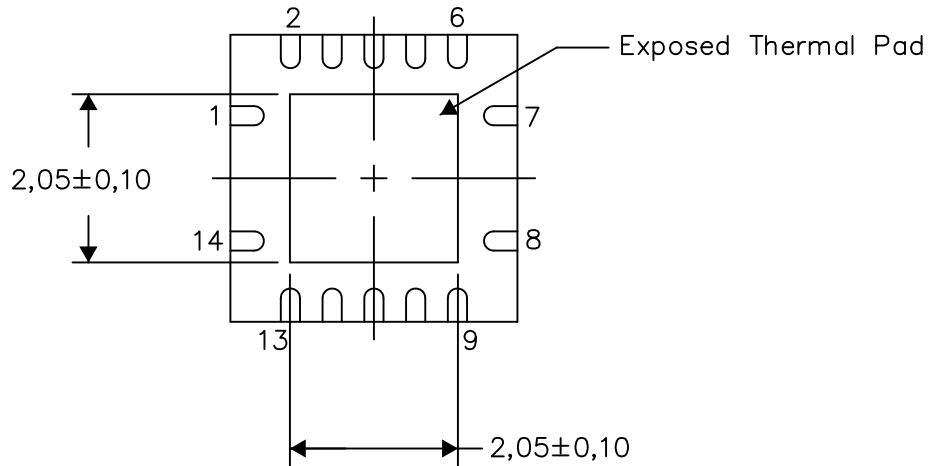

Bottom View

Exposed Thermal Pad Dimensions

4206353-2/P 03/14

NOTE: All linear dimensions are in millimeters

RGY (S-PVQFN-N14)

PLASTIC QUAD FLATPACK NO-LEAD

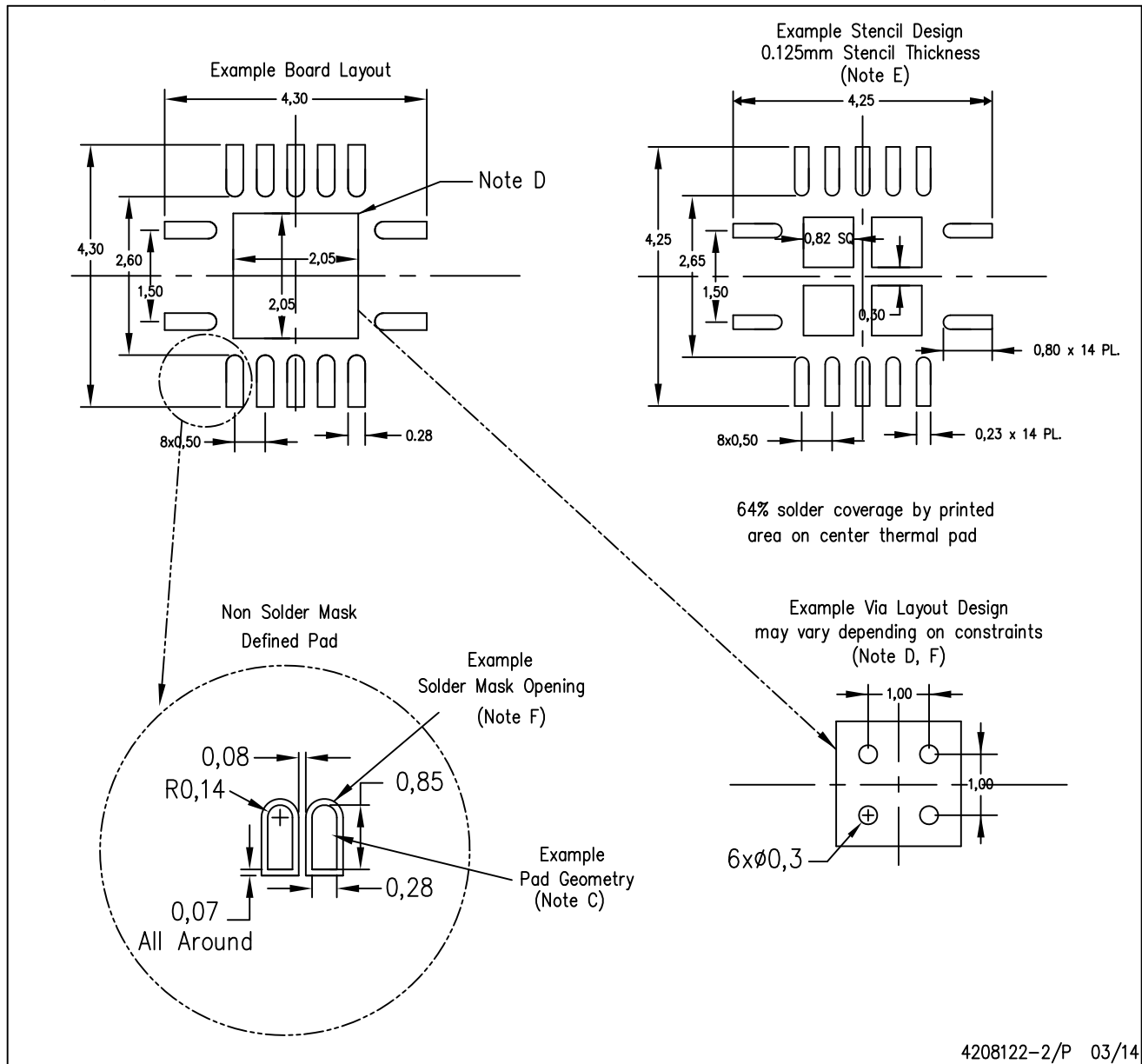

4208122-2/P 03/14

- NOTES:
- All linear dimensions are in millimeters.
  - This drawing is subject to change without notice.
  - Publication IPC-7351 is recommended for alternate designs.
  - This package is designed to be soldered to a thermal pad on the board. Refer to Application Note, Quad Flat-Pack QFN/SON PCB Attachment, Texas Instruments Literature No. SLUA271, and also the Product Data Sheets for specific thermal information, via requirements, and recommended board layout. These documents are available at [www.ti.com](http://www.ti.com) <<http://www.ti.com>>.
  - Laser cutting apertures with trapezoidal walls and also rounding corners will offer better paste release. Customers should contact their board assembly site for stencil design recommendations. Refer to IPC 7525 for stencil design considerations.
  - Customers should contact their board fabrication site for minimum solder mask web tolerances between signal pads.

## GENERIC PACKAGE VIEW

**BQA 14**

**WQFN - 0.8 mm max height**

2.5 x 3, 0.5 mm pitch

PLASTIC QUAD FLATPACK - NO LEAD

This image is a representation of the package family, actual package may vary.  
Refer to the product data sheet for package details.

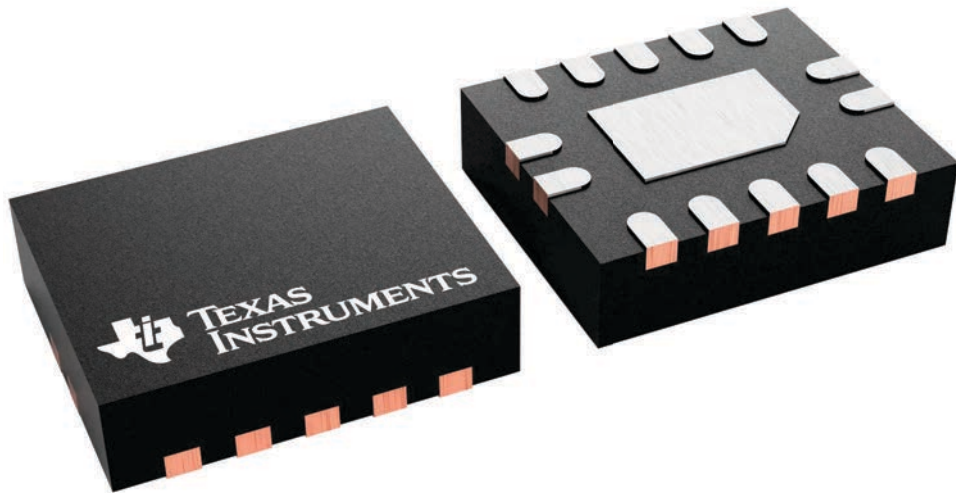

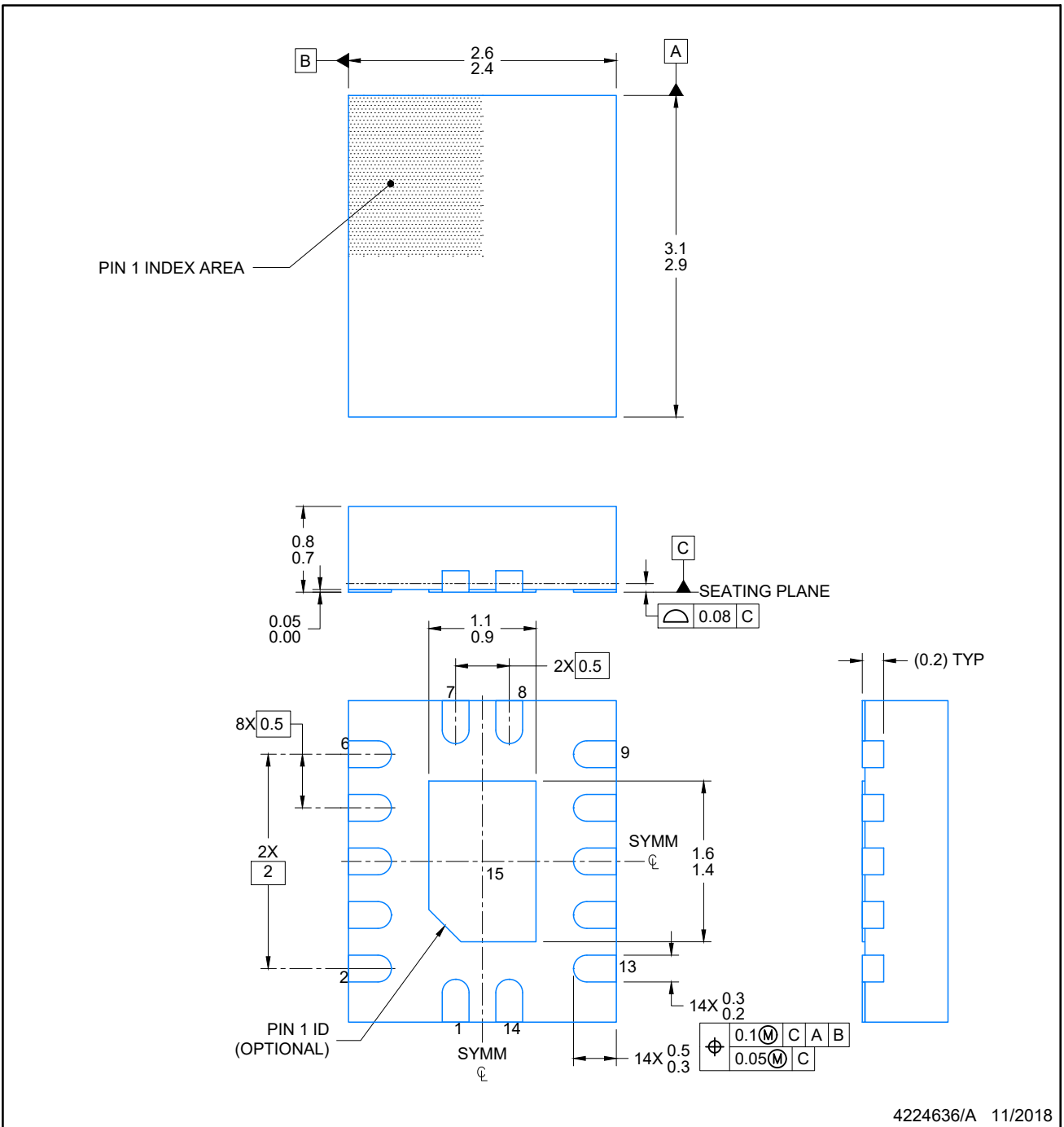

NOTES:

1. All linear dimensions are in millimeters. Any dimensions in parenthesis are for reference only. Dimensioning and tolerancing per ASME Y14.5M.
2. This drawing is subject to change without notice.
3. The package thermal pad must be soldered to the printed circuit board for optimal thermal and mechanical performance.

# EXAMPLE BOARD LAYOUT

WQFN - 0.8 mm max height

BQA0014A

PLASTIC QUAD FLAT PACK-NO LEAD

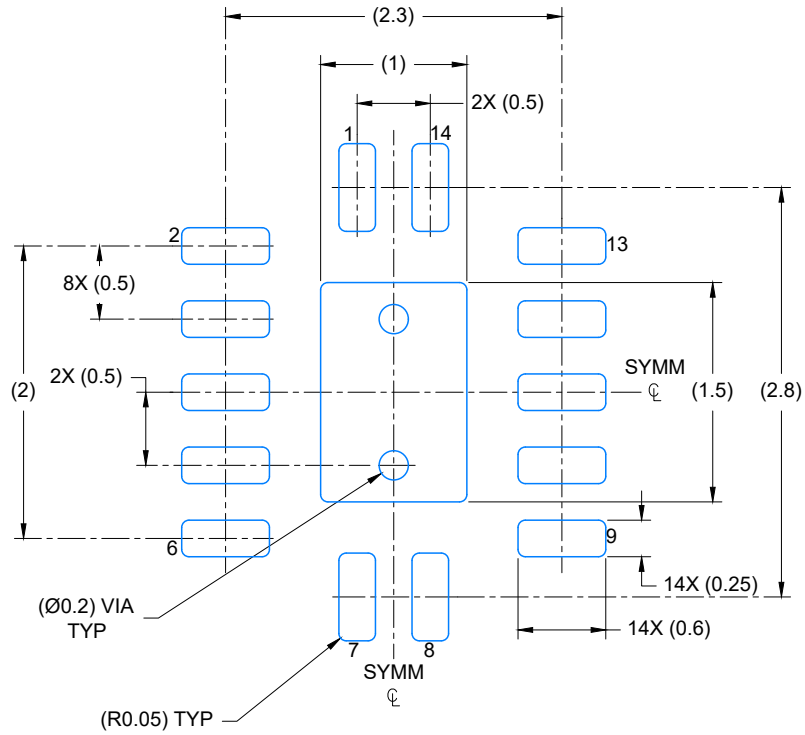

LAND PATTERN EXAMPLE  
EXPOSED METAL SHOWN  
SCALE: 20X

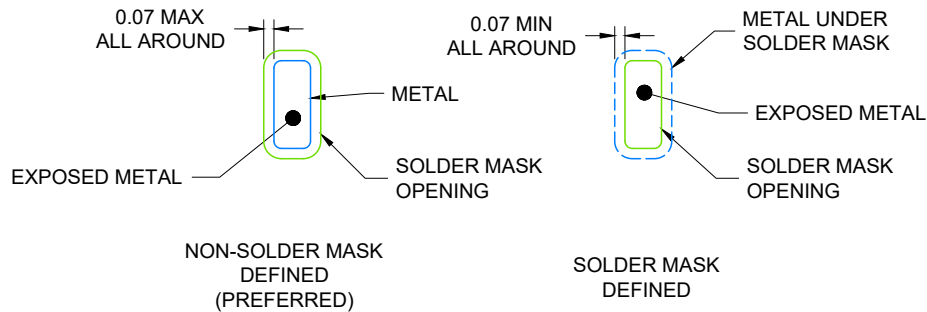

4224636/A 11/2018

NOTES: (continued)

4. This package is designed to be soldered to a thermal pad on the board. For more information, see Texas Instruments literature number SLUA271 ([www.ti.com/lit/slua271](http://www.ti.com/lit/slua271)).
5. Vias are optional depending on application, refer to device data sheet. If any vias are implemented, refer to their locations shown on this view. It is recommended that vias under paste be filled, plugged or tented.

# EXAMPLE STENCIL DESIGN

BQA0014A

WQFN - 0.8 mm max height

PLASTIC QUAD FLAT PACK-NO LEAD

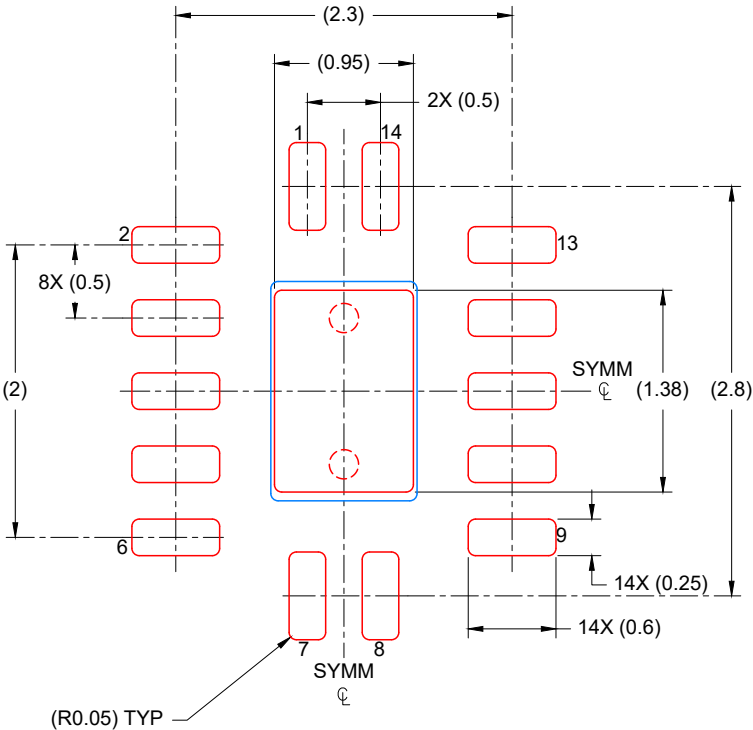

SOLDER PASTE EXAMPLE  
BASED ON 0.125 mm THICK STENCIL

EXPOSED PAD  
88% PRINTED COVERAGE BY AREA  
SCALE: 20X

4224636/A 11/2018

NOTES: (continued)

- 6. Laser cutting apertures with trapezoidal walls and rounded corners may offer better paste release. IPC-7525 may have alternate design recommendations.

# MECHANICAL DATA

NS (R-PDSO-G\*\*)

PLASTIC SMALL-OUTLINE PACKAGE

14-PINS SHOWN



- NOTES:
- A. All linear dimensions are in millimeters.
  - B. This drawing is subject to change without notice.
  - C. Body dimensions do not include mold flash or protrusion, not to exceed 0,15.

W (R-GDFP-F14)

CERAMIC DUAL FLATPACK



- NOTES:
- A. All linear dimensions are in inches (millimeters).
  - B. This drawing is subject to change without notice.
  - C. This package can be hermetically sealed with a ceramic lid using glass frit.
  - D. Index point is provided on cap for terminal identification only.
  - E. Falls within MIL STD 1835 GDFP1-F14

DGV (R-PDSO-G\*\*)

PLASTIC SMALL-OUTLINE

24 PINS SHOWN

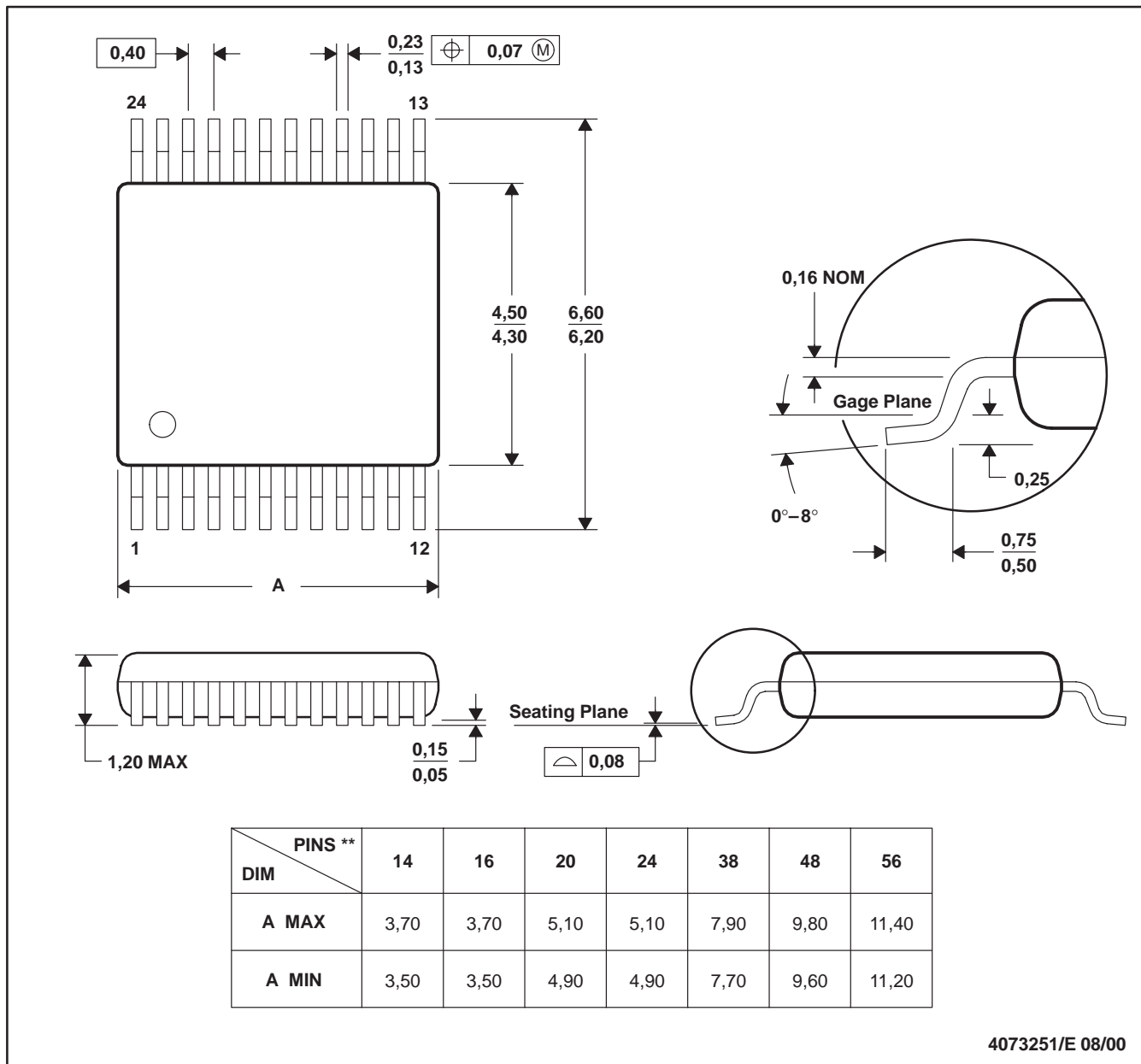

- NOTES: A. All linear dimensions are in millimeters.  
 B. This drawing is subject to change without notice.  
 C. Body dimensions do not include mold flash or protrusion, not to exceed 0,15 per side.  
 D. Falls within JEDEC: 24/48 Pins – MO-153  
 14/16/20/56 Pins – MO-194

## GENERIC PACKAGE VIEW

**FK 20**

**LCCC - 2.03 mm max height**

8.89 x 8.89, 1.27 mm pitch

LEADLESS CERAMIC CHIP CARRIER

This image is a representation of the package family, actual package may vary.  
Refer to the product data sheet for package details.



4229370VA\

J 14

**GENERIC PACKAGE VIEW**  
**CDIP - 5.08 mm max height**  
CERAMIC DUAL IN LINE PACKAGE

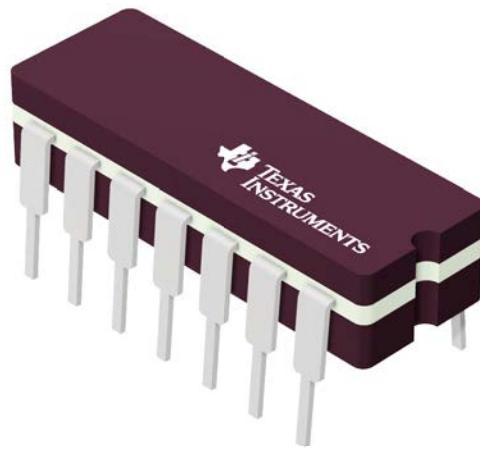

Images above are just a representation of the package family, actual package may vary.  
Refer to the product data sheet for package details.

4040083-5/G

J0014A



# PACKAGE OUTLINE

CDIP - 5.08 mm max height

CERAMIC DUAL IN LINE PACKAGE



4214771/A 05/2017

NOTES:

1. All controlling linear dimensions are in inches. Dimensions in brackets are in millimeters. Any dimension in brackets or parenthesis are for reference only. Dimensioning and tolerancing per ASME Y14.5M.
2. This drawing is subject to change without notice.
3. This package is hermetically sealed with a ceramic lid using glass frit.
4. Index point is provided on cap for terminal identification only and on press ceramic glass frit seal only.
5. Falls within MIL-STD-1835 and GDIP1-T14.

# EXAMPLE BOARD LAYOUT

J0014A

CDIP - 5.08 mm max height

CERAMIC DUAL IN LINE PACKAGE

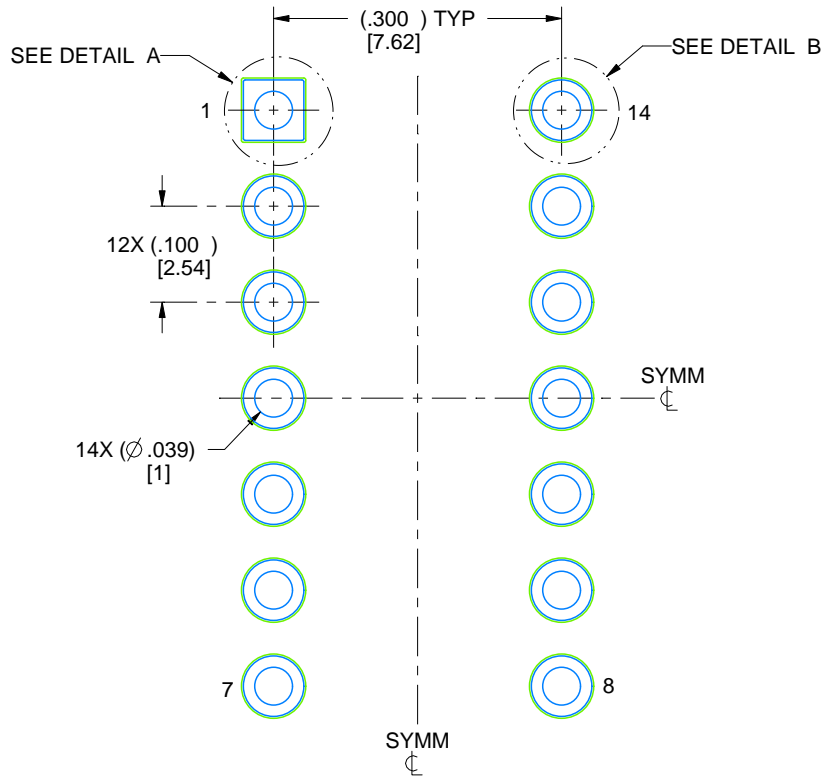

LAND PATTERN EXAMPLE  
NON-SOLDER MASK DEFINED  
SCALE: 5X





4214771/A 05/2017

D (R-PDSO-G14)

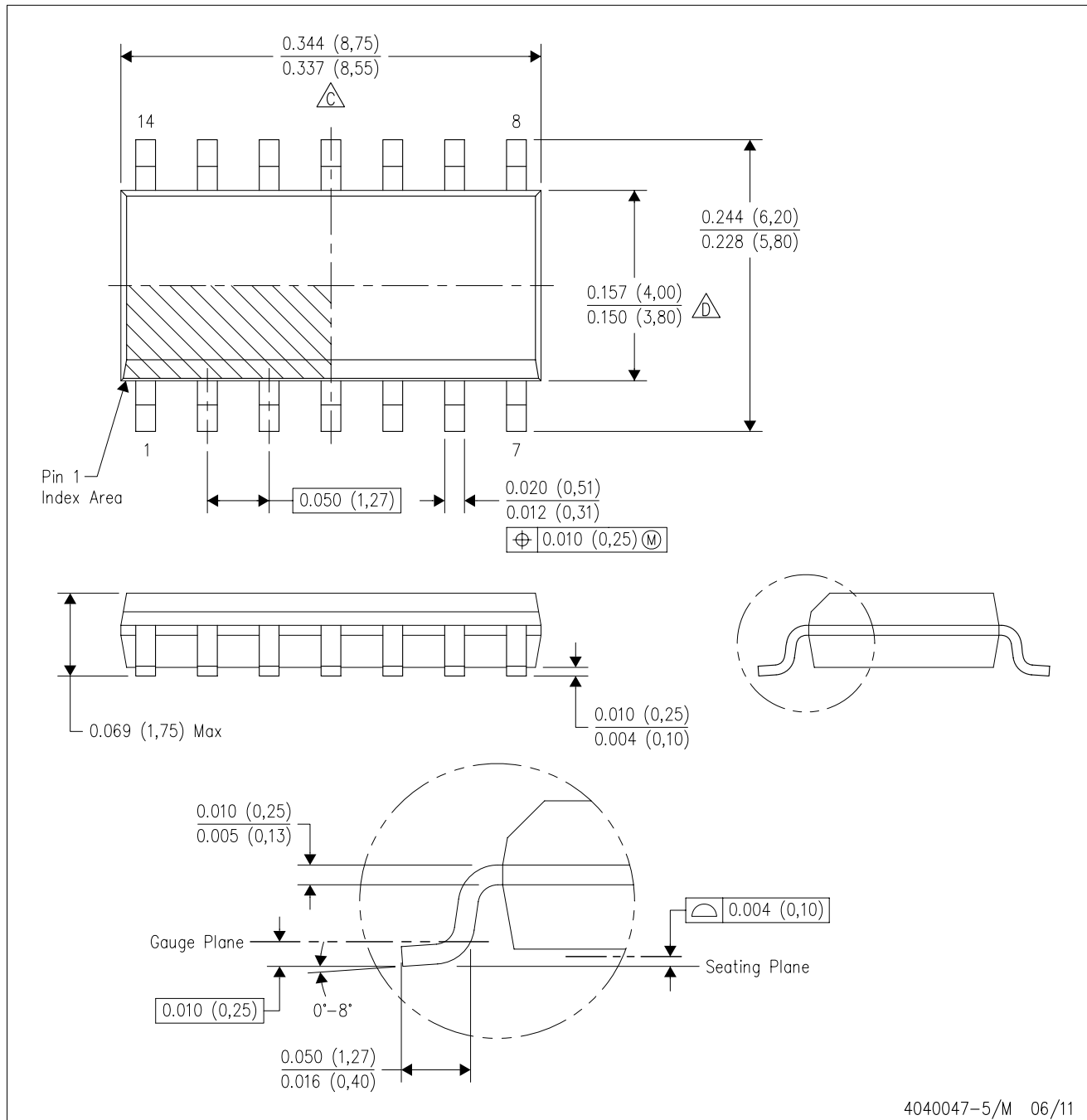
PLASTIC SMALL OUTLINE



- NOTES:
- A. All linear dimensions are in inches (millimeters).
  - B. This drawing is subject to change without notice.
  -  Body length does not include mold flash, protrusions, or gate burrs. Mold flash, protrusions, or gate burrs shall not exceed 0.006 (0,15) each side.
  -  Body width does not include interlead flash. Interlead flash shall not exceed 0.017 (0,43) each side.
  - E. Reference JEDEC MS-012 variation AB.

D (R-PDSO-G14)

PLASTIC SMALL OUTLINE

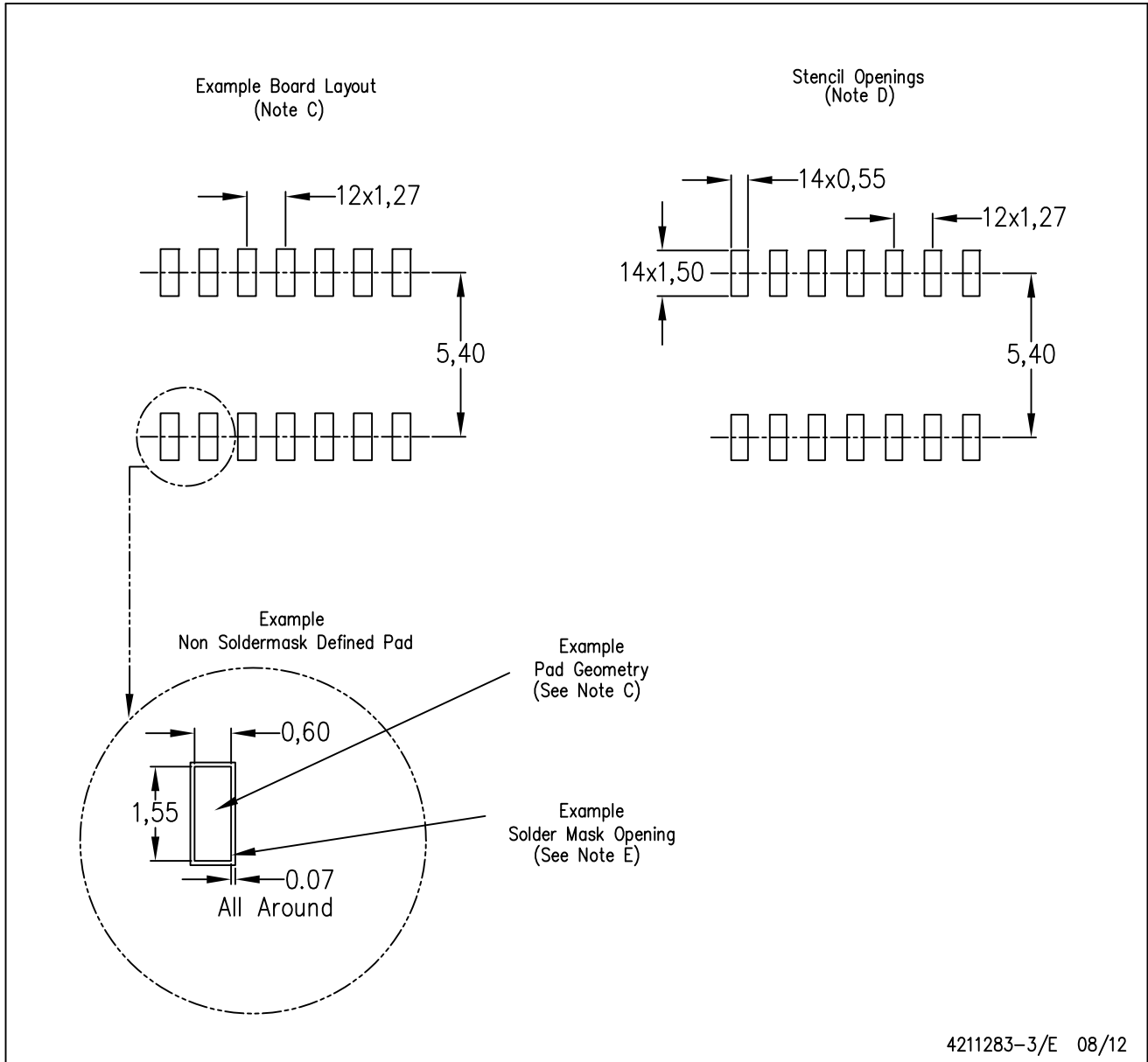

- NOTES:
- A. All linear dimensions are in millimeters.
  - B. This drawing is subject to change without notice.
  - C. Publication IPC-7351 is recommended for alternate designs.
  - D. Laser cutting apertures with trapezoidal walls and also rounding corners will offer better paste release. Customers should contact their board assembly site for stencil design recommendations. Refer to IPC-7525 for other stencil recommendations.
  - E. Customers should contact their board fabrication site for solder mask tolerances between and around signal pads.



N (R-PDIP-T\*\*)

PLASTIC DUAL-IN-LINE PACKAGE

16 PINS SHOWN



4040049/E 12/2002

- NOTES:
- A. All linear dimensions are in inches (millimeters).
  - B. This drawing is subject to change without notice.
  - (C) Falls within JEDEC MS-001, except 18 and 20 pin minimum body length (Dim A).
  - (D) The 20 pin end lead shoulder width is a vendor option, either half or full width.

DB (R-PDSO-G\*\*)

PLASTIC SMALL-OUTLINE

28 PINS SHOWN



- NOTES: A. All linear dimensions are in millimeters.  
 B. This drawing is subject to change without notice.  
 C. Body dimensions do not include mold flash or protrusion not to exceed 0,15.  
 D. Falls within JEDEC MO-150

## 重要声明和免责声明

TI“按原样”提供技术和可靠性数据（包括数据表）、设计资源（包括参考设计）、应用或其他设计建议、网络工具、安全信息和其他资源，不保证没有瑕疵且不做任何明示或暗示的担保，包括但不限于对适销性、某特定用途方面的适用性或不侵犯任何第三方知识产权的暗示担保。

这些资源可供使用 TI 产品进行设计的熟练开发人员使用。您将自行承担以下全部责任：(1) 针对您的应用选择合适的 TI 产品，(2) 设计、验证并测试您的应用，(3) 确保您的应用满足相应标准以及任何其他功能安全、信息安全、监管或其他要求。

这些资源如有变更，恕不另行通知。TI 授权您仅可将这些资源用于研发本资源所述的 TI 产品的应用。严禁对这些资源进行其他复制或展示。您无权使用任何其他 TI 知识产权或任何第三方知识产权。您应全额赔偿因在这些资源的使用中对 TI 及其代表造成的任何索赔、损害、成本、损失和债务，TI 对此概不负责。

TI 提供的产品受 [TI 的销售条款](#) 或 [ti.com](#) 上其他适用条款/TI 产品随附的其他适用条款的约束。TI 提供这些资源并不会扩展或以其他方式更改 TI 针对 TI 产品发布的适用的担保或担保免责声明。

TI 反对并拒绝您可能提出的任何其他或不同的条款。

邮寄地址：Texas Instruments, Post Office Box 655303, Dallas, Texas 75265

Copyright © 2023，德州仪器 (TI) 公司